



DMIX-ADA, Inc.



Rugged Ridge

WIN
A TRIP TO
SEMA 2010!
SEE INSIDE
BACK COVER
FOR MORE
INFO



CATALOG

REPLACEMENT - PERFORMANCE - ACCESSORIES

Table of Contents

Audio	45
Black Exterior Accessories	68 - 71
Body Armor	72 - 73
Bumpers	4 - 14
Covers	22
Door Accessories	48 - 49
Fender Flares	17 - 19
Floor Liners	32 - 33
Grab Handles	50
Headlight Treatments	66 - 67
Heavy-Duty Off Road Accessories	80 - 87
Intakes/Headers/Exhaust	92 - 93
Interior Storage	44, 51
Interior Trim	36 - 37, 62
Off Road Lighting	88 - 91
Organizers	34 - 35
Replacement Interior Accessories/Carpet	46 - 47
Replacement Mirrors	52 - 53
Seating	38 - 43
Skid Plates	80-81
Stainless/Chrome Exterior Accessories	54 - 61 64 - 66
Tops/Summer Briefs/Island Toppers	23 - 31
Tube Steps, Side Protection	9, 15 - 16
Wheels & Accessories	20 - 21
Winches & Recovery Gear	76 - 79

Brake Lines	103
Polyurethane	102 - 103
Shocks & Stabilizers	97
Suspension Kits	96 - 101

Bull Bars	107 - 108
Consoles	109
Floor Liners/Accessories	110-111
Hubs	112
Tube Steps	105 - 106

ATV/UTV Winches and Recovery	113 - 114
UTV Accessories	115 - 116

Front Axle Kits	119 - 120
Lockers	118
Rear Axle Kits	120 - 125
Ring & Pinions	126, 129 - 130
Wheel Spacers, Axle & Differential Covers	127

Axle & Differential	159 - 171
Body	132 - 158
Brakes	172 - 180
Clutch & Flywheel	181 - 183
Cooling	184 - 187
Electrical	188 - 195
Engine	196 - 202
Exhaust	203 - 206
Fuel	207 - 211
Heating & A/C	212
Steering	213 - 217
Surplus	233 - 240
Suspension	218 - 220
Transfer Case	221 - 224
Transmission	225 - 231
Wipers	232
Warranty Info	241

OWN A JEEP®?

The toughest four letter word on wheels. Are you looking for a parts source rugged enough to match your off the beaten path sense of adventure? With more than 15,000 unique part numbers from brands like Omix-ADA®, Rugged Ridge®, Alloy USA®, Outland Automotive®, ORV Suspension and Precision Gear, consider this your trail guide to the 4x4 of your dreams. A go anywhere, anytime, in any weather vehicle. Go ahead and smile, because it's going to take a lot of courage not to be cocky when you own a Jeep® like that.



WHO WE ARE

Omix-ADA is more than just a parts manufacturer, we're a community of enthusiasts dedicated to producing the finest in off-road solutions. Our products have been propelling four-wheel drive vehicles down highways, back roads and over the world's roughest terrain for over a decade. Omix's team of engineers have developed, tested and trail ridden thousands of new products until they were perfected for you.



**Did we mention we're Jeep® enthusiasts?
Just take a look at some of our rigs.**

Why have we put so much time and energy into developing the most expansive collection of Jeep® parts available under one roof? Because the items bearing our logo are more than just parts, they are built with a legacy and heritage in mind. This is why we have been authorized to use the "MOPAR Authentic Restoration" and "MOPAR Official Licensed Product" logos for the more than 30 licensed parts we produce. We take pride in being one of the few manufacturers strong enough to stand behind the legendary Jeep® name.



OFFICIAL
LICENSED
PRODUCT



AUTHENTIC
RESTORATION
PRODUCT

AWARD WINNING DESIGNS

More than 2,500 new products were displayed at the recent SEMA Show. A group of 50 journalists and industry experts were charged with the task of judging the most innovative new products introduced into the automotive industry. As the judges tallied their scores, Omix-ADA emerged as one of the most decorated companies in the off-road sector.

The Omix-ADA® Group of Companies:



Omix-ADA®: The parent company brand that offers thousands of parts and components for all Jeep® vehicles built from 1941 to current! Omix hard parts, undercarriage parts and body parts are all designed to bring your Jeep® back to life. Omix parts can be found in a separate catalog which your distributor can easily provide or feel free to go online to www.omix-ada.com. If there is a part you need for your Jeep®, there is an excellent chance that Omix can take care of you! www.omix-ada.com



Rugged Ridge® Accessories for Jeep®: Featuring the most complete line of high quality functional accessories for Jeep® vehicles. Rugged Ridge products can take you from street to trail and look good doing it. From beautiful polished stainless steel bolt on accessories to hard core off road protection and performance; Rugged Ridge has you covered. (pages 3-94)



Alloy USA®: A full line of the highest quality, high performance off road and racing alloy axles, and ring & pinions developed for the serious off road enthusiast by off road enthusiasts. Alloy USA products feature premium alloy steel for strength and durability during your hard core adventures. Each Alloy USA product includes an industry leading 3, 5 or 10 year limited warranty for the peace of mind and confidence you demand. (pages 117-128)



Outland®: If you own a truck or SUV, you need Outland Accessories. Outland features a full line of truck/SUV Tube Steps, Bull Bars, Consoles and other functional accessories to make your rig look great and perform even better. (pages 105-112)



ORV™ Suspensions: Designed by Jeep® enthusiasts for Jeep® vehicles! ORV offers a full line of heavy duty suspension options to upgrade your vehicles off road capabilities. Each kit is specially designed for the Jeep® enthusiast and can be custom tailored for your particular needs. Get the ORV advantage (pages 95-104)



Precision Gear®: Drive train engineering perfected! Precision Gear offers a full line of heavy duty up-graded ring and pinion sets to make your vehicle run as efficiently as possible. Precision Gear products are made from only the highest quality materials and designs and offers a full range of applications for both on and off road vehicles. From street to trail, when only the best will do, look to Precision Gear Ring and Pinion sets! www.precisiongear.com



Please see pages 95, 104, 131, and inside back cover for important safety and warranty information for the products offered by the Omix-ADA® Group of Companies.

IF YOU KNOW JEEP®, YOU KNOW OMIX-ADA® /RUGGED RIDGE®!

XHD Modular Bumper System

The most advanced, toughest, most flexible bumper system ever created!

No other bumper can give your Jeep® this many looks. Modular design provides dozens of different looks and styles. You can build the exact bumper of your choice! Custom designed for the 1976-2010 Jeep® Wrangler & CJ, each component maximizes the oversized look of the vehicle. All components are constructed of heavy-duty textured black powder coat steel with a tough E-Coat under-coating or polished, no rust, prime 304 stainless steel for the ultimate look! These tough finishes will provide years of heavy-duty use. Matching rear bumpers are available for a complete look.



XHD Bumper System

XHD Bumper System (Textured Black)	Part #
Short Base, Winch Mount, Textured Black D-Rings, 76-06 CJ & Wrangler	11540.40
Short Base, Winch Mount, Textured Black D-Rings, 07-10 Wrangler	11540.10
Short Base, Light Mount, Textured Black D-Rings, 07-10 Wrangler	11540.11
RRC Mount, 2.5" Tube, Textured Black for XHD Bumper, 76-06 CJ & Wrangler	11540.48
RRC Mount, 2.5" Tube, Textured Black for XHD Bumper, 07-10 Wrangler, 76-06 CJ & Wrangler w/7" Flares	11540.18
Stinger Over-Rider, 2" Textured Black for XHD Bumper, 76-10 CJ & Wrangler	11540.13
Hoop Over-Rider, 60mm Textured Black for XHD Bumper, 76-10 CJ & Wrangler	11540.14
Standard Ends, Textured Black for XHD Bumper, 76-06 CJ & Wrangler	11540.42
Standard Ends, Textured Black for XHD Bumper, 07-10 Wrangler	11540.12
Storage Ends, Textured Black for XHD Bumper, 07-10 Wrangler (NEW)	11540.22
Tube Ends, Textured Black for XHD Bumper, 07-10 Wrangler (NEW)	11540.21
D-Rings, Pair For Use With Stinger & RRC D-Ring Mounts, 76-10 CJ & Wrangler	11235.01
Mounting Plates For Warn Power Plant Winch (for use on 11540.10 XHD Bumper only)	11540.15

XHD Storage Ends

11540.22
Storage Ends,
Black



NEW!

Looking for an easily accessible yet secure storage solution for your Wrangler? XHD Storage Ends from Rugged Ridge turn your bumper into a stylish watertight storage vault. The XHD Storage ends are a great place to stow recovery gear and other valuables. Beefy steel construction, a watertight seal, and lockable lid helps keep mud and water out and your gear in.



NEW!

XHD Tube ends

Add tube ends to your XHD bumper for added protection and a classic OE look! XHD Tube Ends offer wraparound protection and added clearance for oversized tires. Available in either textured black powder coat or polished 304 stainless steel for a long lasting durable finish.

XHD Tube Ends	Part #
Tube Ends, Textured Black for XHD Bumper, 07-10 Wrangler (NEW)	11540.21
Tube Ends, Stainless Steel for XHD Bumper, 07-10 Wrangler (NEW)	11540.73

Also Available in Stainless for a Whole New Look!

Nothing lasts as long or stands up to the elements like stainless steel. Not only do you get a bright shiny finish, but the long lasting durability of prime 304 stainless!

XHD Bumper System (Stainless Steel)	Part #
Short Base, Light Mount, Stainless Steel, Stainless D-Rings, 07-10 Wrangler* Each	11540.71
Hoop Over-Rider, 60mm Stainless for XHD Bumper, 76-10 CJ & Wrangler** Each	11540.16
Standard Ends, Stainless for XHD Bumper, 07-10 Wrangler Each	11540.19
Tube Ends, Stainless for XHD Bumper, 07-10 Wrangler Each (NEW)	11540.73
Polished Stainless D-Rings, Replaces Standard XHD D-Rings, 76-10 CJ & Wrangler Pair	11540.17

* Includes Stainless D-Rings ** Will not work with Warn Power Plant Winch.



JK

XHD Bumper System

Build the Ultimate XHD!

Need more front-end protection? No problem! Need to mount up a quartet of lights to chase away the night? No problem! Need more clearance for rock crawling? No problem! Now available in polished stainless steel for the ultimate look! Only the XHD Bumper from Rugged Ridge can give you this many options while providing the quality you demand.

STEP 1 Select Your Base - Upgrade Any Time

The XHD Short Base comes in two designs; Integrated Winch Mount for use with almost any aftermarket winch (including the new Warn Power Plant with optional mounting blocks #11540.15) and for the 2007-10 Wrangler, a Light Mount Base with two light mounting locations. The Short Base attaches quickly with two enclosed D-Ring mounting brackets. This eight bolt frame mount design provides the toughest bumper attachment found anywhere while creating two overbuilt pull points. The 76-06 CJ/YJ/TJ XHD matches the look and utility of the 07-10 JK XHD but does not include the fog light cutouts and is only available with a winch mount. This bumper mounts close in on the frame rails, drawing the bumper closer to the body allowing for an increased approach angle. The narrow overall width gives enormous clearance for the front tires. Each JK Short Base includes two protected cut outs for your JK's factory fog lamps. All Short Bases includes side filler plates to close off the ends for a finished look.



STEP 2 Select Your Ends - Turn Your Short Base Into A Full Size Bumper

Standard ends easily mount to any Short Base with six oversized 12mm bolts to turn your short bumper into a full size bumper design. Each Standard end is recessed to provide the ultimate seamless fit. Storage ends and tube ends also available, more details on page 4.



STEP 3 Select Your Tubes - Tough Tubular Options Provide Off Road Protection

Add on a durable .120 wall tubular RRC mount, Stinger or Hoop Override to create the ultimate off-road bumper. These are some tough tubes! The Stinger and RRC mounts use a unique D-ring attachment so you will need separate optional D-rings (part no. 11235.01). The enclosed HD D-rings on the short base will not be used with these two tubular options.

Why two different RRC Mounts? For 1976-2006 CJ, YJ and TJ's with Rugged Ridge 7" oversize fender flares, the JK RRC Mount is wider and matches the look of the wider flares. For CJ's, YJ's and TJ's with stock width fender flares, the 11540.48 RRC Mount is designed to match the width of the factory flares.



XHD Bumpers Continued on Next Page...

It's Over 100 Bumpers In One!

That's right, over 100 different bumpers! You won't find a more versatile bumper system. Go from hardcore to street savvy with just a few hand tools.



Short Front Winch Mount With Stinger:
11540.10, 11540.13, 11235.01



Short Front Winch Mount: 11540.10



Short Front Winch Mount With Override Hoop:
11540.10, 11540.14



Standard Front Winch Mount With Override Hoop:
11540.40, 11540.14, 11540.42



Standard Front Winch Mount With Stainless D-rings & Stainless Override Hoop:
11540.40, 11540.16, 11540.17, 11540.42



Standard Front Winch Mount:
11540.40, 11540.42

NEW Online Build A Jeep® Application! www.ruggedridgeoffroad.com



1. CHOOSE YOUR PAINT



2. PICK YOUR WHEELS



3. SET YOUR LIFT



4. DESIGN YOUR BUMPER



Xtreme Heavy-duty (XHD) Rear Bumper System For 2007-10 Wrangler

Make the most of your rear bumper with our XHD Rear Bumper System. Features easy installation, amazing looks and two reinforced heavy-duty D-Ring attachment points. Special "inner mounting plate" provides an extremely secure mounting point - strong enough for off-road use! The two-piece design allows use with and without tire carrier options. Heavy-duty powder coated steel design looks great but is extremely tough. Mount on the optional Tire Carrier and you can hold up to a 35" tire.



11546.20 XHD Rear Bumper



11546.20 XHD Rear Bumper



Heavy-duty D-Ring attachment points are strong enough for off-road use!



D-rings attach securely to the frame of the vehicle for a rock solid recovery mounting point.

eXtreme Heavy-Duty Rear Bumper

Rear XHD Bumper, Textured Black, 07-10 Wrangler, Each

Tire Carrier Mount Add-on for 11546.20, Textured Black 07-10 Wrangler, Each

Part

11546.20

11546.22

XHD Tire Carrier Mount For 2007-10 Wrangler



The perfect addition to the XHD rear bumper is the matching XHD Tire Carrier Mount. The latch uses a sturdy locking mechanism for security and a tough appearance. Our engineers have gone to great lengths to make this the quietest tire carrier on the market, no more rattling! The massive hinge pivots on a heavy-duty roller bearing and supports up to a 35" tire. A multi-position locking pin mechanism keeps the arm in the open position when you need to open the tailgate, even on the steepest grade. The XHD Tire Carrier Mount attaches to the XHD Rear Bumper using the D-ring mounts for a solid foundation.

JK



Over Center Latching Mechanism With An Attached Security Pin Keeps Your Carrier Secure

Includes Bolt On Third Brake Light Extension



11546.22 Tire Carrier Mount



The Massive Tapered Greasable Roller Bearing Hinge Supports Up To a 35" Tire.



A Locking Pin Keeps The Arm In Place, Even On The Steepest Grade.

eXtreme Heavy-Duty Rear Bumper

Part

Rear XHD Bumper, Textured Black, 07-10 Wrangler Each	11546.20
Tire Carrier Mount Add-on for 11546.20, Textured Black 07-10 Wrangler Each	11546.22

Tire Carrier Linkage

Has opening your rear tailgate become a burden since you added a swing out tire carrier? Has it become easier to crawl over the rear seat, to grab your gear, than hassling with the tire carrier? The Rugged Ridge Tire Carrier Linkage Kit eliminates the issue and makes accessing the cargo area quick and painless. Once installed the linkage mates the tire carrier to the tailgate, so both open in a single fluid movement. The Tire Carrier Linkage is designed to work with Rugged Ridge XHD, RRC and Rock Crawling rear bumpers and tire carriers, but will also work with most other aftermarket tire carriers. No drilling is required to mount the linkage to the tailgate, but some minor drilling is required to mount the linkage to the tire carrier.



JK

NEW!

Tire Carrier Linkage

Part

Tire Carrier Linkage, 87-06 Wrangler (TJ-YJ) (NEW)	11503.90
Tire Carrier Linkage, 07-10 Wrangler (JK) (NEW)	11503.91

RRC Rock Crawling Bumpers

Introducing the toughest, most durable off-road tube bumpers ever made! The Rugged Ridge Rock Crawling Bumpers (RRC) feature heavy-duty .120 wall 2" steel tubing treated with a special "E-Coating" and then dual stage powder-coated to ensure long life and a no-rust finish. These overbuilt tube bumpers not only look good but they are built to last! All RRC designs have been developed with true off-road enthusiasts in mind. From the reinforced welds to the built-in D-ring attachments, these bumpers and side guards are built to take what ever the trail throws at you.

RRC Front Grille Guards

The RRC Front Grille Guard is an easy to install front bumper system that offers an expanded opening for use with a winch (winch plate not included) or with up to four off-road lights. The RRC side supports elevate the tube upwards to provide fender protection while not altering the side clearance. Two reinforced D-ring attachments allow for easy use of optional D-rings (part no. 11235.01).



11502.12 RRC Front Grille Guard, Titanium



11502.11 RRC Front Grille Guard, Textured Black

RRC Front Grille Guard	Textured Black	Titanium
87-06 Wrangler Each (1)	11502.11	11502.12

(1) Including Wrangler Unlimited

RRC Rear Bumpers

Rugged Ridge offers two RRC bumper options for the rear of your Jeep®. Both options work off a similar frame mounted platform that features a heavy-duty grid like system with raised sides for the ultimate protection and greatest ground clearance. All RRC Rear Bumpers also feature a reinforced hitch box that is designed for off-road accessories (not designed or rated for towing. Use only for accessories). The heavy-duty rear tire carrier model mounts your tire off the rear bumper taking the load off your tailgate. With a reinforced grease fitting and special latching mechanism, this tire carrier is capable of holding up to a 35" tire.



11503.15 RRC Bumper with Hitch for 07-10 Wrangler



11503.15 RRC Bumper with Hitch for 07-10 Wrangler



11503.13 RRC Rear Bumper with Tire Carrier



11503.11 RRC Bumper with Hitch for 87-06 Wrangler

RRC Rear Bumpers		Textured Black
07-10 Wrangler (1)	RRC Rear Bumper w/Hitch Each	11503.15
87-06 Wrangler (2)	RRC Rear Bumper w/Hitch Each	11503.11
87-06 Wrangler (2) (3)	RRC Rear Bumper w/Tire Carrier Each	11503.13

(1) Fits 2 & 4-Door Wrangler (2) Including Wrangler Unlimited (3) Ships in 2 boxes

CAUTION: Receiver not designed or rated for towing. Use only for accessories (bike rack, etc.)

Tire Carrier Recovery (TCR) Bag

The TCR bag has been designed to mount to Rugged Ridge RRC, XHD & Classic rear tire carrier bumpers. This bag allows the storage of all your recovery gear between the A-frame uprights on your rear tire carrier. Constructed of weather resistant material & features a zipper flap to help protect your gear from the environment. Attaches easily with 4 heavy-duty nylon straps that allow for quick removal and transport.

Tire Carrier Recovery Bag (Each)	Part #
TCR Bag Fits RRC, XHD and Classic Rear Bumpers with Tire Carrier	12801.50



Carries Recovery Gear (not included)



Removable with Handy Carry Handle

RRC Side Armor

Keep your rocker panels from being beaten to a pulp on the trail with Rugged Ridge's Side Armor. Built from heavy-duty 2" x 0.120" black texture powder coated steel tubing, these guards will take the beating that was meant for your sheet metal. JK models feature a simple bolt-on design that utilizes existing body mount locations for a secure, rattle free installation. YJ and TJ models require drilling. The black texture finish resists scratches and gives a slip-resistant surface for door entry. Sold as a pair and includes all necessary installation hardware.



11054.20 RRC Side Armor, Textured Black, 07-10 4-Door Wrangler

JK



11504.13 RRC Side Armor, Textured Black, 87-06 Wrangler

RRC Side Armor	Textured Black
07-10 Wrangler, 4-Door Pair	11504.20
07-10 Wrangler, 2-Door Pair	11504.21
87-06 Wrangler Pair	11504.13



2" x .12" Wall Construction, Black Texture Powder Coat Finish

11504.13 RRC Side Armor, Textured Black, 87-06 Wrangler with Hardware

Resists Scratches & Is Slip Resistant



07-10 Wrangler models have simple bolt on design. Utilizes existing body mount locations on frame.

RRC Rock Sliders

This true Rock Crawling design puts protection tight up under the side of your Jeep® while adding a special side "hoop" to block those large outcroppings. Special frame mounted design provides secure, bounce-free installation while keeping the mounting points above the bottom of the frame for greater ground clearance. New 07-10 models attach to the body frame mounts for a tough no-drill installation.

Frame Mounted Design
Eliminates Bounce



11504.11 RRC Rock Sliders, Textured Black, with Hardware, 87-06 Wrangler



11504.11 RRC Rock Slider, Textured Black, 87-06 Wrangler



JK

11504.22 RRC Rock Slider, Textured Black, 07-10 4-Door Wrangler



11504.23 RRC Rock Slider, Textured Black, 07-10 2-Door Wrangler

RRC Rocker Guards	Textured Black
07-10 Wrangler 4-Door Pair	11504.22
07-10 Wrangler 2-Door Pair	11504.23
87-06 Wrangler Pair	11504.11

Front Tube Bumpers For 2007-10 Wranglers



11561.10 Front Bumper, Textured Black w/ Winch Cut-Out, 07-10 Wrangler

Rugged Ridge Bumpers and Side Tube Steps have been engineered to the industry's most exacting specifications. All powder coated Rugged Ridge bumper products are "E-coated" to ensure a no rust finish. Rugged Ridge Bumpers and Side Steps can take small rock chips and still maintain their rust protection. All Rugged Ridge Front and Rear Bumpers feature smooth ground welds for an unbelievable look and further rust protection. This exclusive smooth grind process virtually eliminates small weld "pockets" that never seem to get full paint coverage and tend to rust over time. Each front bumper has two welded light tabs to easily mount off-road lighting. Need to mount a winch on your Jeep®? The winch mount version of the Rugged Ridge Front Tube Bumper features a special winch cut out to clear the roller fairlead. Finally, all Rugged Ridge Bumpers feature welded end caps rather than plastic end caps.



Front Bumpers	Front Bumper with Riser	Black	Textured Black	Stainless
07-10 Wrangler *	Front Tube Bumper w/Riser Each	-	11561.10	11563.10
07-10 Wrangler * (1)	Front Bumper w/Winch Cutout Each	-	11561.11	-
For All Tube Bumpers	License Plate Mounting Bracket Each	11503.80	-	-
For All Tube Bumpers	Light Mounting Bracket Each	11503.81	-	-
For All Tube Bumpers	CB Antenna Mounting Bracket Each	11503.88	-	-

* Fits 2 & 4-Door. 2007-10 Wranglers have cut-outs for OE foglamps. (1) Winch mount plate included. (2) Winch mount plate not included.

JK Stubby Tube Bumper

Rugged Ridge has taken their industry leading Front Tube Bumper and re-designed the ends to make the ultimate high clearance off-road winch bumper. This unique design has a built-in winch mount and special cut-outs for the JK Wrangler factory fog lamps. Like our regular tube bumper, we have cut into the front tubing allowing the bumper to "hug" the front end of the Jeep. Each bumper includes durable welded end caps and polished smooth welds for the ultimate in durability. NEW: Special inside pre-coat eliminates any chance of interior rusting. A Rugged Ridge Exclusive!



Stubby Tube Bumper	Part #
Stubby Tube Bumper, 07-10 Wrangler (JK) Each (NEW)	11561.12



Bull Bars for 07-10 Wrangler

Get that heavy-duty look with a Bull Bar from Rugged Ridge! Each design has been custom designed for your JK Wrangler utilizing tough 3/8"-1/4" thick heavy-duty mounting brackets. Each Bull Bar offers smooth ground welds and laser cut skid plates. The black model has a dual stage powder coat finish with a tough E-coat under coating. The polished stainless version has been polished to a mirror finish providing a beautiful look on your Jeep®.

Bull Bars For 07-10 Wrangler	Part #
3 Inch Black Powder Coated Each	82001.27
3 Inch Stainless Steel Each	82501.27

Pre-drilled light tabs for off-road light mounting.

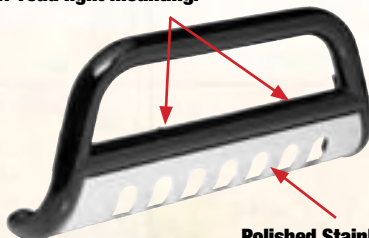

Polished Stainless Steel Skid Plate.



Front Tube Bumpers For 1976-06 CJ, Wrangler & Cherokee



Welded End Caps



Polished Welds



Black

Textured Black

Stainless

Front Bumpers	Front Bumper with Riser (Each)	Black	Textured Black	Titanium	Stainless
76-06 CJ, Wrangler **	Front Tube Bumper w/Riser	11560.01	11561.01	11562.01	11563.01
76-06 CJ, Wrangler ** (1)	Front Bumper w/Winch Cutout	11560.03	11561.03	11562.03	11563.03
76-06 CJ, Wrangler **	Front Tube Bumper w/o Riser	11560.02	11561.02	-	-
84-96 Cherokee XJ	Front Bumper w/Riser	11560.80	-	-	-
For All Tube Bumpers	License Plate Mounting Bracket	11503.80	-	-	-
For All Tube Bumpers	Light Mounting Bracket	11503.81	-	-	-
For All Tube Bumpers	CB Antenna Mounting Bracket	11503.88	-	-	-

** Including Wrangler Unlimited. (1) Winch mount plate not included.

All Rugged Ridge Front and Rear Bumpers feature smooth ground welds for an unbelievable look and further rust protection. No other tubular bumper manufacturer goes to the expense of smooth grinding their welds. This exclusive smooth grind process virtually eliminates small weld "pockets" that never seem to get full paint coverage and tend to rust over time. Finally, all Rugged Ridge Bumpers feature welded end caps rather than plastic end caps. Gone are the days of constantly replacing those lost tube bumper end caps after a long day on the trail.



11561.03 Front Tube Bumper with Winch Cut-Out, Black Textured

11560.02 Front Bumper without Riser, Black



11560.03 Front Bumper with Winch Cutout, Black, 76-06 CJ & Wrangler

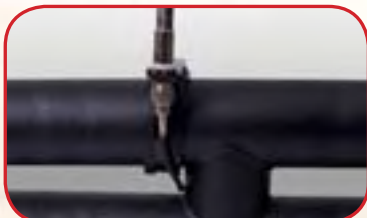

11503.88 CB Antenna Mounting Bracket



11503.81 Light Bracket



11503.80 License Plate Mounting Bracket

Front Tube Bumpers For 1976-06 CJ, Wranglers & Cherokee

Rear Tube Bumpers for 1955-2006 Jeep®

Rear Bumpers have a larger 17" rear opening allowing the use of oversized tires (up to 31") on the factory spare tire mount. This is a Rugged Ridge exclusive! Rugged Ridge Rear Tube Bumpers also feature an frame mounted hitch option that allows for lightweight towing (2,000lb towing weight, 200lb tongue weight capacity). Most other rear tube bumpers with integrated hitch boxes do not recommend towing, therefore making the hitch box virtually useless.



Rear Tube Bumper For 2007-10 Jeep® Wrangler

Get the off-road look with a Rugged Ridge Tube Bumper! Each bumper has smooth ground welds, welded end caps (not plastic end caps!) and the unique style only available from Rugged Ridge. Center tire cut-out allows for larger tires while still keeping that off-road look, accommodates tire sizes up to 35". Each rear tube bumper includes a special UV treated textured plastic filler plate to fill in the gap between the body and the bumper, a Rugged Ridge exclusive.



Rear Bumpers		Black	Textured Black	Titanium	Stainless
07-10 Wrangler (1)	Rear Tube Bumper Each	-	11571.10	-	11573.10
87-06 Wrangler (2) (3)	Rear Tube Bumper with Hitch Each	11570.04	11571.04	11572.04	11573.04
87-06 Wrangler (2)	Rear Tube Bumper Each	11570.03	11571.03	11572.03	11573.03
55-86 CJ (3)	Rear Tube Bumper with Hitch Each	11570.02	11571.02	-	-
55-86 CJ	Rear Tube Bumper Each	11570.01	11571.01	-	-
84-96 Cherokee	Rear Tube Bumper Each	11570.80	-	-	-
Rear Hitch, JK (4)	Rear Hitch for 07-10 Wrangler Each	11580.10	-	-	-
Rear Hitch, CJ (5)	Fits Part #'s 11570.01, 11571.01 Each	11580.01	-	-	-
Rear Hitch, YJ, TJ (5)	Fits Part #'s 11570.03, 11571.03, 11572.03, 11573.03 Each	11580.02	-	-	-

(1) fits 2 & 4-Door JK (2) also fits Wrangler unlimited (3) comes in 2 boxes (4) 3500 lb. towing weight, 350 lb. tongue weight (5) 2000 lb. towing weight, 200 lb. tongue weight. Will not fit YJ Renegade models.

Heavy-duty Rock Crawling Bumpers



11545.01 Heavy-Duty Front Rock Crawling Bumper



11546.01 Heavy-Duty Off-Road Rear Bumper, Black

The front bumper is a winch ready design that can accommodate any winch (winch mounting plate not included). E-Coat undercoating with a powder coat finish for the ultimate in rust protection and durability. Two welded D-ring tabs allow for easy installation of optional D-rings providing a secure pulling point. Sloped ends allow for greater off-road clearance and a great look. Rear Bumper has an accessory hitch box (not designed for towing) to mount optional accessories. This tough bumper set can take what the trail throws at you!

Heavy-duty Rock Crawling Bumpers	Black
----------------------------------	-------

97-06 Wrangler/Unlimited * Front Each	11545.01
97-06 Wrangler/Unlimited * Rear Each	11546.01

CAUTION: Receiver not designed or rated for towing. Use only for accessories (bike rack, etc.).

Heavy-Duty Bumper w/Front Armor

Looking for that over-built extra tough look for your Jeep®? This exciting new winch ready bumper provides all you could want and more. Constructed of durable powder coat painted steel plate with rugged 2"x.120 wall tubing, this bumper has what it takes for rough and tumble off-road use. With a pre-cut front section and mounting points for a roller fairlead or Hawes fairlead, this bumper will accommodate most winches. Two welded D-ring tabs allow for ease installation of optional D-rings providing a secure pulling point. Trail tested, this is a great front bumper!

Heavy-duty Bumper w/ Front Armor	Gloss Black
----------------------------------	-------------

97-06 Wrangler/Unlimited, Each	11540.01
--------------------------------	----------

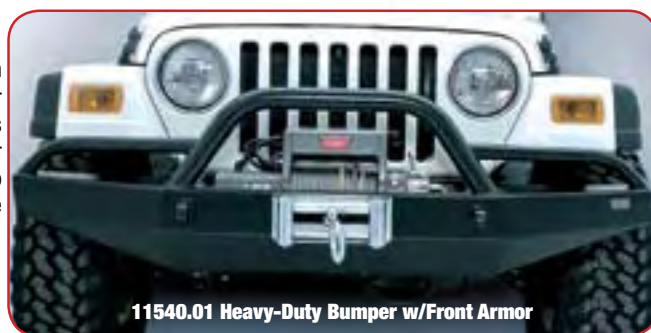

11540.01 Heavy-Duty Bumper w/Front Armor



Classic Rock Crawling Front Bumper

Looking for an economical yet tough bumper for those weekend adventures? The Classic Rock Crawling bumper series give you protection an understated good looks at an affordable price. All Classic Rock Crawler Bumpers are constructed of powder-coat painted steel with formed ends for greater ground clearance.

Classic Rock Crawling Front Bumper	Textured Black
------------------------------------	----------------

87-06 Wrangler/Unlimited, Each	11502.20
--------------------------------	----------

Classic Rock Crawling Rear Bumpers

Rugged Ridge offers two Classic options for the rear of your Jeep®. Both options work off a similar frame mounted platform that features an over built steel design with raised sides for the ultimate protection and greatest ground clearance. All Classic Rear Bumpers also feature a reinforced hitch box that is designed for off-road accessories (not designed for towing). The heavy-duty rear tire carrier model mounts your tire off the rear bumper taking the load off your tailgate. With a reinforced grease fitting and special latching mechanism, this tire carrier is capable of holding up to a 35" oversized tire.



Classic Rock Crawling Rear Bumper	Textured Black
-----------------------------------	----------------

87-06 Wrangler/Unlimited, Bumper Only, Each	11503.20
87-06 Wrangler/Unlimited, Bumper w/Tire Carrier, Kit *	11503.21
TCR Bag Tire Carrier, Recovery Bag, Each	12801.50

11503.21 Classic Rock Crawler Bumper with Rear Tire Carrier

* Ships in two boxes **CAUTION:** Receiver not designed or rated for towing. Use only for accessories (bike rack, etc.).

Euro Style Brush & Grille Guards

Designed to protect your vehicles front end from small tree limbs and brush, this stylish addition to your factory front bumper or upgraded Rugged Ridge stainless front bumper will give you protection and style. The powder coated black Euro-Guard gives you that classic, black look.



11510.01 Euro Style Brush/Grille Guard

Euro Style Brush & Grille Guards **Gloss Black**

87-06 Wrangler, Each 11510.01



11511.02 Front Bumper Guard without Brush Guard

Front Bumper/Brush Guards

Add a bold rugged look to your vehicle with the Rugged Ridge Front Bumper Guard. Designed to bolt onto your existing factory bumper, the Front Guard bolts on in minutes with no drilling necessary. Made of 3/8" steel side plates and 2.5" tubular cross members with a black powder coat for enhanced appearance and protection from the elements. Add-on extra protection with the optional bolt on Brush Guard (Note: The Rugged Ridge Bumper Guard is required to install the Rugged Ridge Brush Guard).

Front Bumper and Brush Guards		Textured Black	Gloss Black
97-06 Wrangler (1)	Front Bumper Guard (A)	11511.01	11511.02
87-95 Wrangler (2)	Front Bumper Guard (A)	11511.03	-
97-06 Wrangler (1) (3)	Brush Guard (B)	11512.01	11512.02
87-95 Wrangler	Brush Guard (B)	11512.03	11512.04

(1) including Wrangler Unlimited (2) fits 11512.03 & 11512.04 (3) fits 11511.01 & 11511.02

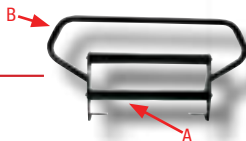

11511.02 Front Bumper Guard with 11512.02 Brush Guard

Frame Covers



11120.03 Front Frame Cover



Frame Covers

Stainless Steel

76-86 CJ, Front, Each	11120.01
87-95 Wrangler, Front, Each	11120.02
97-06 Wrangler/Unlimited, Front, Each	11120.03
76-86 CJ, Rear, Each	11120.04
97-06 Wrangler/Unlimited, Rear, Each	11120.05

The Defender Bumper

Big, burly and beautiful, this double tube front bumper gives you a look like no other. When that shiny over-built look is what you are going for, the Defender meets the criteria. Constructed of polished 304 stainless steel for rust free performance.



11521.01 defender bumper

Front Defender Bumper

Stainless Steel

55-06 CJ / Wrangler/Unlimited, Each 11521.01

Stainless Front and Rear Bumper Treatments



11107.06 Rear Bumper, Stainless

Want that classic look but with an extra "shine"? Rugged Ridge prime 304 Stainless front and rear bumpers offer a beautiful alternative to the classic replacement bumper. Add the ultimate touch with a set of polished stainless Rocker Guards. Designed to match and complement all Rugged Ridge polished stainless accessories, these bumpers will give your Jeep® that first class look while providing years of rust free service.



11107.05 Front Bumper without Holes, Stainless

Dress up the front of your vehicle with this simple to install bumper overlay. This overlay installs over your stock bumper to give a flashy look without the hassle of removing your bumper.

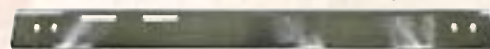

11109.02 Front Bumper Overlay, 87-95 Wrangler

Front & Rear Bumper Treatments, Stainless Steel		Part #
55-86 CJ	Front Bumper with Holes Each	11107.01
87-95 Wrangler	Front Bumper with Holes Each	11107.02
55-86 CJ	Front Bumper without Holes Each	11107.03
87-95 Wrangler	Front Bumper without Holes Each	11107.04
97-06 Wrangler*	Front Bumper without Holes Each	11107.05
97-06 Wrangler*	Rear Bumper without Holes Each	11107.06
87-95 Wrangler	Front Bumper Overlay Each	11109.02
76-86 CJ	Front Bumper Overlay Each	11109.01

* including Wrangler Unlimited

Side Tube Steps

07-10 WRANGLER MODELS HAVE 3 TUBE STEP SIZES TO CHOOSE FROM:

Complete the look with a set of Rugged Ridge tubular tough duty side steps. Available in 3" round, 4" round, and 4.25" oval diameter sizes. The large 4.25" oval and 4" round tubes provide a much cleaner look and are not "dwarfed" by oversized tires and oversized body style features of the 2007-10 Wrangler. Rugged Ridge Stainless Tube Steps feature prime 304L, .05" wall stainless tubing polished to a mirror finish. The polishing process for a Rugged Ridge step is longer and deeper pulling out the deepest shine from the steel. A true "deep polish"! Rugged Ridge painted steel Tube Steps feature special E-coated, .07" wall steel that is "thick source" powder coated for a tough chip resistant finish. The special E-coat undercoating provides double rust protection as it bonds to the metal creating a protective layer found nowhere else. All Rugged Ridge Tube steps feature a truly custom fit with installation brackets constructed of durable 3/16" powder coated steel for long life and years of flex-free use. Each Tube Step features special UV treated no-slip step pads with 5 mounting pins. These step pads are preinstalled on top of the tube - no exposed metal to rust. All 2007-10 Wrangler models are no drill designs. 1976-06 models feature frame mount design which may require drilling.

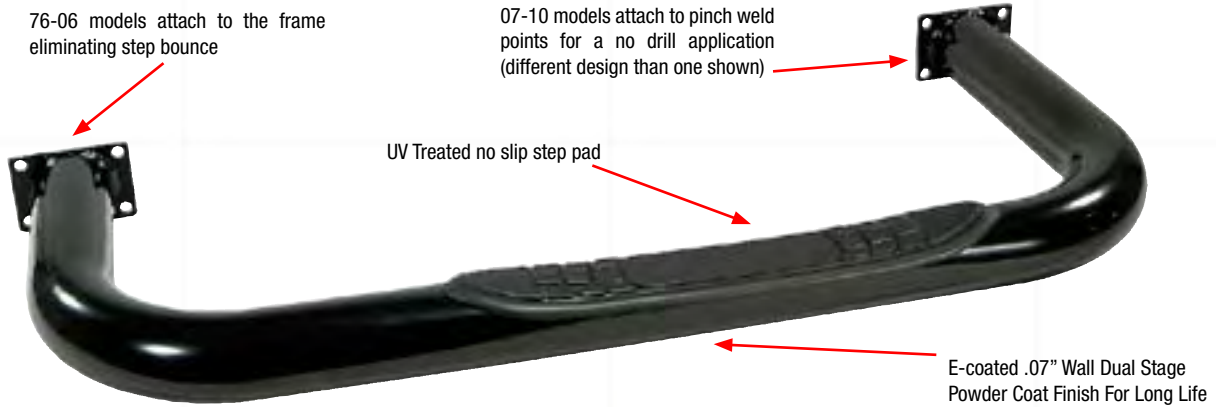
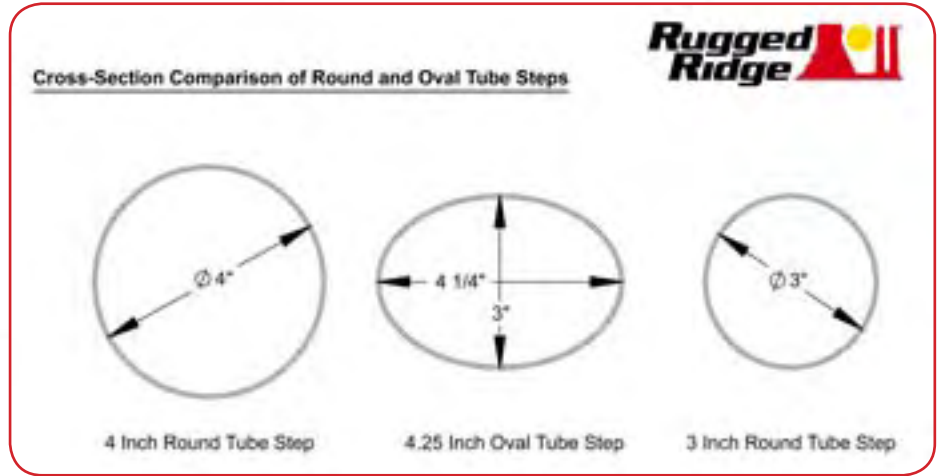

Whether you want to dress it up flashy or keep it subtle, Rugged Ridge has a tube step style just for you. Why settle for only one tube style when Rugged Ridge offers so much more?

JK



11591.06 3" Round Tube Step, Textured Black, 07-10 4-Door Wrangler

Choose the step that fits *YOUR* style.



11593.10 4" Round Tube Step, Stainless, 07-10 4-Door Wrangler



11593.07 4 1/4" Oval Tube Step, Stainless, 07-10 2-Door Wrangler



3" Round Tube Step, Black

3" Round Tube Step, Textured Black

3" Round Tube Step, Stainless Steel

4" Oval Tube Step, Textured Black

4" Oval Tube Step, Stainless Steel

4" Round Tube Step, Stainless Steel



11590.06 3" Round Tube Steps, Black, 07-10 4-Door Wrangler



Side Tube Steps	Black	Textured Black	Titanium	Stainless
07-10 Wrangler 3" Round, 2-Door Pair	11590.05	11591.05	-	11593.05
07-10 Wrangler 3" Round, 4-Door Pair	11590.06	11591.06	-	11593.06
07-10 Wrangler 4" Round, 2-Door Pair	-	-	-	11593.09
07-10 Wrangler 4" Round, 4-Door Pair	-	-	-	11593.10
07-10 Wrangler 4 1/4" Oval, 2-Door Pair	-	11591.07	-	11593.07
07-10 Wrangler 4 1/4" Oval, 4-Door Pair	-	11591.08	-	11593.08
97-06 Wrangler 3" Round Pair	11590.04	11591.04	11592.04	11593.04
87-95 Wrangler 3" Round Pair	11590.03	11591.03	11592.03	11593.03
76-86 CJ7 3" Round Pair	11590.02	11591.02	11592.02	11593.02
76-83 CJ5 3" Round Pair	11590.01	-	-	-
84-01 Cherokee 3" Round, 4-Door* Pair	11590.81	-	-	-
99-04 Grand Cherokee 3" Round Pair (NEW)	-	-	-	81593.32
05-10 Grand Cherokee 3" Round Pair (NEW)	-	-	-	81593.33

*Tube Step has 2 Step Pads per side, will also fit 2-Door Cherokee

All-Terrain Flat Fender Flares

Now, with the NEW All-Terrain Flat Fender Flares from Rugged Ridge you can add a bigger tire option for a true off road look. You can also use in combination with a suspension lift for maximum off road performance. These exciting new flares are out-of-the-box ready to turn your street Jeep into an off road machine. By removing your original flares and replacing them with these high clearance designs, you can run larger tires without interference from the flare. The ability to run a larger tire with little or no suspension lift means a "lower center of gravity" making your JK more stable, yet you still get greater ground clearance necessary for off road. With 1.5 inches less coverage in the front and 1 inch less in the rear these flares are slightly narrower than factory, yet still maintain proper tire coverage and aggressive looks. Constructed of a flexible UV treated high impact thermoplastic, these flares are designed for the trail and create a whole new look for your JK. Easy to install, these flares replace your factory flares, attaching to the factory mounting points with no drilling. Simply remove your original flares and add on the All Terrain flares. The kit also includes easy to install mounting brackets that allow you to relocate and use the existing factory side marker lights. The All Terrain Flat Fender Flare is the hottest looking, most functional Off Road Flare available for your JK! Finally, because no cutting or drilling is required, if you ever want to switch back to your original factory flares, there's no problem!

JK



Special side marker light brackets included for use with your factory side marker light

All Terrain Flat Fender Flare Kit

Part

Flat Fender Flare Kit, 2007-10 Wrangler 2 and 4-Door, 4 Pcs. (NEW) 11620.10

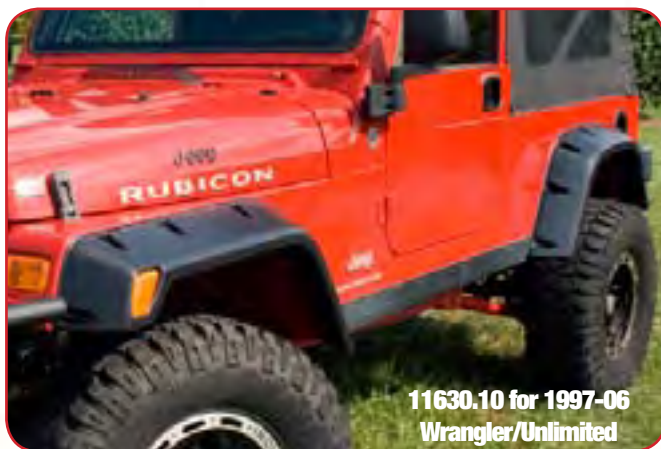

11630.10 for 1997-06
Wrangler/Unlimited

All Terrain Fender Flares

Get that aggressive off road look with the NEW Rugged Ridge All Terrain Fender Flare! These 6" flares feature a stylish design while protecting your vehicles paint from flying rocks and mud. Constructed of durable UV treated ABS with a slight texture, these paintable flares provide a great look while being able to handle whatever nature throws at them. Each All Terrain Flare is designed to fit factory mounting points (CJ and YJ designs require some drilling) with durable rust proof stainless fasteners. Each front flare uses your existing side marker lights by easily attaching to custom light cut-outs. Backed by an industry leading 3 year limited warranty, these NEW All Terrain Flares will really set you apart from the crowd!



11632.10 for 1987-95
Wrangler

NEW!

Custom designed for use with the factory side marker light

Special styling gives these flares that aggressive off road look



Stainless fasteners provide a great look and ease of installation

UV enhanced ABS design for long life and a great look

All Terrain Fender Flare Kits

Part

Fender Flare Kit w/ Hardware, 1997-2006 Wrangler/Wrangler Unlimited, 6 Pc. Kit (NEW) 11630.10

Fender Flare Kit w/ Hardware, 1987-95 Wrangler*, 6 Pc. Kit (NEW) 11632.10

Fender Flare Kit w/ Hardware, 1976-83 CJ5, 1976-86 CJ7, 1981-86 CJ8*, 6 Pc. Kit (NEW) 11633.10

* Some drilling required.

Oversized 7" Flares



Need a little extra coverage for those over-sized tires? The Rugged Ridge 7" Flare gives you the extra coverage you need while providing the clean look of original equipment designs. Each over sized Flare is constructed of virtually indestructible UV treated thermoplastic to provide years of service. The special UV treatment put on each flare provides protection from sun fading. These Flares are designed to bolt onto your vehicle but for CJ and 1987-95 Wrangler models some vehicle modification may be necessary to truly cover those oversized tires. If you go off-road and need to protect your vehicle from rock chips and debris, look to Rugged Ridge 7" oversized Fender Flares! Includes all mounting hardware.



Oversized 7" Fender Flares

Part

76-86 CJ7, 4 Piece Kit w/all mounting hardware *	11606.01
87-95 Wrangler, 6 Piece Kit w/all mounting hardware *	11607.01
97-06 Wrangler, 6 Piece Kit w/all mounting hardware	11608.01

* some trimming of the rear wheel well area is required to install oversized flares on CJ & YJ

11608.01 Oversized 7" Flares, 97-06 Wrangler



11607.01 Oversized 7" Flares, 87-95 Wrangler



11606.01 Oversized 7" Flares, 76-86 CJ



Replacement Fender Flare Kits

Rugged Ridge provides the most comprehensive replacement Fender Flare program on the market today. Covering model years starting in 1955 until current, Rugged Ridge has you covered when it is time to replace or upgrade your Factory Fender Flares. Each Flare is constructed of virtually indestructible, durable, UV treated thermoplastic to provide years of service. Each replacement flare is designed to fit into your factory mounting holes (some models may require some hole relocation) for ease of installation. Just need to replace one flare? No problem. Rugged Ridge offers individual replacements to keep your investment to a minimum.



11603.01 Replacement Fender Flare Kit, 97-06 Wrangler TJ



11602.01 Replacement Fender Flare Kit, 87-95 Wrangler YJ



11601.01 Replacement Fender Flare Kit, 55-86 Jeep® CJ



11605.01 Replacement Fender Flare Kit, 84-96 Cherokee XJ



11601.01 Replacement Fender Flares, 55-86 Jeep® CJ

	Complete Kit	Part #	Front Passenger	Part #	Front Driver	Part #	Rear Passenger	Part #	Rear Driver	Part #
07-10 Wrangler* (NEW)	4-pc kit w/out hardware	11609.01	Each	11609.10	Each	11609.11	Each	11609.12	Each	11609.13
97-06 Wrangler	6-pc kit w hardware	11603.01	Each	11603.04	Each	11603.03	Each	11603.06	Each	11603.05
	4-pc kit w/out hardware	11603.02								
87-95 Wrangler**	6-pc kit w hardware	11602.01	Each	11602.04	Each	11602.03	Each	11602.06	Each	11602.05
	4-pc kit w hardware	11602.02								
55-86 CJ5/CJ7	4-pc kit w hardware	11601.01	Each	11601.02	Each	11601.03	Each	11601.04	Each	11601.05
81-86 CJ8 Scrambler	4-pc kit w hardware	11604.01	Each	11601.02	Each	11601.03	Each	11604.02	Each	11604.03
84-96 Jeep Cherokee	4-pc kit w/out hardware	11605.01	Each	11605.02	Each	11605.03	Each	11605.05	Each	11605.04

*Except Sahara Models. **Does not fit YJ Renegade models.

<p>11602.07, 11602.08 Flare Extensions</p>	<p>11602.09 Extension Retainer</p>	<p>11601.06 Hardware Kit</p> <p>Screws Included</p>	<p>11603.07, 11603.08 Flare Extensions</p>
<p>11603.09 Hardware Kit</p>			

Replacement Fender Flare Hardware & Extensions

Application	Item/Feature	Part #
87-95 Wrangler	Flare Extension, Driver Side Each	11602.07
87-95 Wrangler	Flare Extension, Passenger Side Each	11602.08
87-95 Wrangler	Extension retainer Each	11602.09
55-86 CJ	Hardware Kit (Extension retainer not included)	11601.06
97-06 Wrangler	Flare Extension, Driver Side Each	11603.07
97-06 Wrangler	Flare Extension, Passenger Side Each	11603.08
97-06 Wrangler	Hardware Kit	11603.09



11602.05 Rear Flare, Driver Side, 87-95 Wrangler

Wheels For 2007-10 Wrangler



15301.10 Satin Black with Machined Lip

15301.01 Satin Black

15301.40 Silver

15301.20 Chrome



LIMITED EDITION



15301.50 Hyper Silver, 17"x9"
*while supplies last

Rugged Ridge is proud to introduce the toughest new design in custom wheels for 2007-10 Wrangler. This Hub-Centric design exactly centers the wheel over the hub providing proper balance, clearance for brake rotors, steering components and suspension. Better fit, no wheel vibration! Stainless steel button-head socket cap screws around the perimeter of the outer wheel face give a great 3-piece look, and also let you accessorize with our optional

trim ring. Each wheel includes a UV-treated polished center cap that replicates a manual hub for that off road look. Available in five finishes: Satin Black Powdercoated, Satin Black Powdercoated with Machined Lip, Silver Powdercoated, Dual-Stage Polished Chrome, and Limited Edition Hyper Silver. The durable powdercoated finish gives an ultra-hard finish for long life and a great look. The chrome finish uses a dual-stage process to give a deep reflective mirror-like shine that commands attention. Rugged Ridge wheels have been independently tested and certified to meet/exceed SAE J2530 standards for wheel strength and durability. Limited lifetime structural warranty and 1 year finish warranty (see warranty information for details and limitations).

Rugged Ridge Wheels for 07-10 Wrangler	Part #
Rugged Ridge Wheel, 17"x9", 12mm Offset, Satin Black	15301.01
Rugged Ridge Wheel, 17"x9", 12mm Offset, Satin Black w/Machined Lip	15301.10
Rugged Ridge Wheel, 17"x9", 12mm Offset, Silver	15301.40
Rugged Ridge Wheel, 17"x9", 12mm Offset, Chrome	15301.20

JK

COMING SOON!

NEW!

Steel D-Window Wheels

Legendary looks, brutally epic strength. Each Rugged Ridge steel wheel is stamped from heavy gauge steel and powder coated with a durable black finish. Our wheels have been engineered, tested and certified to meet and exceed the strenuous SAE J2530 standards for wheel strength and durability. Turning a million cycles at double their load capacity to ensure they could hold up to abuses of off road use. Because a Jeep isn't a Jeep until its lifted and outfitted with oversized tires. (Expected Spring 2010.)



Description	Part #
Steel wheel D-Window, Black, 15X8, 5 on 4.5 bolt pattern, 3.75 backspacing, Jeep Wrangler (YJ) 87-95, (TJ) 97-06, Cherokee (XJ) 84-01 (NEW)	15500.01
Steel wheel D-Window, Black, 15X10, 5 on 4.5 bolt pattern, 3.75 backspacing, Jeep Wrangler (YJ) 87-95, (TJ) 97-06, Cherokee (XJ) 84-01 (NEW)	15500.02
Steel wheel D-Window, Black, 15X8, 5 on 5.5 bolt pattern, 3.75 backspacing, Jeep CJ 46-86 (NEW)	15500.10



15250.02 Rim Protector
Satin Black for 17"x9" Wheel

Rim Protectors

Trim rings are available in either Satin Black Powdercoated or Polished Stainless Steel. These trim rings are a great way to protect the wheel lip and tire bead. They also allow you to change the look of your wheels with just a few bolts. For use with Rugged Ridge wheels only.



15250.01 Rim Protector
Polished Stainless Steel for 17"x9" Wheel

Rugged Ridge Rim Protectors for Rugged Ridge Wheels Only	Part #
Rugged Ridge Rim Protector, 17"x9", Polished Stainless Steel *	15250.01
Rugged Ridge Rim Protector, 17"x9", Satin Black *	15250.02

* Will not fit 15301.20 Wheel back spacing = 4.625"

Wheel Spacer & Adaptor Kits



15201.02 Wheel Spacer, pair, 1987-06 Wrangler with 5 on 4.5" Bolt Pattern



15201.03 Wheel Spacer, pair, 1945-86 Jeep® with 5 on 5.5" Bolt Pattern



15201.04 Wheel Adapter, pair, for Converting Bolt Pattern 5 on 4.5" to 5 on 5.5"



15201.05 Wheel Spacer, pair, 2007-10 Wrangler with 5x5" Bolt Pattern

These hub centric spacers / adapters move your wheels out to help fit wider tires and give your vehicle a wider track and improve stability. Constructed of double anodized black extra thick 6061T6 aluminum for long life and extra corrosion resistance. All hardware is grade-8 for extra strength. Each part number comes as a spacer pair. Included are 10 pre-installed grade-8 wheel studs, 10 lug nuts and thread locker.

See page 91 for UTV Wheel Spacers

CAUTION!
CAUTION: Rugged Ridge™ recommends use of wheel spacers with all suspension lifts to reduce risk of roll over or other accident associated with modifying ride height for increased off road capabilities. See additional product safety information and WARNINGS at back of catalog.

Wheel Spacer Kit		Part #
07-10 Wrangler, Pair	1.5" Spacer	15201.05
07-10 Wrangler, Pair *	1.375" Adapter	15201.06
07-10 Wrangler, Pair **	1.375" Adapter	15201.07
87-06 Wrangler, 84-01 Cherokee, Pair	1.25" Spacer	15201.02
87-06 Wrangler, Pair (NEW)	1.5" Spacer	15201.08
45-86 Wrangler, Pair (NEW)	1.5" Spacer	15201.09
45-86 CJ, Pair	1.25" Spacer	15201.03
87-06 Wrangler, Pair ***	1.25" Adapter	15201.04

* converting 5 on 5" to 5 on 4.5" bolt pattern
** converting 5 on 5" to 5 on 5.5" bolt pattern
*** converting 5 on 4.5" to 5 on 5.5" bolt pattern

Water Resistant Cab/Full Covers

Custom fit Cab Covers protect your vehicles interior from dust, dirt and light showers. Constructed of vinyl coated polyester fabric or a space age cover material (Weather Lite/Three Layer Covers), these easy to use covers install in minutes. Reinforced elastic side straps and under body hooks hold the cab cover in place. No drilling required. Complete vehicle covers also available in breathable Weather Lite fabric or durable Three Layer Fabric. Weather Lite is perfect for inside storage while the Three Layer covers are designed for short term outdoor use.

JK



Complete Cover kits with lock and storage bag available.

Full Covers

Part

Three Layer Full Car Cover (w/Bag & Lock) 07-10 4-Door Wrangler	13321.73
Three Layer Full Car Cover (Cover only) 07-10 4-Door Wrangler	13321.71
Three Layer Full Car Cover (w/Bag & Lock), 07-10 2-Door Wrangler	13321.81
Three Layer Full Car Cover (Cover only), 07-10 2-Door Wrangler	13321.80
Three Layer Full Car Cover (w/Bag & Lock), 03-06 Wrangler Unlimited	13321.73
Three Layer Full Car Cover (Cover only), 03-06 Wrangler Unlimited	13321.71
Three Layer Full Car Cover, 55-06 CJ/Wrangler ¹	13321.70
Weather Lite Full Cover, All CJ7 & Wrangler ¹	13321.51
Three Layer Full Car Cover (w/Bag & Lock), 55-06 CJ & Wrangler	13321.72
Car Cover Storage Bag	12105.01

¹ Will not fit 03-06 Unlimited

3 LAYER PROTECTION!

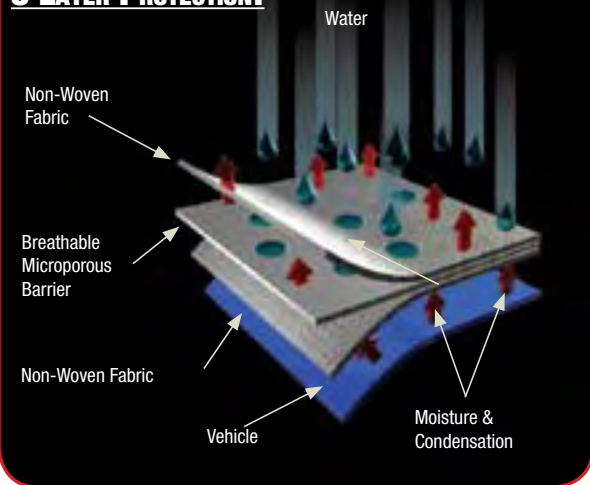

Cab Covers

Part

Water Resistant Vinyl Cab Cover, 92-06 Wrangler, Spice (2)	13316.37
Water Resistant Vinyl Cab Cover, 92-06 Wrangler, Grey (2)	13316.09
Water Resistant Vinyl Cab Cover, 87-91 Wrangler, Grey	13310.09
Water Resistant Vinyl Cab Cover, 76-86 CJ7, Grey	13315.09
Three Layer Cab Cover, 76-06 CJ & Wrangler (2)	13321.02
Weather Lite Cab Cover, 76-06 CJ & Wrangler (2)	13321.01

(2) will not fit 03-06 Unlimited

Hard Top Sound Deadener/Insulation For 2007-10 Wrangler

If you chose the Hard Top option for your 07-10 Wrangler then you need Rugged Ridge's Sound Deadener. This insulation is custom fit for the factory multi-piece hard top and greatly reduces noise inside your vehicle. The special insulation material is surrounded by heavy duty pleated nylon providing added interior comfort by insulating the cab from heat and cold. A no drill installation with durable hook and loop fasteners allows for an easy installation without removing your hard top.

JK



Sound Deadener for 07-10 Wrangler Hard Top Part

07-10 Wrangler 2-Door, 3 pcs. (NEW)	12109.01
07-10 Wrangler 4-Door, 4 pcs. (NEW)	12109.02

JK Soft Top Storage Boot

Want to cruise around with the top off, but keep your top close in case of sudden showers or temperature drops? The Rugged Ridge Soft Top Storage Boot is the solution to protect your soft top when it is folded down. Designed to be used with the windows zipped out. (See page 31, 12106.01 for window storage bag solutions.)

Description	Part #
Soft top storage boot, Black Diamond, Jeep Wrangler (JK) 2-Door 07-10, Each (NEW)	12104.50
Soft top storage boot, Black Diamond, Jeep Wrangler (JK) 4-Door 07-10, Each (NEW)	12104.51

NEW!



JK

Rugged Ridge

Rugged Ridge Summer Accessories

Summer time is why you own a Jeep®! With the warm weather comes the open air driving we all love. Rugged Ridge Summer Accessories make that open air driving more comfortable and stylish. Each accessory is manufactured to exacting specifications using tough matching vinyl coated fabrics that will provide years of great looks and high performance. When you demand the best, Rugged Ridge is what you need! **Early model and UTV Summer Brief applications available too! See page 116 for UTV.**

Summer Briefs

Custom designed for each body style, these easy on, easy off briefs provide protection from the hot sun and sudden showers. Each Rugged Ridge Summer Brief attaches to the factory center hoop and windshield with heavy-duty nylon straps to prevent flapping. Key rear strap attachments have quick release fasteners so once your straps are set, they easily detach and reattach. Wrangler models also incorporate thick hook and loop side mounts to further secure the top. All 1997-10 models are designed to be used with a no-drill Windshield Header (sold separately, see bottom of page) for quick conversion from hard top to Summer Brief.



Pocket Brief shown on 2008 Wrangler



	Black	Grey	Denim Black	Spice	Diamond Black	Diamond Khaki
Summer Brief, 07-10 Wrangler, 2-Door ^{1,4}	-	-	-	-	13587.35	13587.36
Header Summer Brief, 97-06 Wrangler ² , Unlimited ²	-	-	13580.15	13580.37	13580.35	13580.36
Summer Brief, 92-95 Wrangler ³	-	13574.09	13574.15	13574.37	-	-
Summer Brief, 87-91 Wrangler ³	13573.01	13573.09	13573.15	-	-	-
Summer Brief, 76-86 CJ7 ³	13572.01	-	-	-	-	-
Summer Brief, 76-83 CJ5 ³	13571.01	-	-	-	-	-
Summer Brief, 55-75 M38A1 & CJ5	13570.01	-	-	-	-	-

¹ Requires separate Windshield Header (#13308.05) for installation. ² Requires separate Windshield Header (#13308.04) for installation. ³ Requires separate Windshield Channel (#13308.01) for installation. ⁴ Includes Pockets.

Windshield Channels/Headers

These upgraded preassembled windshield headers installs quickly and easily! Just attach your Brief/Island Topper and place the header channel on the top of your windshield, slide the clamps onto the supplied knobs and clamp the channel in place. That's it! The channel is now securely held in place and ready for summer wheeling. No drilling or modifications required! Note: Will work with Bestop and other aftermarket summer tops. No Drill Windshield Header required for installation of Summer Briefs and Island Toppers on all 1997-10 Wranglers and Unlimited. Windshield Channels are required for installation of Summer Briefs and Island Toppers on all 1976-95 CJ/Wranglers.



13308.01 Windshield Channel for 76-95 CJ/Wrangler



13308.04 Windshield Header for 97-06 Wrangler



13308.05 Windshield Header for 07-10 Wrangler

Easy, No Drill Design. Simple One Minute Assembly!

Header Attaches with Only 2 Knobs



NOTE: If your 76-95 Jeep® already has a Windshield Channel installed on it, we highly recommend replacing it. Over time, these channels can come loose and will no longer hold your Summer Brief/Roll Bar Top in place.

Pocket Briefs

Tired of papers and other small items flying around the cab of your Jeep® when using your Summer Brief? Introducing the most innovative new addition to a Summer Brief in over 50 years the Pocket Brief from Rugged Ridge! This revolutionary design incorporates two mesh zippered corner pockets directly over the driver and passenger creating much needed storage space. Special two sided mesh and nylon “pocket” seals shut with a reinforced zipper, keeps small items secure even in most severe conditions. Built directly into the Rugged Ridge Summer Brief to ensure a clean, tight fit. Constructed of durable soft top fabric for long life. Available in matching soft top colors to give your Jeep® a finished look.



JK

Pocket Brief	Grey	Denim Black	Spice	Diamond Black	Diamond Khaki
07-10 Wrangler, 2-Door*	-	-	-	13587.35	13587.36
97-06 Wrangler, Unlimited**	-	13585.15	13585.37	13585.35	13585.36
92-95 Wrangler***	13584.09	13584.15	13584.37	-	-
87-91 Wrangler***	-	918315	-	-	-

* Requires a separate Windshield Header (#13308.05) for installation ** Requires a separate Windshield Header (#13308.04) for installation *** Requires a separate Windshield Channel (#13308.01) for installation

Mesh Summer Briefs/Island Toppers™

Special UV treated mesh fabric blocks the heat while allowing the cool breeze to flow through. The special weave of the Rugged Ridge mesh brief/Island Topper is designed for strength and durability while providing open air protection from the sun's heat. Available in two great styles: the Summer Brief that goes to the center hoop and the “Island Topper” Island Topper that goes back to cover those rear seat passengers. Don't forget the Header/Windshield channel needed to install these tops!

Sun Stop Mesh “Island Topper” Island Topper



Sun Stop Mesh Summer Brief



	Part #
Mesh Summer Brief, 07-10 Wrangler 2-Door, Each *	13579.02
Mesh Summer Island Topper, 07-10 Wrangler 2-Door, Each *	13579.01
Mesh Summer Island Topper, 07-10 Wrangler 4-Door, Each *	13579.03
Mesh Summer Brief, 97-06 Wrangler, Unlimited, Each **	13576.01
Mesh Island Topper, 97-06 Wrangler, Each **	13578.01
Mesh Summer Brief, 92-95 Wrangler, Each ***	13575.01
Mesh Island Topper, 92-95 Wrangler, Each ***	13577.01

* Requires a separate Windshield Header (#13308.05) for installation
 ** Requires a separate Windshield Header (#13308.04) for installation
 *** Requires a separate Windshield Channel (#13308.01) for installation

Island Toppers™

Provide the ultimate summer sun and rain protection with a Rugged Ridge Island Topper. Attaching the same way as our durable Summer Briefs, these full length tops provide protection from the elements for both the front and rear passengers. Rear attachment straps attach to the rear sport bar hoops on 1992-10 models. 1976-91 models include an easy to attach rear bow. All 1997-10 models are designed to be used with an optional, no-drill Windshield Header for quick conversion from hard top to Summer Brief.



13581.35 Island Topper, Diamond Black, 97-06 Wrangler



13581.36 Roll Bar Top, Diamond Khaki, 97-06 Wrangler

	Grey	Denim Black	Spice	Diamond Black	Diamond Khaki
Header Island Topper, 97-06 Wrangler*	-	13581.15	13581.37	13581.35	13581.36
Island Topper, 92-95 Wrangler**	13553.09	13553.15	13553.37	-	-
Island Topper, 76-91 CJ & Wrangler**	13554.09	13554.15	-	-	-

* Requires a separate Windshield Header (#13308.04) for installation

** Requires a separate Windshield Channel (#13308.01) for installation

Pocket Island Toppers™



Pocket Island Toppers feature zippered pockets to securely stow away important items like cell phones, maps and sunglasses.



Pocket Island Toppers for 07-10 Wranglers feature a rear zippered pocket for even more secure storage.



13588.35 Island Topper, Diamond Black, 07-10 Wrangler

The most advanced summer soft top solution found on the market today, the new Pocket Island Topper! This new design features tough diamond fabric combined with a pair of zipper front pockets (and one large rear pocket on 2007-10 Wrangler) for the ultimate full featured top. Unlike other summer tops on the market, the Rugged Ridge design features wider side hook and loop fastener straps, a reinforced front section and extra heavy duty nylon tie down straps.

Pocket Island Toppers	Diamond Black	Diamond Khaki
07-10 Wrangler, 2-Door*	13588.35	13588.36
07-10 Wrangler, 4-Door*	13589.35	13589.36
97-06 Wrangler**	13586.35	13586.36

* Requires a separate Windshield Header (#13308.05) for installation

** Requires a separate Windshield Header (#13308.04) for installation



Acoustic Brief and Island Topper™

This unique design drastically reduces road noise within the cab of your Jeep®. We have lined each Acoustic piece with a tightly woven, padded acoustic insert that absorbs outdoor noise to allow for a pleasant driving experience. You can finally listen to your favorite radio or CD while you enjoy open air driving! Durable quick release buckles for easy on - easy off installation. Acoustic Brief provides overhead protection for both front seat passengers. Acoustic Island Topper provides overhead protection for both front & rear passengers.



Padded insert absorbs noise allowing for a more pleasant driving experience

Acoustic Island Topper, Header Mount, Black Denim Part

97-06 Wrangler, Each * 13582.15

Acoustic Brief, Header Mount, Black Denim

97-06 Wrangler/Unlimited, Each * 13583.15

* Requires a separate Windshield Header (#13308.04) for installation

Roll Bar Curtain

Provides protection from dust, rain and other debris from entering the cab of your Jeep® and also keeps heat in during the cold winter months. Easily attaches to the sport bar with durable nylon straps. Constructed of durable soft top fabric that matches other Rugged Ridge Accessories. Special rear opening allows for easy access to cargo area: zips open and closed. DOT approved rear glass allows for rear visibility.



Roll Bar Curtain, 80-06 CJ, Wrangler & Unlimited

Grey	Denim Black	Spice	Diamond Black	Diamond Khaki
13552.09	13552.15	13552.37	13552.35	13552.36

Roll Bar Cover Kits

Custom covers dress up your vehicle's roll bar with light weight foam and summer soft goods fabric. Roll Bar Covers easily install using zippers and "hook & loop" attachments. Special cut outs for seat belt locations make the covers look clean. Multiple piece design available for 1992-02 Wrangler models with over the door cross members.



Roll Bar Cover Kits	Part #
97-02 Wrangler, Denim Black, 3 pc. Kit	13612.15
92-95 Wrangler, Denim Black, 3 pc. Kit	13611.15
78-91 CJ & Wrangler, Denim Black, 1 pc. Main Hoop Cover *	13610.15
78-91 CJ & Wrangler, Black, 1 pc. Main Hoop Cover *	13610.01
* 87-91 Wrangler, does not include spreader cover	

Tire Covers

Custom designed to fit today's most popular sized tires. Constructed of durable vinyl coated polyester fabric. Colors match other Rugged Ridge Soft Accessories. Please measure tire diameter.

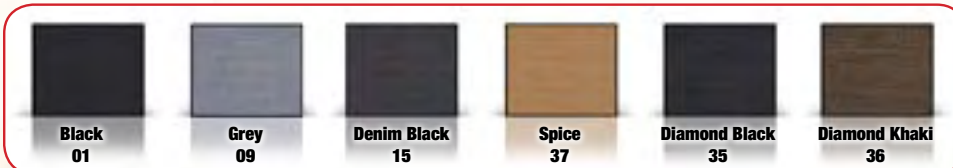

Tire Diameter	Black	Grey	Denim Black	Spice	Diamond Black	Diamond Khaki
27-29"	12801.01	12801.09	12801.15	12801.37	12801.35	12801.36
30-32"	12802.01	12802.09	12802.15	12802.37	12802.35	12802.36
33"	-	12803.09	12803.15	-	12803.35	-
35-36"	-	12804.09	12804.15	-	12804.35	-

Note: To ensure proper fit, measure the diameter of the tire you are covering and pick the appropriate tire cover size listed above.

Quality, Value, Selection, XHD Replacement Tops have you covered!

New and improved XHD Replacement Soft-Tops from Rugged Ridge are now available with 50% thicker glass! Each Fabric Soft Top is specifically designed to easily fit the factory original soft top hardware. Simply take off the old top and slip on the new. It's just that easy! These new designs feature reinforced stitching on the heavy "pull" areas as well as heavy duty 30 mil thick glass! All XHD Soft Tops feature durable vinyl coated polyester and cotton fabric that will last the test of time. All sewn seams use marine grade thread to make sure it does not deteriorate or discolor in the sun. Each seam is literally "welded shut" with durable heat seal tape to keep moisture out while keeping the original look of the top intact. Attaching the Rugged Ridge Top is easy with the factory original "belt rail" attachment method; simply tuck under the rail and go! All our tops feature two choices of door options as Jeep® offered the 97-06 Wrangler with upper soft doors or with full hard doors. Rugged Ridge makes a Replacement Top that fits either! Each top is backed by an industry leading [3 year limited warranty](#) against manufacturer defects.

The most comprehensive line of replacement soft tops on the market, so you can choose what options are best for you!

13727.35 Fabric Replacement Top with Upper Doors for 03-06 Wrangler

13729.35 Fabric Replacement Top (no upper doors) for 03-06 Wrangler



Zip-Out Windows

Get that safari look with the easily removable side and rear windows zipped out on Jeep® models! Rugged Ridge also offers a handy Window Storage Bag to protect those windows from damage. See page 31.

The Best Materials

All Rugged Ridge Soft Tops feature durable vinyl coated polyester and cotton fabric with "welded shut" seams that use durable heat seal tape to keep moisture out! These tops are real weather beaters and carry a *3 year limited warranty*.

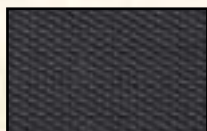

Diamond Fabric now available

NEW 30 mil thick DOT approved windows are 50% thicker than lower cost soft tops! Each is UV treated for long life and ultimate clarity!

Tinted Window Models Available



With Rugged Ridge you do not have to pay a fortune for 31% tinted window option! Each window has been up-graded to 30 mil which is 50% thicker than other soft top brands! Rugged Ridge tinted windows last longer and keep the heat out! (Door windows not tinted).



50% THICKER GLASS!



53703.15 Fabric Replacement Soft Top

53701.52 Fabric Replacement Soft Top

Need a Replacement Top for your Suzuki®/Geo Tracker?

Only Rugged Ridge can offer you a full line of replacement soft tops for the 1988-98 Suzuki and Geo Tracker vehicles! Our value priced soft tops will freshen up the look of your vehicle while not "breaking the bank". Each top is constructed of durable vinyl coated polyester soft top fabric with DOT approved, UV treated, crystal clear 30 mil windows for long life and durability. Windows for Suzuki Samurai do not zip out. Rear windows for 1988-94 Sidekick/Geo Tracker zip out. Both rear and side windows for 1995-98 Sidekick/Geo Tracker zip out. Get your Rugged Ridge top today and make your Suzuki/Geo Tracker the talk of the town!



XHD Soft Top Applications

Fabric Replacement Tops for 88-95 Jeep® Wrangler	Charcoal	Black Denim	Spice
W/Door Skins, Each	13721.09	13721.15	13721.37
W/Door Skins, Tinted Windows, Each	13722.09	13722.15	13722.37
Fabric Replacement Tops for 97-02 Jeep® Wrangler	Black Denim	Dark Tan	Spice
W/Door Skins, Each	13723.15	13723.33	13723.37
W/Door Skins, Tinted Windows, Each	13724.15	13724.33	13724.37
No Door Skins, Each	13725.15	13725.33	13725.37
No Door Skins, Tinted Windows, Each	13726.15	13726.33	13726.37
Fabric Replacement Tops for 03-06 Jeep® Wrangler	Diamond Black	Diamond Khaki	
W/Door Skins, Each	13727.35	13727.36	-
W/Door Skins, Tinted Rear Windows, Each	13728.35	13728.36	-
No Door Skins, Each	13729.35	13729.36	-
No Door Skins, Tinted Rear Windows, Each	13730.35	13730.36	-
Fabric Replacement Tops for Suzuki®/Geo Tracker	Black Denim	White Denim	
Suzuki® Samurai, All Years (Rear & side windows do not zip out), Each	53721.15	53721.52	-
88-94 Suzuki® Sidekick/Geo Tracker (only rear windows zips out), Each	53722.15	53722.52	-
95-98 Suzuki® Sidekick/Geo Tracker (rear & side windows zip out), Each	53723.15	53723.52	-

WARNING: Warning: Tops and doors are designed only for protection against the elements. Do not rely on top or doors to contain occupants within the vehicle or protect against injury during an accident. Consult vendor's product safety literature for additional information and WEAR SEAT BELTS AT ALL TIMES.

XHD Replacement Soft Tops

Replacement Top Hardware for 87-95 YJ



Includes all the necessary components to completely replace/upgrade your factory original soft top hardware. Our exclusive OE quality tailgate bar provides an upgraded tailgate seal and easy installation. Adjustable Side Spreader Bars have been upgraded to ensure a long life. Combine with a fabric only XHD replacement top (see pages 28-29) for an inexpensive complete soft top.

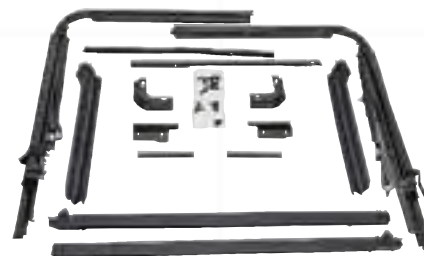

Replacement Hardware	Part #	Price
87-95 YJ Wrangler, Kit	13510.01	



Replacement Spreader Bars for 87-95 YJ

Upgrade or replace those worn original equipment YJ Spreader Bars. Deluxe Spreader Bars are upgrades from original and are sold individually. Ultimate Spreader Bars, sold in pairs, incorporate a twist soft top tightening feature that can tighten your soft top during warm weather.

Replacement Spreader Bars	Part #
Deluxe Spreader Bar, 87-95 YJ Wrangler, Each	11251.01
Ultimate Adjustable Spreader Bars, 87-95 YJ Wrangler, Pair	11251.02

Soft Top Windshield Retainer for 87-95 YJ

Replaces factory plastic retainers that are mounted vertically on the left and right side of the YJ windshield frame inside the vehicle. Available in pairs or individually.

	Part #
87-95 Wrangler, Drivers Side, Each	12306.03
87-95 Wrangler, Pass. Side, Each	12306.04
87-95 Wrangler, Pair	12306.05



Soft Top Disconnects



11251.04 Soft Top Disconnect for 07-10 Wrangler 4-Door

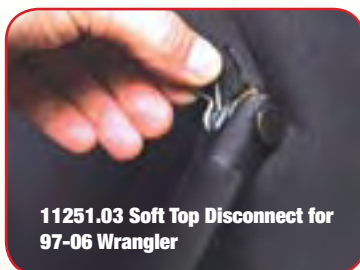

11251.03 Soft Top Disconnect for 97-06 Wrangler

Upgrade your factory 1997-06 or 2007-10 Wrangler Soft Top Hardware with these quick release bow mounts. Allows for easy, no tool disconnect of your soft top bows from your Jeep®. Installation is easy and quick, no drilling required.

Soft Top Disconnect Kit	Part #
07-10 Wrangler 4-Door, 4 pack	11251.04
97-06 Wrangler, 4 pack	11251.03

Replacement Tailgate Bar with Tonneau Cover



Tailgate Bar/Tonneau

Upgrade your rear tailgate bar with this high quality Tonneau/Tailgate Bar from Rugged Ridge. A special tailgate seal provides the ultimate attachment for your rear soft top window to the tailgate bar. As an added feature, a special channel has been added to attach the enclosed behind the seat tonneau cover to keep valuables out of sight.

Replacement Tailgate Bar w/Black Denim Tonneau	Part
87-06 Wrangler, Each	13550.01

Replacement Soft Top Upper Door Frames

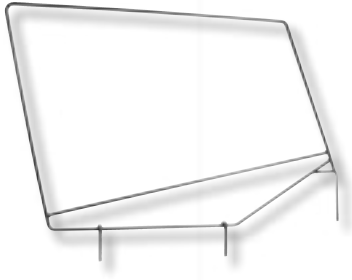

**13701.80 Door Frame,
87-95 Wrangler**



**13703.80 Door Frame,
97-06 Wrangler**

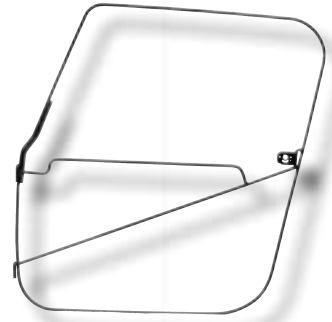

**13715.80 Door Frame,
76-86 CJ7**

Until now, these door frames have been very hard to find. Leave it to Rugged Ridge to solve yet another problem! Upper door steel frame for factory soft top Jeep® models. Update your top by replacing those worn out doors! Simply slip on your replacement door skins (sold separately as a part of our XHD Soft Top Kits) and you have up-graded that old top. Each frame is designed to fit factory soft top applications only. Sold as a pair. Rugged Ridge skins not available for CJ7.

Soft Top Door Frames	Part #
97-06 Wrangler, Pair *	13703.80
87-95 Wrangler, Pair *	13701.80
76-86 CJ7 & 76-83 CJ5, Pair ** (NEW)	13715.80

* Will only fit original style factory soft upper door skins
** Will only fit original style factory door skins

Soft Top and Window Storage Solutions

Prolong the life of your soft top or windows with this handy storage bag from Rugged Ridge. Features special soft sided fabrics that "cradle" your soft top or windows. Both solutions use oversized zippers and durable nylon fabrics for long life and weather resistance. Special handle placement allows for easy carrying and storage.



12106.01 Soft Top Storage Bag



12107.01 Window Storage Bag

Storage Bags, Black	Part #
Soft Top Storage Bag, Each	12106.01
Window Storage Bag, EAch (holds 2 windows)	12107.01



Hard Door Storage Bags



Prolong the life of your hard doors with this handy storage option from Rugged Ridge. Each storage bag features special soft sided fabric that "cradles" your hard door. We use oversized zippers and durable nylon fabrics for long life and weather resistance. Special handle placement allows for easy carrying and storage.

**12108.01 Hard Door
Storage Bag**



Storage Bags Have A Soft Interior To Cradle your Doors

Oversized Zippers & Durable Nylon Provide Years of Service

Storage Bags	Part #
Hard Door Storage Bag, Black	12108.01

Soft Top Storage Boot



Protect your soft top when it is folded down. Keeps soft top close by in case of sudden showers. Designed to be used with the windows zipped out.

Soft Top Storage Boot	Part #
07-10 Wrangler 2-Door, Black Diamond, Each (NEW)	12104.50
07-10 Wrangler 4-Door, Black Diamond, Each (NEW)	12104.51
97-06 Wrangler, Black Denim, Each*	12104.15
97-06 Wrangler, Spice, Each*	12104.37
46-95 CJ/Wrangler, Black Denim, Each	12105.15
46-95 CJ/Wrangler, Spice, Each	12105.37

* Will not fit Wrangler Unlimited

Rugged Ridge All Terrain Floor Liners for 1976-10 CJ & Wrangler



12920.01 Floor Liner, Front, 07-10 Wrangler



JK



The only floor liner with patent pending "Deep Tread" Technology!

These floor liners are a totally new concept that combines all the best features of a deep rib floor mat and the 'old style' liners. Precision engineering using state of the art technology ensures an exact fit to the shape and contour of your vehicle's floor. The deeply molded Chevron-shape tread pattern channels dirt, mud and snow away from the driver to keep shoes and pant legs clean. It also contains the movement and sloshing around of any trapped water. The high perimeter wall offers a large footprint and maximum interior protection and containment. Unlike ordinary liners that utilize an inconsistent vacuum thermoform process and slippery lower grade plastic these liners are high pressure injection molded from OE-quality Thermoplastic that looks and feels like rubber and provides a nonslip surface. Raised ribs on the bottom provide maximum retention and keep the liner in place. The unique self-sealing floor hook attachment feature helps to prevent dirt and moisture from getting through. Easy to remove and clean. Simply hose them off and go!!! The mat actually reseals itself around the hook!!! Patent pending.



12975.11 Cargo Liner, 97-06 Wrangler

Rugged Ridge Floor Liners & Cargo Liners

Part

Floor Liner, Front, 2 and 4-Door 07-10 Wrangler, Pair	12920.01
Floor Liner, Rear, 4-Door 07-10 Wrangler, One Piece Design	12950.01
Floor Liner, Rear, 2-Door 07-10 Wrangler, Pair	12950.02
Cargo Liner, 2 and 4-Door 07-10 Wrangler, Pair	12975.01
Floor Liner, Front, 97-06 Wrangler/Unlimited, Pair	12920.11
Floor Liner, Rear, 97-06 Wrangler/Unlimited, Pair	12950.10
Cargo Liner, 97-06 Wrangler/Unlimited	12975.11
Floor Liner, Front, 76-86 CJ7/CJ8, 87-95 Wrangler, Pair	12920.21
Cargo Liner, 76-86 CJ7, CJ8 & 87-95 Wrangler	12975.22
Floor Liner, Front, 76-86 CJ7/CJ8, 87-95 Wrangler, Pair, w/Jeep® Logo	DMC-12920.22
Cargo Liner, 76-86 CJ7/CJ8, 87-95 Wrangler w/Jeep® Logo	DMC-12975.22



Easy to clean design; simply hose off and go!



OFFICIAL LICENSED PRODUCT



NEW! Licensed Jeep® Logo Cargo Liners And Floor Liners Now Available For 76-95 CJ7/8 & Wrangler



The deeply molded Chevron shape tread pattern channels dirt, mud and snow away from the driver to keep shoes and pant legs clean. "Deep Tread" technology!

Self-sealing floor hook attachment feature helps to prevent dirt and moisture from getting through. The mat reseals itself around the hook!

The high perimeter wall offers a large footprint and maximum interior protection and containment.

The only Floor Liners with Deep Tread Technology!

NEW!

This is not your typical floor liner! Ordinary floor liners on the market today are constructed of extruded plastic materials vacuum formed to fit the vehicle. Rugged Ridge has taken a completely different approach to floor protection. Each All Terrain Floor Liner is injection molded for superior fit and quality. The injection molded process, though more expensive to develop, allows us to create a floor liner that has exacting measurements for better fit and finish along with a deeply formed perimeter wall for maximum coverage. Each All Terrain Floor Liner has chevrons that are up to 3/8" deep. That is up to 3 times the depth of other floor liners! We call this true "Deep Tread Technology"!

Year	Make/Model	Front	Rear	Kit
Chevy/GMC/Cadillac				
02-06	Avalanche (NEW)	82901.02	82950.01	82987.02
07-10	Avalanche (NEW)	82901.01	82950.01	82987.01
02-06	Escalade (NEW)	82901.02	82950.01	82987.02
07-10	Escalade (NEW)	82901.01	82950.01	82987.01
99-06	Silverado/Sierra 1500 Crew Cab (NEW)	82901.02	82950.01	82987.02
07-10	Silverado/Sierra 1500 Crew Cab (NEW)	82901.01	82950.01	82987.01
99-06	Silverado/Sierra 1500 Ext Cab (NEW)	82901.02	82950.01	82987.02
07-10	Silverado/Sierra 1500 Ext Cab (NEW)	82901.01	82950.01	82987.01
01-06	Silverado/Sierra 2500/3500 Crew Cab (NEW)	82901.02	82950.01	82987.02
07-10	Silverado/Sierra 2500/3500 Crew Cab (NEW)	82901.01	82950.01	82987.01
01-04	Silverado/Sierra 2500/3500 Ext Cab (NEW)	82901.02	82950.01	82987.02
00-06	Suburban (NEW)	82901.02	82950.01	82987.02
07-10	Suburban (NEW)	82901.01	82950.01	82987.01
00-06	Tahoe (NEW)	82901.02	82950.01	82987.02
07-10	Tahoe (NEW)	82901.01	82950.01	82987.01
00-06	Yukon (NEW)	82901.02	82950.01	82987.02
07-10	Yukon (NEW)	82901.01	82950.01	82987.01
Ford/Lincoln				
97-02	Expedition (NEW)	82902.05	82950.01	82987.25
97-03	F150 Ext Cab (NEW)	82902.04	82950.01	82987.24
04-08	F150 Ext Cab (NEW)	82902.01	82950.01	82987.21
09-10	F150 Ext Cab (NEW)	82902.03	82950.01	82987.23
97-03	F150 Reg Cab (NEW)	82902.04	82950.01	82987.24
04-08	F150 Reg Cab (NEW)	82902.01	82950.01	82987.21
09-10	F150 Reg Cab (NEW)	82902.03	82950.01	82987.23
01-03	F150 Super Crew (NEW)	82902.05	82950.01	82987.25
04-08	F150 Super Crew (NEW)	82902.01	82950.01	82987.21
09-10	F150 Super Crew (NEW)	82902.03	82950.01	82987.23
99-07	F250/F350 Super Duty (NEW)	82902.07	82950.01	82987.27
08-10	F250/F350 Super Duty (NEW)	82902.06	82950.01	82987.26
99-02	Lincoln Navigator (NEW)	82902.05	82950.01	82987.25
02-03	Lincoln Blackwood (NEW)	82902.05	82950.01	82987.25
06-08	Lincoln Mark LT (NEW)	82902.01	82950.01	82987.21
Dodge				
02-08	Ram 1500 Quad Cab (NEW)	82903.01	82950.01	82987.41
09-10	Ram 1500 Quad Cab (NEW)	82903.01	82950.01	82987.41
02-08	Ram 1500 Reg Cab (NEW)	82903.01	82950.01	82987.41
09-10	Ram 1500 Reg Cab (NEW)	82903.01	82950.01	82987.41
03-10	Ram 2500/3500 Quad Cab (NEW)	82903.01	82950.01	82987.41
06-10	Ram Mega Cab (NEW)	82903.01	82950.01	82987.41

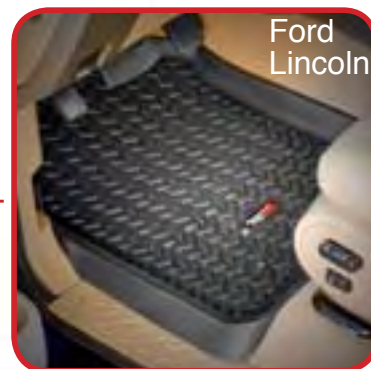

Dash Organizer for 2007-10 Wrangler

Looking for space to store that clutter? Introducing the new Rugged Ridge Dash Organizer for 2007-2010 Jeep Wranglers! This innovative new product incorporates existing mounting points to install a dual tray storage system right on your dash. Now you can easily store coins, pens, sunglasses, cell phones and other small items right in reach of both the passenger and driver. Installation is a snap; simply remove the original equipment screw covers on your dash, screw in the exclusive double headed mount and attach the Dash Organizer. It is that easy! Each Dash Organizer incorporates UV treated thermoplastic mounts and two trays with a painted aluminum cross tube for the ultimate in flexible design. Each tray can be mounted across the aluminum tube with thumb screw attachments. Rubber feet attached to the trays prevent rattling and provide a secure fit. The small tray has a special built in slot for MP3 players or cell phones with a belt clip (not included). Each tray has a special "recessed guide" that can be easily drilled out to create an out-of-the-way power cord locator. This exciting design has a low profile and does not interfere with driver visibility or air bag deployment.



Each Dash Organizer also includes a split bracket CB mounting kit and separate CB microphone holder for use with most smaller CB units. Holes in the bottom of the large tray have been pre-drilled for easy installation of these brackets and include a recessed area for optional out-of-the-way power cord use.



Mounts for Dash Organizer Mimic the Wrangler's Dash Speaker Design

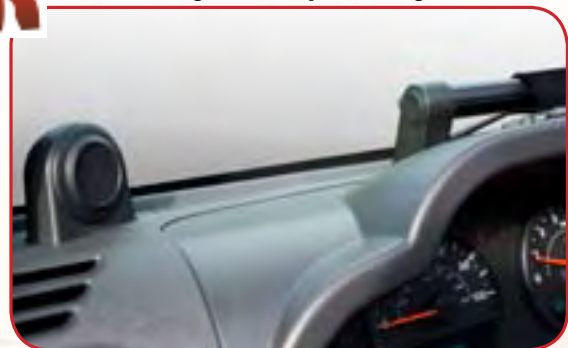

Note: Dash Organizer can be converted to fit right hand drive applications

Each Rugged Ridge Dash Organizer comes with a removable rubber tray liner which can be removed for cleaning while providing a rattle free surface for small items. Removal of liner exposes a smooth surface for use with suction cup accessories such as GPS, radar detectors, cell phone holders etc.

Rugged Ridge Dash Organizer

Part #

Rugged Ridge Dash Organizer, 07-10 Wrangler

13551.10

Rear Storage Bin for 2007-10 Wrangler



Protect your carpet from moisture, dirt, and grease with the exclusive Rugged Ridge storage bin for 07-10 Wrangler. This custom fit storage bin fits perfectly in the rear cargo area storage compartment providing protection and an easy to use removable tote. Molded from rigid and durable ABS plastic for a perfect contoured fit and long life. The unique chevron pattern matches the look of the All Terrain Floor and Cargo Liners. Each bin features integrated handles for ease of removal and cleaning.



JK

Rugged Ridge Storage Bin

Part

Rugged Ridge Storage Bin, 07-10 Wrangler

13122.01

JK Rear Seat Organizer

The perfect organization solution for your Jeep®! The new Rugged Ridge Back Seat Organizer features two separate storage areas to organize wayward trash, toys, drinks, iPods and other clutter. Each organizer is designed to instantly fit into the rear cup holders of your 2007-10 Jeep® Wrangler and includes a removable double walled lid. The large storage area will hold up to three 12oz. soda cans or two 16.9oz. water bottles with ice. The top lid can be easily removed creating a handy writing surface or small tray. The front tray can keep cell phones, iPods or other small items from rolling around the back seat. Easily removable to clean and empty, this truly is a must for your Jeep®!

NEW!



JK Rear Seat Organizer Description

Part

Rear seat organizer, Jeep Wrangler (JK) 07-10 (NEW) 13551.15



Sunglass Holder/Roll Bar Storage

Another perfect organization solution for your Jeep®! Allows you to stow your sunglasses, wallet, GPS, or other small accessories within arms reach. A perfectly sized zipper storage pouch allows for added storage right where you need it. Attaches easily to your sport bar using hook and loop fasteners-no drilling required

Sunglass Holder Description

Part

All Jeep Wranglers (NEW)

12101.52

NEW!

JK

Billet Aluminum Climate Control Knobs

Billet aluminum Wrangler Climate Control Knobs. These stylish knobs are easily installed by pulling off the factory knobs and pushing these back in their place. Choose red or blue colored inserts in the face of the knobs to illuminate at night and show their position.

11420.03 Climate Control Knobs, 99-06 Wrangler

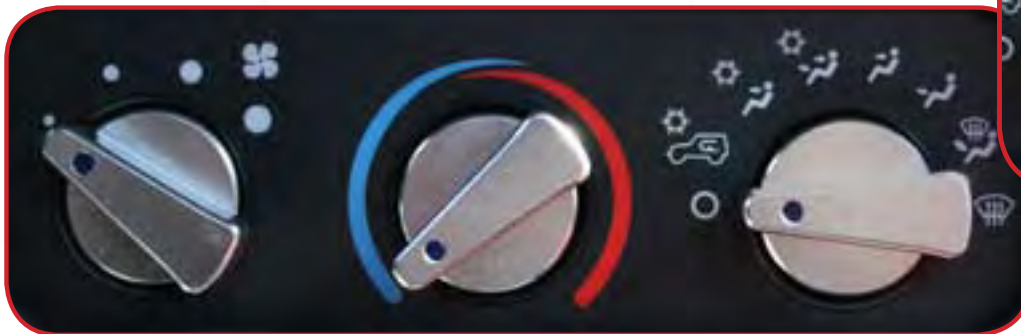

11420.04



11420.05

11420.06 Climate Control Knobs, 07-10 Wrangler

Billet Aluminum Climate Control Knobs

Part

07-10 Wrangler/Unlimited, Blue Indicator Lights, Set of 3	11420.05
07-10 Wrangler/Unlimited, Red Indicator Lights, Set of 3	11420.06
99-06 Wrangler/Unlimited, Blue Indicator Lights, Set of 3	11420.03
99-06 Wrangler/Unlimited, Red Indicator Lights, Set of 3	11420.04

Billet Shift Knobs

Upgrade the look of your Jeep® with a billet aluminum shift knob from Rugged Ridge. These highly polished shift knobs attach directly to your original equipment shifter with no drilling. Simply unscrew your current knob and replace it with the billet shift knob. There are two styles to choose from: a solid polished version and a shift pattern version. Do not forget to also replace the transfer case knob as well! The combination creates the ultimate look! Please measure your shift/transfer case threads before ordering.



5-Speed Shift Knob



11420.24 Transfer Case Knob

Billet Shift Knobs w/ Shift Pattern*

	Size	Part #
Fits most 97-06 Wrangler & some 94-95 models, Each	5 Speed, 10 mm x 1.5 metric	11420.20
Fits most 85-95 CJ/Wrangler & some 97-98 Wrangler, Each	5 Speed, 3/8"-16 threads	11420.22
Transfer Case Knob, 87-95 Wrangler, Each	w/T231 transfer case	11420.24

Billet Shift Knobs w/o Shift Pattern*

Fits most 97-06 Wrangler & some 94-95 models, Each	10 mm x 1.5 metric	11420.23
Fits most 85-95 CJ/Wrangler & some 97-98 Wrangler, Each	3/8"-16 threads	11420.21

* NOTE: please measure your gear shift thread size prior to ordering

Aluminum/Stainless Instrument Knob Set

Give your boring dash controls a step up in style with these instrument knobs. Sold as a 6-piece set.

Application	Finish	Part #
76-86 Jeep® CJ, Set of 6	Polished Aluminum	11420.01
76-86 Jeep® CJ, Set of 6	Black Aluminum	11420.02
76-86 Jeep® CJ, Set of 6	Stainless Steel	11126.01
76-86 Jeep® CJ, Set of 6	Black Steel	11126.02





Brushed Silver/Chrome Interior Trim For 2007-10 Wrangler

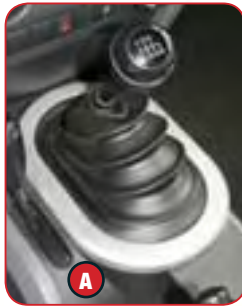

11151.01 Brushed Silver Shifter Trim

Make your 07-10 Wrangler unique with Rugged Ridge interior accents. These injection-molded plastic accents are molded directly from the factory interior pieces for an exact fit. Installation is a snap thanks to the pre-installed high-strength adhesive tape. Available in brushed silver (matches factory Rubicon interior trim pieces) or chrome finish.



11151.10 Brushed Silver AC Vent Trim



11156.10 Chrome AC Vent Trim

2-Door Kits include accents for: Shifter, AC Vent Covers, Tweeter Speakers, Steering Wheel, Front Clip Holder, Dash Panel, Grab Handle, Front Door Handles, and Front Door Pulls.

4-Door Kits include all the accents in the 2-Door Kit plus Rear Door Handles & Rear Door Pulls.

Interior Kits	Brushed Silver	Chrome
2-Door with Manual Transmission (includes all applicable items listed below) (NEW)	11151.90	11156.90
2-Door with Automatic Transmission (includes all applicable items listed below) (NEW)	11151.91	11156.91
4-Door with Manual Transmission (includes all applicable items listed below) (NEW)	11151.95	11156.95
4-Door with Automatic Transmission (includes all applicable items listed below) (NEW)	11151.96	11156.96

Components	Brushed Silver	Chrome
A. Shifter Trim Manual Transmission (NEW)	11151.01	11156.01
B. Shifter Trim Automatic Transmission (NEW)	11151.02	11156.02
C. AC Vent Cover (Pair) *Need 2 pairs (NEW)	11151.10	11156.10
D. Tweeter Speaker Grille (Pair) (NEW)	11151.11	11156.11
E. Steering Wheel Spoke Accents (Set) (NEW)	11151.12	11156.12
F. Front Cup Holder Trim (NEW)	11151.13	11156.13
G. Dash Panel Accent Trim (Pair) (NEW)	11151.14	11156.14
H. Grab Bar Handle (NEW)	11151.15	11156.15
I. Interior Door Handle Covers (Pair) *Need 2 pairs for 4-Door (NEW)	11151.20	11156.20
J. Front Door Pull Handle (Pair) (NEW)	11151.16	11156.16
K. Rear Door Pull Handle (Pair) *Not pictured. (For 4-Door Only) (NEW)	11151.17	11156.17

NEW!

JK

Interior Trim Items

Standard Replacement High Back Seats



13401.01 Standard Replacement High Back Set, Black

Want all the strength and comfort of our reclining seat but without the recliner? Look no further! The Standard Replacement Seat from Rugged Ridge offers all the great quality benefits of our reclining seat but we have removed the reclining mechanism. This low cost alternative gives you the value and quality you are looking for, but is priced less. Also available in the Standard series is our Low Back Replacement Seat (on page 41). This seat is specially designed for those earlier Jeep® restoration projects and uses the original mounting hardware and bolts from the original seats.



Standard High Back Front Seat For 76-02 Jeep CJ/Wrangler *

Black	Blue	Tan	Nutmeg	Grey	Black Denim	Spice
13401.01	13401.05	13401.04	13401.07	13401.09	13401.15	13401.37

NOTE: 97-02 Wranglers require front seat adapter brackets 13201.11 (for driver side) and 13201.12 (for passenger side) for these seats to mount on the factory seat brackets. See page 42.

Factory Style Replacement Seat with Recliner



13402.09 Factory Style Replacement Seat with Recliner

Replacement seating that reclines just like the original! All Rugged Ridge Seating is manufactured to exacting specifications to guarantee only the highest quality. Each seat is constructed of durable automotive grade vinyl that is designed to match your vehicles interior and all Rugged Ridge rear seats. All frames are powder coat painted and welded to make sure it can take those off-road adventures and years of open air use. The foam pack and spring system used on all Rugged Ridge Seats is extremely dense for long life yet soft enough for true comfort. Soft side bolsters "cradle" the driver making driving a pleasure. Each seat features an infinitely adjustable reclining mechanism to ensure proper driving position and the ultimate in comfort. All Rugged Ridge seats feature a stylish stitch pattern and original equipment bolt pattern for ease of installation and a great original equipment look. Simply remove the old seat and bolt in the new!

13403.37 Factory Style Replacement Seat with Integrated Head Rest, 76-02 CJ/Wrangler, Spice



13402.15 Factory Style Replacement Seat, 76-02 CJ/Wrangler, Black



13402.01 Factory Style Replacement Seat Reclining in Different Positions

Factory Style Replacement Seats with Recliner *	Black	Tan	Nutmeg	Grey	Black Denim	Spice
76-02 CJ/Wrangler	13402.01	13402.04	13402.07	13402.09	13402.15	13402.37
76-02 CJ/Wrangler w/late model headrest	-	-	-	13403.09	13403.15	13403.37
All Suzuki® Samurai, Driver Side	-	-	-	53420.09	-	-
All Suzuki®, Passenger Side	-	-	-	53421.09	-	-

NOTE: 97-02 Wranglers require front seat adapter brackets 13201.11 (for driver side) and 13201.12 (for passenger side) for these seats to mount on the factory seat brackets.

* **⚠ WARNING:** Caution: replacement seating is offered for restoration or off-road use only. Replacement seats are provided by third party vendors and are not represented as meeting FMVSS standards.

The Super Seat

This might be the last seat you will ever own for your Jeep®! Luxuriously soft side and bottom bolsters cradle you in comfort while providing stability on those off-road trails. Each seat features an infinitely adjustable reclining mechanism to ensure proper driving position and the ultimate in comfort. The adjustable head rest is secured by dual steel rods and backed by a powder coat steel reinforcement plate that is surrounded by dense poured foam. The main structure is powder coat painted steel with heavy-duty suspension springs creating a rigid support frame. This frame is then surrounded by the best poured foam you can buy and wrapped in tough automotive grade vinyl fabric. Comfort, strength and stability all in one seat! As with all Rugged Ridge seating, all feature a stylish stitch pattern and original equipment bolt pattern for ease of installation and a great look. Simply remove the old seat and bolt in the new!



13404.37 Super Seat, Spice

13404.09 Super Seat, Grey



13404.15 Super Seat, Black

The Anatomy of a Super Seat



The Sport Seat

Want that racing look at a great price? Look no further as the Rugged Ridge Sport Seat gives you both. This exciting new design features all the great quality features found on our factory replacement reclining seats but also has over sized bolsters for secure off-road driving comfort. Special cut-outs on the top of the seat give this seat that racing look and feel. The Sport Seat uses the original equipment bolt pattern for ease of installation.



13405.09 Sport Seat, Grey



13405.15 Sport Seat, Black Denim



13405.37 Sport Seat, Spice



	Application	Black	Grey	Black Denim	Spice
The Super Seat, Each *	76-02 CJ/Wrangler	13404.01	13404.09	13404.15	13404.37
The Sport Seat, Each *	76-02 CJ/Wrangler	-	13405.09	13405.15	13405.37

All Seats being installed on 97-02 Jeep® Wranglers require an optional front seat adaptor bracket: Drivers Side 13201.11 / Passengers Side 13201.12

* **WARNING** Caution: replacement seating is offered for restoration or off-road use only. Replacement seats are provided by third party vendors and are not represented as meeting FMVSS standards.

RRC Reclining Racing Seat

You have seen the rest, now here is the best! More features, more comfort, and the best pricing of any racing seat design. Each seat features dual reclining mechanisms allowing for infinite reclining positions. The special "Jeep® Specific" design uses ultra dense foam and steel construction for greater comfort and long life. Side bolsters have been slightly expanded and designed specifically for both lifted and non-lifted Jeep® vehicles. Special air adjustable lumbar support provides the most comfortable back support in a racing seat design. Woven fabric and vinyl construction give the ultimate in comfort and wearability. Each seat has three seat belt harness cutouts for use with a multi-point racing harness seatbelt. 1997-02 models require the Rugged Ridge mounting bracket for installation (shown below).

13406.53 RRC Reclining Racing Seat



Available in 3 Colors

13406.15 RRC Reclining Racing Seat



13406.09 RRC Reclining Racing Seat



Expanded Side Bolsters

LH/RH Switchable Lumbar Bulb

Adjustable Lumbar Support



Woven Fabric & Vinyl

Seat Belt Harness Cutouts

Dual Reclining Mechanism

RRC Reclining Racing Seat *	Red/Black	Black/Black	Grey/Black
76-02 CJ & Wrangler, Each	13406.53	13406.15	13406.09

Seat Riser

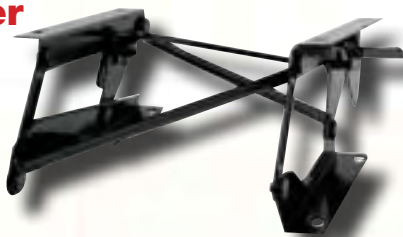

Replace your worn seat risers or upgrade your current riser. They are designed for easy attachment of seat sliders (sold separately) which will attach to any aftermarket or OE Jeep® seat.

Seat Riser	Part #
Driver Side, 76-95 CJ/Wrangler, Each	13201.01
Passenger Side, 76-95 CJ/Wrangler, Each	13201.02

Replacement Seat Slider

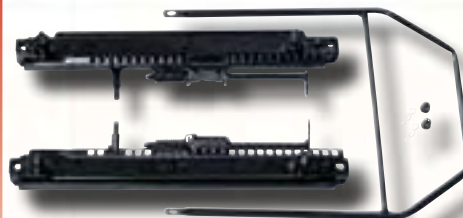

Designed to be used with Rugged Ridge or factory seat risers, these heavy-duty sliders allow the seat to slide forward and back. Each seat riser is sold separately so you will need two, one for each front seat!

Seat Slider	Part #
Seat Slider 76-95 CJ/Wrangler, Each	13201.03



Seat Adapters

Required equipment for installing replacement seats on 97-02 Jeep® Wrangler vehicles. Designed for both Rugged Ridge and Outland replacement Jeep® seats.

Seat Adapters	Part #
Driver Side, 97-02 Wrangler	13201.11
Passenger Side 97-02 Wrangler	13201.12



* **WARNING:** Caution: replacement seating is offered for restoration or off-road use only. Replacement seats are provided by third party vendors and are not represented as meeting FMVSS standards.

Standard Low Back Seats

Want all the strength and comfort of our reclining seat but without the recliner? Look no further! The Standard Replacement Seat from Rugged Ridge offers all the great quality benefits of our reclining seat but we have removed the reclining mechanism. This low cost alternative gives you the value and quality you are looking for but is priced less. This seat is specially designed for those older Jeep® restoration projects and uses the original mounting hardware and bolts from the original seats.

13400.01 Standard Low Back Seat, Black



13400.04 Standard Low Back Seat, Tan



Standard Low Back Front Seats *

Application	Black	Tan
55-86 CJ, Each	13400.01	13400.04

NOTE: 1955-75 models may require modification of vehicle



Fold & Tumble Rear Seats

Need more rear storage space in the back of your Jeep®? Simply “fold and tumble” the Rugged Ridge Rear Fold and Tumble Seat and you create instant cargo space. Each seat is constructed of durable automotive grade vinyl that is designed to match your vehicles interior and all Rugged Ridge front seats. Each frame is powder coat painted and welded to make sure it can take those off-road adventures. The foam pack used on all Rugged Ridge Seats is extremely dense for long life yet soft enough for true comfort. Installation is easy with attachments to existing mounting points and minimal drilling required. Uses existing seat belts.



13462.09 Fold & Tumble Rear Seat



EASY AS 1-2-3
Just fold the seat back forward, and tumble the whole seat up and out of the way

Fold & Tumble Rear Seats *	Black	Tan	Nutmeg	Grey	Black Denim	Spice
86-95 CJ/Wrangler, Each	13462.01	13462.04	13462.07	13462.09	13462.15	13462.37
97-02 Wrangler, Each	-	-	-	13463.09	13463.15	13463.37

Standard Rear Seat

Looking for a tough rear seat that does not fold and tumble? Look no further as the Standard Rear Seat from Rugged Ridge is the economical solution. Like the Fold and Tumble versions, these tough rear seats are constructed of durable automotive grade vinyl that is designed to match your vehicle's interior and all Rugged Ridge front seats. The frame and all brackets are powder coat painted and welded to ensure a long life. Each seat is bolted directly to your vehicles floor board with minimal drilling required. Uses existing seat belts.



13461.01 Standard Rear Seat

Standard Rear Seats *	Black	Tan	Nutmeg	Grey	Black Denim
55-95 CJ / Wrangler, Each	13461.01	13461.04	13461.07	13461.09	13461.15

* **⚠️ WARNING:** Caution: replacement seating is offered for restoration or off-road use only. Replacement seats are provided by third party vendors and are not represented as meeting FMVSS standards.

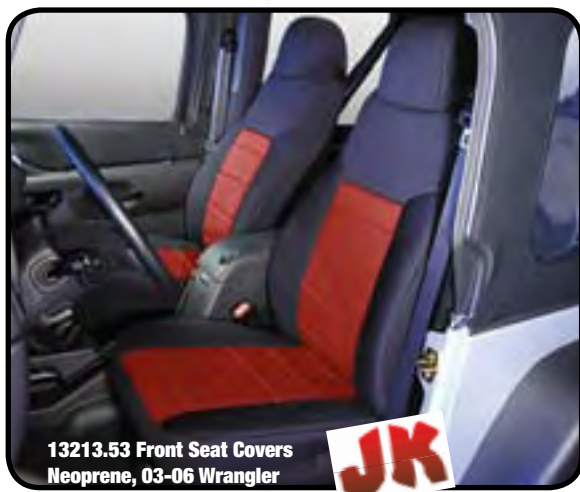

13213.53 Front Seat Covers
Neoprene, 03-06 Wrangler

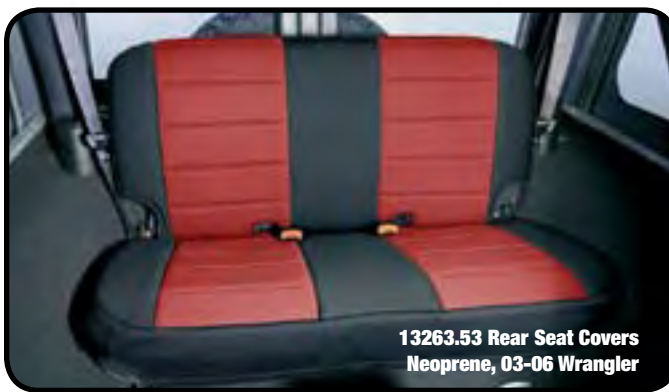

13263.53 Rear Seat Covers
Neoprene, 03-06 Wrangler

Custom Fit Neoprene & Poly Cotton Seat Covers

Custom Neoprene Seat Covers	Black/Black	Black/Tan	Black/Grey	Black/Red
Front, 07-10 Wrangler with or without Side Airbags, Pair	13214.01	-	13214.09	13214.53
Front, 03-06 Wrangler, Pair	13213.01	13213.04	13213.09	13213.53
Front, 97-02 Wrangler, Pair	13210.01	13210.04	13210.09	13210.53
Front, 91-95 Wrangler, Pair	13211.01	13211.04	13211.09	13211.53
Front, 76-90 CJ/Wrangler, Pair	13212.01	13212.04	13212.09	13212.53
Rear, 07-10 Wrangler 4-Door, Pair	13264.01	-	13264.09	13264.53
Rear, 07-10 Wrangler 2-Door, Pair	13265.01	-	13265.09	13265.53
Rear, 03-06 Wrangler, Pair	13263.01	13263.04	13263.09	13263.53
Rear, 97-02 Wrangler, Pair	13261.01	13261.04	13261.09	13261.53
Rear, 80-95 CJ / Wrangler, Pair	13262.01	13262.04	13262.09	13262.53



Protect your Jeep's® interior with these two great Seat Cover options: Custom Fit Neoprene Seat Covers or Custom Fit UV treated Poly Cotton Seat Covers, both from Rugged Ridge. These covers are constructed of either durable neoprene or tough poly cotton fabric creating the best looking custom seat cover available. Rugged Ridge does not use that cheap stretch nylon on their seat covers! Neoprene (wetsuit material) is a great fabric to protect your seats from dirt, water and whatever mother nature can throw at you. Poly Cotton is a great fabric to protect your seats from dirt, sweat and heat from the sun. No more burned legs from hot vinyl seats! Each cover is custom tailored for your Jeep's® original equipment seat style making your seats look like they have been recently re-upholstered. Installation is easy with special designed elastic cords, nylon straps and hooks that attach to your seat and to the seat cover mounting points. Available in black on black, grey on black, red on black (neoprene models only) and tan on black to complement virtually any Jeep® interior. 2003-2010 models have the center section stop before the headrest. All other models have the center portion (color) going all the way to the top of the seat.



13264.09 Rear Seat Covers, Neoprene, 07-10 Wrangler, Includes Separate Headrest Covers



13214.01 Front Seat Covers, Neoprene, 07-10 Wrangler, Includes Separate Headrest Covers



13282.09 Rear Seat Covers
Poly Cotton, 03-06 Wrangler



13243.09 Front Seat Covers
Poly Cotton, 03-06 Wrangler

Custom Fit Poly Cotton Seat Covers	Black/Black	Black/Tan	Black/Grey
Front, 03-06 Wrangler, Pair	13243.01	13243.04	13243.09
Front, 97-02 Wrangler, Pair	13240.01	13240.04	13240.09
Front, 91-95 Wrangler, Pair	13241.01	13241.04	13241.09
Front, 76-90 CJ/Wrangler, Pair	13242.01	13242.04	13242.09
Rear, 03-06 Wrangler, Each	13282.01	13282.04	13282.09
Rear, 97-02 Wrangler, Each	13281.01	13281.04	13281.09
Rear, 80-95 CJ/Wrangler, Each	13280.01	13280.04	13280.09

Available in Durable Neoprene
or Tough UV Treated Poly Cotton



**76-06 CJ/Wrangler
Neoprene Model**

**76-06 CJ/Wrangler
Fabric Model**

Seat Protectors

Protect your seats from the elements with these easy to install Seat Protectors. Constructed of durable UV treated poly cotton fabric or soft water resistant neoprene to ensure comfort and protection. Each Seat Protector incorporates extra storage on the rear of the cover plus a removable drink holder. Easy to install, these covers fit over all bucket Jeep® seats including all Rugged Ridge replacement seats. Sold in pairs to cover your entire front seating area.

Seat Protector	Part #
76-06 All Jeeps® Black Fabric, Pair	13235.01
76-06 All Jeeps® Grey Fabric, Pair	13235.09
76-06 All Jeeps® Spice Fabric, Pair	13235.37
76-06 All Jeeps® Black/Grey Neoprene, Pair	13235.19

Neoprene Seat Protectors for 2007-10 Wrangler

Protect your seats from the elements, wet bathing suits and spills while providing a great look. Each set of seat protectors includes back pockets for rear storage as well as a removable cup holder. Cushioned center portion gives the Seat Protector a great look and provides you extra comfort on those long road trips. New solid color design further enhances the look of your Jeep®.



13235.20 Seat Protector, Black, 07-10 Wrangler



Lots of Extra Storage

07-10 Wrangler Neoprene Seat Protector	Black	Grey
With Factory Side Air bags, Pair	13235.30	13235.32

Arm Rest Pad for 2007-10 Wrangler



Black / Grey Neoprene Model



Black Diamond Vinyl Model

Rugged Ridge's Patented Arm Rest Pad bolts directly into existing JK mounting screws-no need to remove the OE lid. Steel brackets ensure durability. Uses either Neoprene or tough vinyl coated polyester fabric with a dense foam center for comfort, performance and a great look in the vehicle. Allows for full opening and closing of the console lid. No drilling required.

Arm Rest Pad For 07-10 Wrangler	Part #
Black Diamond Vinyl, Each	13107.35
Black/Grey Neoprene, Each	13107.09
Black Neoprene, Each	13107.01

Ultimate Locking Console

Standard Locking Console



Rugged Ridge II Locking Console



Replacement Center Consoles

Rugged Ridge Consoles are the ultimate storage solution for your CJ or early model Wrangler. Each console is constructed of durable Jeep® interior matching vinyl wrapped around plastic coated hard wood to keep moisture out and provide a great looking addition to your Jeep®. Each console is hand made to ensure a tight, wrinkle free finish. All Rugged Ridge Consoles feature a six can cooler, all mounting hardware and a dense foam arm rest for long life and a comfortable feel. Need lockable storage? No problem. All Rugged Ridge Consoles incorporate a locking mechanism to deter access to the storage compartments. Available in three unique styles and sizes, Rugged Ridge Consoles are the best storage solution available.



Rugged Ridge II Consoles feature dual adjustable cup holders, removable soft sided CD holder, two oversized storage areas, back seat cup holders and a rear map pocket.

Ultimate Locking Consoles feature dual front cup holders, removable CD tray, can cooler, coin storage tray and sunglass holder.

Replacement Center Consoles

Black

Grey

Black Denim

Spice

Standard Locking Console, 76-95 CJ/Wrangler 24"Lx8.75"Wx12.5"H

13101.01

13101.09

13101.15

13101.37

Ultimate Locking Console, 76-95 CJ/Wrangler 27.25"Lx8.75"Wx12.5"H

13102.01

13102.09

13102.15

13102.37

Rugged Ridge II Locking Console, 76-95 CJ/Wrangler 27.25"Lx8.25"Wx12.25"H

-

13103.09

13103.15

13103.37

SUV/Jeep Storage Bag

Custom designed to provide removable storage for Jeep® vehicles. Special size fits behind rear seat to organize and store your cargo. Constructed of durable vinyl with a zipper top and removable cargo dividers - easy to use shoulder strap included.

Jeep®/SUV Storage Bag, Universal all Jeep®

13551.01



Off-Road Organizer

Custom design for use in Jeep® glove boxes. Special pockets allow you to effectively organize owners manuals, maps, tire gauges, vehicle registration and more. Constructed of durable nylon in a tri-fold configuration.



Sound Bars

Pump up the music with these high fidelity Sound Bars from Rugged Ridge. Designed to fit directly behind the center hoop of all 87-06 Jeep® Wranglers and Unlimited vehicles, these Sound Bars are one stop 200 watt peak power "sound machines". The six speaker pre-wired bar features a 40-22,000 Hz frequency response. Outstanding midrange from a pair of 2" midrange speakers, thumping bass from the two 6.5" woofers and a pair of 1" tweeters for exceptional high frequencies make the Six Speaker Bar sing! The Two Speaker pre-wired speaker bar features a 100-20,000 Hz frequency response for dynamic sound quality. All Rugged Ridge Sound Bars include dual map lights and mounting hardware.



13006.15 Upholstered Six Speaker Sound Bar



Six Speaker Sound Bar



Two Speaker Sound Bar



Sound Bar w/o Speaker



Upholstered models available

Sound Bars	Textured Black	Upholstered Grey	Black Denim	Spice Denim
Sound Bar, 2 Speaker, 87-06 Wrangler/Unlimited, Each	13001.51	13001.09	13001.15	13001.37
Sound Bar, 6 Speaker, 87-06 Wrangler/Unlimited, Each	13006.01	13006.09	13006.15	13006.37
Sound Bar w/o Speakers, 87-06 Wrangler/Unlimited (Includes Lights), Each *	13001.61	-	-	-

* does not include wiring for speakers

Sound Boxes

- Tough Roto-molded plastic design protects from harsh weather
- Two speaker design; two way bottom speaker with a high frequency tweeter mounted on top for a great sound
- Available with or without speakers in two interior matching colors
- Packed in pairs with mounting hardware and all needed wiring

Sound Boxes	Black	Spice
97-06 Wrangler w/ Speakers, Pair	13004.01	13004.37
97-06 Wrangler w/o Speakers, Pair	13003.01	13003.37

13004.37 Sound Boxes with Speaker

13003.01 Sound Boxes without Speakers

13004.01 Sound Box with Speaker

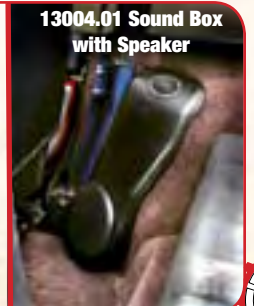

Fire Extinguisher Holders

Special designed holder incorporates thick nylon web straps that secures your Fire extinguisher to the roll bar. Straps are fully adjustable and secure with hook and loop fasteners. Holds one 3lb. fire extinguisher (not included).



13305.20



13305.21

Roll Bar Fire Extinguisher Holder

Black

Red

For all Jeep® 3" Roll Bars, Each

13305.21

13305.20

For Early CJ & 1"-2" Roll Bars, Each

63305.21

63305.20

Replacement Sun Visors

Replace those old, worn or missing sun visors with these original equipment replicas. Constructed of durable interior matching vinyl with a built in metal attachment rod. Sold in pairs. Easily mounts with the factory original mounting hardware (not included).



13312.01 13312.09 13312.15 13312.37

Replacement Sun Visors for Jeep® Wrangler (sold in pairs)

Application	Black	Grey
87-95 Wrangler, Pair	13312.01	13312.09
72-86 CJ, Pair	13301.01	13301.09

Application	Charcoal	Spice
87-95 Wrangler, Pair	13312.15	13312.37
72-86 CJ, Pair	13301.15	13301.37

Roll Bar Drink Holder



beverage cool in the hot summer sun. Packed in pairs for both front and back seat use.

Quickly places a convenient drink holder anywhere along your Jeeps® Sport Bars. Padded nylon drink holders attach with quick release "hook & loop" straps and hold a variety of cups and water bottle sizes. Foam insulation keeps your favorite

Roll Bar Drink Cup Holder

Part #

For all Jeep® Roll Bars, Pair

12101.51

For Early CJ & 2" Roll Bars, Pair

62101.51

Drink Cup Holder



This durable cup holder attaches to the factory bolts on the windshield giving you a handy location for your favorite beverage. Constructed of durable rigid/ribbed plastic, these cup holders are designed not to shake.

Drink Cup Holder

Part #

76-95 CJ/Wrangler, Each

13306.01

Roll/Pitch Indicator



Rugged Ridge offers two styles of Clinometers for those off-road adventures.

Each style features two gauges: left displays side by side angle and the right displays front to back angle. Each display has a graphic read out that shows angles in degrees for quick reference. Choose from the Compass model that has a floating compass in the middle or the lighted version for night time use (some wiring required). Each attach to the dash of your Jeep® with automotive grade double sided tape or can be permanently mounted with screws.

Clinometer

Part #

With compass, Each

13309.01

With light, Each

13309.02

Tailgate Stop



Keep your rear tailgate door open while loading your Jeep® with the new Tailgate Stop from Rugged Ridge. This billet aluminum door stop incorporates a sliding arm that locks into place keeping your tailgate door open even on the most severe slopes. Load your Jeep® with ease! Some drilling required to install on the inside of your tailgate.

Tailgate Stop

Part #

87-10 Wrangler, Each

11238.11

Roll Bar Dome Light



Hard wired light illuminates the cab area of your Jeep®. Attaches to the roll bar with easy to use straps. No drilling required.

Roll Bar Dome Light

Part #

For all Jeeps® Roll Bars

11250.01

Roll Bar Coat Hanger Kit



11250.03 Roll Bar Coat Hanger

Makes hanging your coat or laundry easy. Attaches to the roll bar with two nylon straps. Sold in pairs.

Roll Bar Coat Hanger

For all Jeeps® w/ Roll Bars

11250.03

Back Seat Heater



Keep your Jeep® warm in the winter with the Rugged Ridge Back Seat Heater. This 300 watt, 12 volt heater will warm your vehicle quickly keeping you and your passengers comfortable. Designed to fit on the rear wheel well of any Jeep®, this easy to use heater wires easily to your existing electrical system. Some drilling may be required.

Back Seat Heater

Part #

All Jeeps® & SUV's

13150.01

Replacement Carpet

Replacement Carpet	Part #
76-95 CJ7/Wrangler, Black, 6 pc. Set	13690.01
76-95 CJ7/Wrangler, Grey, 6 pc. Set	13690.09
76-95 CJ7/Wrangler, Honey, 6 pc. Set	13690.10
97-06 Wrangler, Black, 6 pc. Set	13691.01
97-06 Wrangler, Grey, 6 pc. Set	13691.09
97-06 Wrangler, Honey, 6 pc. Set	13691.10

Note: These kits require the purchase of spray adhesive which can be found at any hardware store.

**Electronically Surged
Edge Will Not
Unravel**

Nothing refreshes the inside of a vehicle like new carpet. This NEW design provides Tufted Polypropylene carpet with electronically surged edges that will not unravel. Polypropylene is a space-age polymer chosen for its rugged durability and resistance to chemical solvents and mildew. Full interior design includes tailgate and wheel well coverage. Features jute backing and driver side vinyl heel guard. Thanks to the sound deadening properties of the carpet, interior noise will also be reduced. The precut six-piece design is made for your vehicle to ensure proper fitment. Available in three popular and attractive colors to match your Jeep's® interior.



Billet Aluminum Climate Control Knobs



11420.06 Climate Control Knobs, 07-10 Wrangler



11420.03 Climate Control Knobs, 99-06 Wrangler

Billet Aluminum Climate Control Knobs	Part #
07-10 Wrangler/Unlimited, Blue Indicator Lights, Set of 3	11420.05
07-10 Wrangler/Unlimited, Red Indicator Lights, Set of 3	11420.06
99-06 Wrangler/Unlimited, Blue Indicator Lights, Set of 3	11420.03
99-06 Wrangler/Unlimited, Red Indicator Lights, Set of 3	11420.04

Billet aluminum Wrangler Climate Control Knobs. These stylish knobs are easily installed by pulling off the factory knobs and pushing these back in their place. Choose red or blue colored inserts in the face of the knobs to illuminate at night and show their position.

Billet Shift Knobs

Upgrade the look of your Jeep® with a billet aluminum shift knob from Rugged Ridge.

These highly polished shift knobs attach directly to your original equipment shifter with no drilling.

Simply unscrew your current knob and replace it with the billet shift knob. There are two styles to choose from: a solid polished version and a shift pattern version.

Do not forget to also replace the transfer case knob as well!

The combination creates the ultimate look! Please measure your shift/transfer case threads before ordering.



**5-Speed
Shift Knob**

**11420.24 Transfer
Case Knob**

Billet Shift Knobs w/ Shift Pattern*	Size	Part #
Fits most 97-06 Wrangler & some 94-95 models, Each	5 Speed, 10 mm x 1.5 metric	11420.20
Fits most 85-95 CJ/Wrangler & some 97-98 Wrangler, Each	5 Speed, 3/8"-16 threads	11420.22
Transfer Case Knob, 87-95 Wrangler, Each	w/T231 transfer case	11420.24

Billet Shift Knobs w/o Shift Pattern*

Fits most 97-06 Wrangler & some 94-95 models, Each	10 mm x 1.5 metric	11420.23
Fits most 85-85 CJ/Wrangler & some 97-98 Wrangler, Each	3/8"-16 threads	11420.21

* NOTE: please measure your gear shift thread size prior to ordering

Aluminum/Stainless Instrument Knob Set

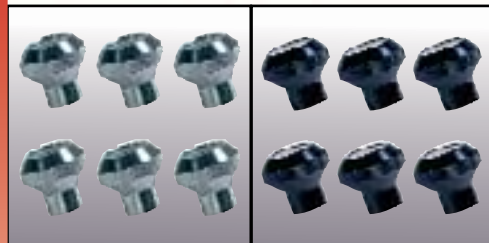

Give your boring dash controls a step up in style with these instrument knobs. Each sold as a 6-piece set.

Application	Finish	Part #
76-86 Jeep® CJ	Polished Aluminum	11420.01
76-86 Jeep® CJ	Black Aluminum	11420.02
76-86 Jeep® CJ	Stainless Steel	11126.01
76-86 Jeep® CJ	Black Steel	11126.02

Trail Arm Rests



11820.21 Trail Arm Rest, 97-06 Wrangler



The most versatile and comfortable arm rest ever created for a Jeep®. Each arm rest provides comfortable cushioning while on the trail or just driving around town. Each arm rest fits all 87-06 Jeep® Wrangler hard half doors (with or without upper door in place) plus all 76-06 Bestop® Supertop™ half doors. Constructed of durable black nylon covered high density foam and powder coated steel for long life and great looks. Installation is quick and easy using the factory upper door mounting holes.

Trail Arm Rests	Part #
87-06 Wrangler Hard Half Doors & All Bestop® 76-06 Supertop Half Doors, Pair	11820.20
87-06 Wrangler Hard Half Doors & All Bestop® 76-06 Supertop Half Doors, Each (L,R)	11820.21

Replacement Door Straps/Handles



97-06 Door Handle Replacement 11826.01

Upgrades/replaces factory hard door handles with tough nylon webbing and an easy grip handle. Installs directly into the factory mounting positions. The 97-06 model includes a special mounting tool to make installation easy.



76-95 Door Handle Replacement 11825.01

Replacement Door Straps/Handles	Black
76-95 CJ/Wrangler Door Strap / Handle, Pair	11825.01
97-06 Wrangler Door Strap / Handle, Pair	11826.01

Hard Door Arm Rest



11830.01 Hard Door Arm Rest, 87-95 Wrangler

Replace your door pull strap with this easy to use arm rest. Soft padded vinyl design provides comfort while driving. Easy to install, simply remove current pull strap and mount to existing holes. No drilling required. Works on all Wrangler full steel doors.

Hard Door Arm Rest, Full Hard Doors	Part #
87-95 Wrangler, Pair	11830.01
97-06 Wrangler/Unlimited, Pair	11830.02

Arm Rest Pad for 2007-10 Wrangler

Rugged Ridge's Patented Arm Rest Pad bolts directly into existing JK mounting screws-no need to remove the OE lid. Steel brackets ensure durability. Uses either Neoprene or tough vinyl coated polyester fabric with a dense foam center for comfort, performance and a great look in the vehicle. Allows for full opening and closing of the console lid. No drilling required.



13107.09 Arm Rest Pad, Black/Grey Neoprene

Arm Rest Pad For 07-10 Wrangler	Part #
Black Diamond Vinyl, Each	13107.35
Black/Grey Neoprene, Each	13107.09
Black Neoprene, Each	13107.01

Neoprene Grab Handle and Door Handle Covers

Protect and upgrade the look of your Wrangler with these easy to install door and grab handle wraps. Each wrap is constructed of durable neoprene and covers each door handle as well as the passenger side grab handle. Four door models include 5 pieces (Grab Handle and four door handles) while two door models have 3 pieces (Grab Handle and two door handles).



Easy Installation Using Hook & Loop Fastening System!

Grab & Door Handle Kit	Black	Red
07-10 Wrangler 4-Door, 5 pc. Kit	13305.54	13305.55
07-10 Wrangler 2-Door, 3 pc. Kit	13305.56	13305.57
97-06 Wrangler, 3 pc. Kit	13305.52	13305.53
87-95 Wrangler, 3 pc. Kit	13305.50	13305.51



Black, Stainless and Aluminum Entry Guards



11119.05 Entry Guards, 4-Door 07-10 Wrangler, Stainless

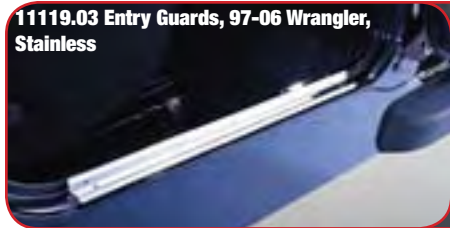

11119.03 Entry Guards, 97-06 Wrangler, Stainless



11238.21 Entry Guards, 76-06 Wrangler Aluminum

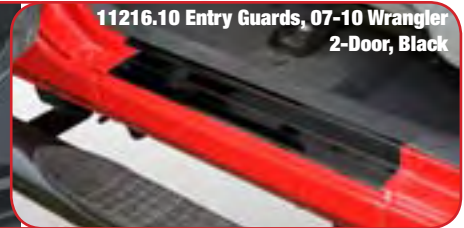

11216.10 Entry Guards, 07-10 Wrangler 2-Door, Black

Protect your door threshold with these stylish entry guards. Available in three different finishes, black, polished stainless and aluminum to enhance the look of your Jeep® while providing the ultimate in protection. 2007-10 Wrangler entry guards available for 2 & 4-Door models (2-Door kits will fit front 4-Door applications). 2007-10 Wrangler models attach without screws using durable double sided tape.

Entry Guards	Stainless	Black	24" Aluminum
07-10 Wrangler Front Door Openings Only (2 & 4-Door) Pair	11119.04	11216.10	-
07-10 Wrangler 4-Door Openings, 4 pc. Kit	11119.05	11216.11	-
97-06 Wrangler, Pair	11119.03	11216.01	11238.21
76-95 CJ/Wrangler, Pair	11119.02	-	11238.20
55-83 CJ5, Pair	11119.01	-	-



Door Light Spring Clips



"Lights Out" - A must have for those times you go doorless. These clips hold in the button that turns your interior lights on. Sold as a pair. Installation is quick and requires no tools. Simply squeeze the spring while pressing in the door light switch. Place the spring over the switch and release the spring. The button is now securely locked in place during even the most extreme wheeling. Brilliant!

Door Light Spring Clip	Part #	Part #
Door Light Spring Clip, 97-06 Wrangler, Pair	11819.01	

Door Bracket

This stainless steel door bracket not only dresses up your door opening, but it will far outlast the original piece. Includes door striker pin.

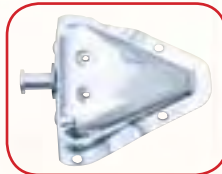

Door Bracket	Stainless
81-95 CJ/Wrangler, Pair	11810.05

Adjustable Door Straps

Keep those doors from swinging out too wide during wind storms on trail rides. Straps incorporate several "pockets" that allow for maximum adjustability. Each pack contains two straps.



Adjustable Door Straps	Part #
All Jeeps® CJ & Wrangler, Pair	12103.01

Half Door Inserts

Replaces factory hard Half Door Inserts. Available in three interior door matching colors. Sold individually or in sets of three.



Half Door Inserts 87-06 Wrangler	Black	Grey	Spice
Each	11818.01	11818.09	11818.37
3Pack	11819.15	11819.09	11819.37

Ultimate/Deluxe/Neoprene and Sport Grab Handles

Put easy to use Grab Handles wherever you need them. Constructed of tough nylon webbing with either a molded sure-grip handle (Ultimate), soft foam handle (Deluxe) or plain Nylon webbing (Sport). The Ultimate Grab Handles are available in two hot colors to accent the Jeeps® interior-Red & Black. Deluxe and Sport models fit all Jeep® roll bars and 3" roll cages with padding. Ultimate Grab Handles will fit 2" or 3" padded or un-padded roll bars. All designs are packed in pairs.



13305.02 Deluxe Grab Handle



13505.03 Ultimate Grab Handle



13305.01 Sport Grab Handle

Ultimate/Deluxe and Sport Handles, 55-10 CJ and Wrangler

	Part #
Ultimate Grab Handles, Pair -Red	13505.03
Ultimate Grab Handles, Pair -Black	13505.04
Deluxe Grab Handles, Pair	13305.02
Sport Grab Handles, Pair	13305.01
Neoprene Wrapped Deluxe Grab Handles, Passenger/Driver Side Roll Bar, Pair -Black	13305.30
Neoprene Wrapped Deluxe Grab Handles, Passenger/Driver Side Roll Bar, Pair -Red	13305.31



13505.04 Ultimate Grab Handle



13305.30 Neoprene Wrapped Deluxe Grab Handle

Grab Handles For 2007-10 Jeep® Wrangler

Three styles to choose from - Rear Side Grab Handles for easy entry and exit attach directly into factory mounting holes with your original hardware. They also double as Front Seat Grab Handles by easily attaching to the windshield pillar with supplied hardware. Rear Seat Grab Handles attach to the head rest of your JK front seats. Finally, we have developed a Neoprene Wrapped design for over driver and passenger that completes the entire JK package!

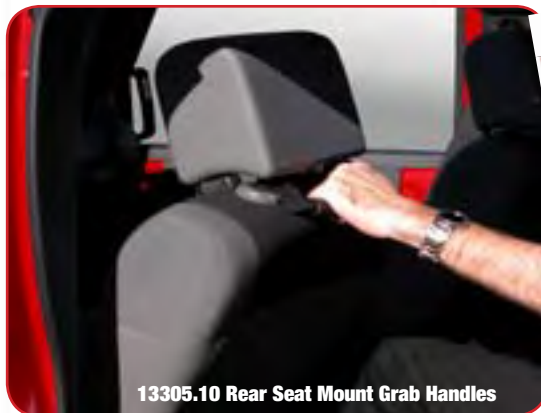

13305.10 Rear Seat Mount Grab Handles

13305.15 Rear Side/Windshield Pillar Grab Handles



Dual Application

13305.15 Rear Side Grab Handles



13305.14 Rear Side/Windshield Pillar Grab Handles



Grab Handles	Red	Black
07-10 Wrangler, Seat Mount Grab Handles, Pair	13305.11	13305.10
07-10 Wrangler Rear Side/Windshield Pillar Grab Handles, Pair	13305.15	13305.14

Rear Dual Grab Strap for Jeep®

Gives back seat passengers a place to hold on while on the trail. Constructed of durable nylon webbing with soft molded foam handles for ease of use and comfort. Easily attaches with hook and loop around the center roll bar or to factory mounts. No drilling required. Special side "pockets" create a handy spot for hanging clothes.

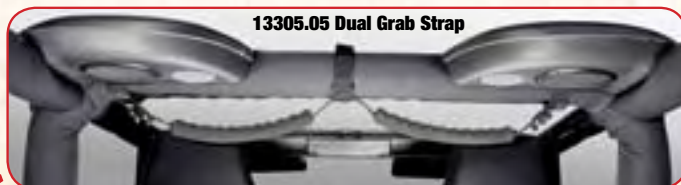

13305.05 Dual Grab Strap



13305.13 Center Roll Bar Dual Grab Handle

Rear Dual Grab Strap	Red	Black
07-10 Wrangler, Each	13305.13	13305.12
All 87-06 Wrangler/Unlimited, Each	-	13305.05

Trail Bags

Rugged Ridge has the answer for your onboard storage needs. These soft-side storage bags feature heavy canvas construction and oversized zippers. Great for carrying recovery gear, spare parts, camping gear, clothes, or any other necessity for a wheeling trip. Rugged nylon straps keep the bags in place during even the most insane wheeling. Make the most out of your roll cage with a full complement of Rugged Ridge storage bags. These bags are easy to install and take off and work with both hard tops and soft tops.



Trail Bags	Part #
Seat Back Trail Bag, Detachable, 76-10 CJ & Wrangler, Each	13551.25
Seat Back Trail Bag, 76-10 CJ & Wrangler, Each	13551.26
Sport Bar Trail Bag, Canvas Storage Bag, 92-06 Wrangler, 07-10 2-Door Wrangler, Each	11250.06
Sport Bar Trail Bag, Canvas Storage Bag, 04-06 Wrangler Unlimited, 07-10 Wrangler, Each	11250.07
Sport Bar Trail Tube Bag, 76-10 CJ & Wrangler, Each	11250.05

Trail Net Kits

Keep your stuff where you need it with Rugged Ridge Trail Nets. These elastic nets attach to the glove box & dash and door & console areas with screw in snap heads and give you more storage in areas that are otherwise unused. Some drilling required.



13551.20 Glove Box & Dash Trail Net Kit



13551.21 Door & Console Trail Net Kit

Trail Nets For 97-06 Wrangler	Part #
Door & Console Trail Net Kit, Each	13551.21
Glove Box & Dash Trail Net Kit, Each	13551.20

Flashlight Holders

Keep your flashlight where you know it will always be. Choose either the sport bar holder or the steel mounting brackets, which screw mount to any flat surface. Flashlight not included, but you knew that.



11205.20 Sportbar Flashlight Holder

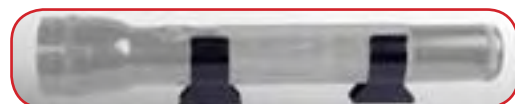

11238.06 Flashlight Mounting Brackets

Flashlight Holders	Part #
Sport Bar Flashlight Holder, 55-10 CJ & Wrangler, Each	11205.20
Mounting Brackets, for 1.5" Diameter Flashlights, Universal Application, drilling required, Pair	11238.06

Ultimate Roll Bar Coat Hanger

Makes hanging your coat or laundry easy. Attaches to the roll bar with two nylon straps.



13550.04 Ultimate Roll Bar Coat Hanger

Ultimate Roll Bar Coat Hanger	Part #
55-10 CJ & Wrangler, Pair	11250.04

Factory Style JK Mirrors for Wrangler



11002.13

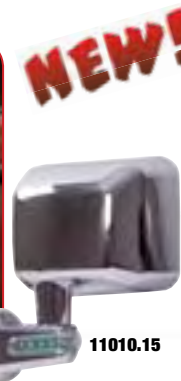

11010.15

NEW!

Factory Style Replacement Mirrors for JK

	Part #
07-10 Wrangler, Black, Passenger Side (NEW)	11002.12
07-10 Wrangler, Black, Driver Side (NEW)	11002.13
07-10 Wrangler, Black w LED Turn Signal Indicators, Passenger Side (NEW)	11002.14
07-10 Wrangler, Black w LED Turn Signal Indicators, Driver Side (NEW)	11002.15
07-10 Wrangler, Chrome, Passenger Side (NEW)	11010.12
07-10 Wrangler, Chrome, Driver Side (NEW)	11010.13
07-10 Wrangler, Chrome w LED Turn Signal Indicators, Passenger Side (NEW)	11010.14
07-10 Wrangler, Chrome w LED Turn Signal Indicators, Driver Side (NEW)	11010.15
07-10 Wrangler, Black, Kit, Pair (NEW)	11002.21
07-10 Wrangler, Black w LED Turn Signal Indicators, Kit, Pair (NEW)	11002.22
07-10 Wrangler, Chrome, Kit, Pair (NEW)	11010.11
07-10 Wrangler, Chrome w LED Turn Signal Indicators, Kit, Pair (NEW)	11010.16



11002.11 Replacement Mirror, 03-06 Wrangler, Driver Side

Factory Style Mirrors for 2003-06 Wrangler

Rugged Ridge offers the most complete line of replacement mirrors for Jeep® vehicles found anywhere. All replacement mirrors are replicas of the factory original so you maintain that original equipment look while upgrading or replacing those worn mirrors. Each replacement mirror uses only the finest materials ensuring a long life and ease of use. All replacement mirrors are offered in pairs or individually so you can replace one side or both depending on your needs.

Factory Style Replacement Mirrors

	Part #
03-06 Wrangler, Pair*	11002.09
03-06 Wrangler, Passenger Side*	11002.10
03-06 Wrangler, Drive Side*	11002.11

* including Unlimited Models. Will also fit 97-02 for an updated look.

Factory Style Mirrors for Wrangler

Wrangler mirrors are available in UV Treated black plastic, chrome plastic or polished Stainless Steel.

Factory Style Mirrors for 87-02 Wrangler w/Factory Half Doors & 94-02 Wrangler w/Factory Full Doors

	Stainless	Black	Chrome
Pair	11005.08	11002.03	11010.04
Driver Side	-	11002.05	11010.07
Passenger Side	-	11002.04	11010.06



11002.03 Side Mirrors, Black, 87-02 Wrangler



11005.08 Side Mirrors, Stainless, 87-02 Wrangler

Side Mirrors for Jeep® CJ

CJ Style mirrors are available in painted black steel, polished Chrome or polished Stainless Steel. Replacement components also are available.

Side Mirrors for Jeep® CJ	Stainless	Black	Chrome
55-86 CJ (Pair)	11005.01	11001.02	11010.01
55-86 CJ (Pair)*	11005.02	11001.03	-

* with Convex Mirror Glass for Passenger Side



11001.02 Side Mirrors, Black, 55-86 CJ



11005.01 Side Mirrors, Stainless, 55-86 Jeep® CJ

Jeep® CJ Style Mirrors for Wrangler/Willys

Only Rugged Ridge CJ Style Mirrors for Wranglers give you that "retro" look! Like original 5" round is a great upgrade for your Willys!

CJ Style Side Mirrors	Stainless	Black
87-95 Wrangler, CJ Style Mirror, Pair	11005.06	11001.07
97-06 Wrangler, CJ Style Mirror, Pair	11005.07	11001.08
41-64 Willys, Jeep® CJ, 5" Round Mirror, Pair	-	11001.01



11001.07 Side Mirrors, Black, 87-95 Wrangler

Rear View Mirrors

Rugged Ridge offers a complete line of replica rear view mirrors for vehicles dating back to 1941.

11020.01 Rear View Mirror, Black, 41-75 Jeep® CJ/ Willys



11020.0 Rear View Mirror, Black, 72-10 Jeep® CJ/Wrangler

Rear View Mirrors	Part #
72-10 Jeep® CJ & Wrangler, Each*	11020.02
41-75 Jeep® CJ, Each	11020.01
Mounting Glue, Each	11021.01

* Includes mounting glue button.

Bushings for Mirror Brackets



11029.03 Bushings (pair), Black Anodized, for Jeep® CJ Style Mirrors

11029.01 Bushing (each), Plastic, for Jeep® CJ Style mirrors

1955-86 CJ Mirror Bushings Part

Black Plastic, Each (need 2 per arm)	11029.01
Pair, Clear Anodized Aluminum, Each	11029.02
Pair, Black Anodized Aluminum, Each	11029.03

Rugged Ridge also offers a full line of Cherokee and Grand Cherokee mirror applications.



11016.01 LED Mirror Kit, Chrome, 87-02 Wrangler



11002.20 Heated Mirror Kit, Black, 87-02 Wrangler

LED Mirrors & Heated Mirrors

Looking to upgrade your current mirrors with the very latest features? Rugged Ridge offers a wide variety of special mirrors that offer you added features at economical prices. We offer heated mirrors, LED turn signal mirrors, Dual Focal Point mirrors and special mirror relocation brackets to place your mirrors on the vehicle if you remove your doors. Look to Rugged Ridge to offer the widest variety of replacement mirrors available for Jeep®. Special heating elements are incorporated into the mirror to quickly defrost your mirror during those cold winter days. The latest in mirror technology puts an LED light on the side of the mirror that turns on when you use your turn signal or parking lamps. This great feature lets the driver beside or behind you know you are turning. Mirrors available with heat, LED or BOTH! Some wiring and drilling required for installation.

LED Mirrors	Chrome	Black	LED Heated Mirrors	Black	Heated Mirrors	Black
87-02 Wrangler, Pair	11016.01	11015.01	87-02 Wrangler w/Half Doors, Pair	11015.20	87-02 Wrangler w/Half Doors, Pair	11002.20
87-02 Wrangler, Pair*	11016.02	11015.02	94-02 Wrangler w/Full Doors, Pair	11015.20	94-02 Wrangler w/Full Doors, Pair	11002.20

* with Dual Focal Point on Passenger Side Lens

Dual Focal Point Mirrors

This special convex glass mirror gives you extra side visibility with dual focal points: one regular mirror view on the upper half of the mirror and a convex "items are closer than they appear" view on the bottom of the mirror. No more need for those clumsy "pancake" convex mirrors that keep on falling off in car washes!

Dual Focal Point Mirrors	Chrome	Black
87-02 Wrangler w/Half Doors, Pair	11018.01	11017.01
94-02 Wrangler w/Full Doors, Pair	11018.01	11017.01



Mirror Relocation Brackets

Custom designed brackets bolt into existing holes on the windshield relocating your mirrors off the door. The perfect add-on accessory for those off-road adventures where you do not want your doors. Each bracket kit for the 2007-10 Wrangler comes with a special paintable filler plate to cover up the hole created when you remove your mirrors. Sold in pairs.



11026.02, 97-02 Wrangler



11025.03, 03-06 Wrangler



11025.02, 97-02 Wrangler



11025.04, 07-10 Wrangler

Mirror Relocation Brackets	Stainless	Black
07-10 Wrangler w/Filler Plate, Pair	11026.04	11025.04
03-06 Wrangler, Pair	11026.03	11025.03
97-02 Wrangler w/Half or Full Doors, Pair	11026.02	11025.02
87-95 Wrangler w/Half Doors, Pair	11026.01	11025.01
94-95 Wrangler w/Full Doors, Pair	11026.01	11025.01

Get the ultimate WOW factor with Rugged Ridge polished stainless steel accessories! These beautiful bolt on accessories turn even the most worn Jeep® into a hot street machine. Constructed of prime 304 stainless steel that has been polished to a mirror finish, these accessories are built to last. 304 stainless steel is virtually rust proof guaranteeing that these parts will stand the test of time. All hardware is also constructed of stainless steel so the polished look you are going for is complete. Rugged Ridge offers the most complete line of stainless accessories so you can truly customize the look of your vehicle. When you want the best, look to Rugged Ridge Stainless Accessories!

Stainless Steel Hood Kits

11101.04 Hood Kit, 07-10 Wrangler

11101.03 Hood Kit, 98-06 Wrangler

11101.01 Hood Kit, 76-95 CJ & Wrangler

Rugged Ridge

Hood Kit, Stainless	Part #
07-10 Wrangler, 7 pc. Kit	11101.04
98-06 Wrangler, 8 pc. Kit	11101.03
97 Wrangler, 8 pc. Kit	11101.02
76-95 CJ & Wrangler, 9 pc. Kit *	11101.01

* 1976-95 models include hood catch

Windshield Tie Down Kits

11104.01 Windshield Tie Down Kit, 97-06 Wrangler

11101.05 Windshield Tie Down Kit, 07-10 Wrangler

Windshield Tie Down Kit, Stainless	Part #
07-10 Wrangler, Kit (Footman loop, windshield bumper covers, washer cover)	11101.05
97-06 Wrangler, Kit (Footman loop, windshield bumper covers)	11104.01
55-95 CJ/Wrangler, Kit (2 Footman loops, 2 windshield tie down hoops)	11104.02

Footman Loops

11105.03 Long Footman Loop

Footman Loop, Stainless	Part #
87-95 Wrangler, Long, Each	11105.03
55-95 CJ/Wrangler, Short, Each	11105.02
55-95 CJ/Wrangler, Short & Long, Pair	11105.01

Hood Catches

Available in polished 304 Stainless Steel or Chrome, these catches will keep your Jeep's® hood in place regardless of how rough the ride gets!

11116.02 Hood Catch, 97-06 Wrangler

11116.05 Hood Catch, 42-95 CJ & Wrangler

11116.01 Hood Catch, 42-95 CJ & Wrangler

11116.06 Hood Catch, 07-10 Wrangler

11302.03 Locking Hood Catch, Chrome, 97-06 Wrangler

Hood Catch, Stainless	Part #	Locking Hood Catch, Chrome	Part #
07-10 Wrangler, Pair (Cast Stainless)	11116.06	97-06 Wrangler	11302.03
97-06 Wrangler, Pair (Cast Stainless)	11116.02		
42-95 CJ/Wrangler, Pair (Cast Stainless)	11116.05		
42-95 CJ/Wrangler, Pair (Plated Stainless)	11116.01		

Stainless Hinge Treatments for 2007-10 Wrangler



These cast stainless design Hinge Treatments are guaranteed not to rust while providing a new beefy look. Door and Hood Hinge covers feature a easy-to-install design. Replacing your existing hinges can break & crack the surrounding paint, as the hinges were painted at the factory after installation. These covers retain the stock hinge but give it a new look without harming your expensive paint. A direct bolt on - no drilling required, fits either side. Use #11113.06 for 4-door models, #11113.05 for 2-door models and #11111.10 for hood.

Fast and easy installation on your door or hood hinges

Hinge Treatment	Stainless
07-10 Wrangler, Pair	11111.10
07-10 Wrangler 4-Door Kit, 8 Hinges	11113.06

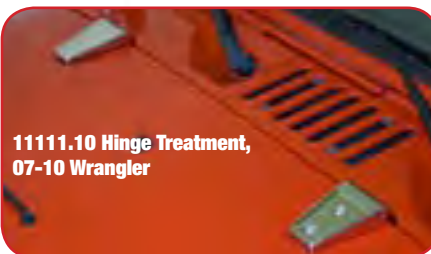

11111.10 Hinge Treatment, 07-10 Wrangler



11111.10 Hinge Treatment Can Be Used on Door or Hood

Stainless Hinges for 2007-10 Wrangler

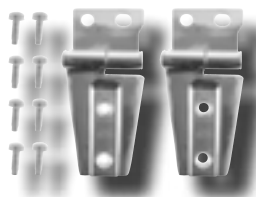

11111.22

Solid stainless steel can't be beat for longevity and that's why Rugged Ridge now offers stainless steel hinges for the 07-10 Wrangler. These hinges are a direct bolt-on replacement for the stock units. Installation is easy with only simple hand tools. Both door and hood hinge sets are available for a complete vehicle makeover. Includes matching stainless steel hardware.

Stainless Steel Hinges for 07-10 Wrangler	Part #
Door Hinge Kit, 07-10 Wrangler 2-Door, 4 Hinges	11111.20
Door Hinge Kit, 07-10 Wrangler 4-Door, 8 Hinges	11111.21
Hood Hinge Kit, 07-10 Wrangler, Pair	11111.22

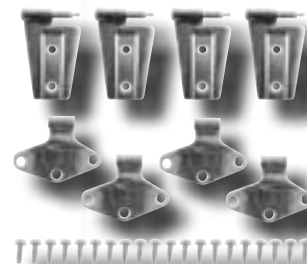

11111.21

Stainless Steel Hinges/Brackets

11112.03 Windshield Bracket, 07-10 Wrangler



11112.02 Windshield Hinges, 97-06 Wrangler

These hinges and brackets are one of those pieces that really shows off an attention to detail. They install quickly and easily and add a little bit of flash. Sold as a matching left/right hand pair. Includes all necessary hardware.

Stainless Windshield Hinges	Part #
07-10 Wrangler, Pair - Bracket	11112.03
97-06 Wrangler, Pair - Hinge	11112.02
76-95 CJ/Wrangler, Pair - Hinge	11112.01
Hood Hinges, Stainless	Part #
97-06 Wrangler, Pair	11111.02
76-95 CJ/Wrangler, Pair	11111.01
Stainless Door Hinges	Part #
76-93 CJ/Wrangler w/Full Doors, 4 pc.	11113.01
87-06 Wrangler w/Half Doors, 97-06 w/Full Doors, 4 pc.	11113.02
94-95 Wrangler w/Full Steel Doors, 4 pc.	11113.03
Stainless Lower Door Hinge	Part #
76-06 Wrangler, All, Pair	11113.04



11111.02 Hood Hinge, 97-06 Wrangler



11113.02-Door Hinges, 87-06 Wrangler

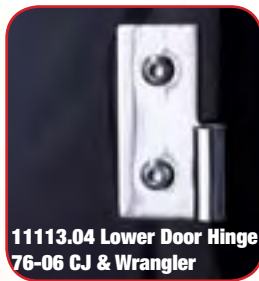

11113.04 Lower Door Hinge 76-06 CJ & Wrangler

Hood Treatments



11117.05



11117.04



11352.11

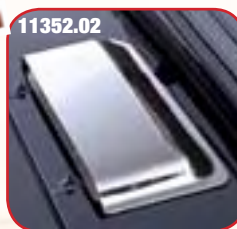

11352.02



11130.01

Hood Vent Cover, Stainless	Part #
07-10 Wrangler, Each	11117.05
98-06 Wrangler, Each	11117.04
97 Wrangler, Each	11117.03
76-95 CJ/Wrangler, Each	11117.02
55-75 CJ, Each	11117.01

11130.02



Air Scoop	Part #
98-10 Wrangler, Chrome, Each	11352.11
87-95 Wrangler, Chrome, Each	11352.02
98-06 Wrangler, Stainless, Each	11130.02
78-95 CJ/Wrangler, Stainless, Each	11130.01

Note: Air Scoops can be mounted with opening facing either front or rear.

Mirror Relocation Brackets



Custom designed brackets bolt into existing holes on the windshield, relocating your mirrors off the door. The perfect add-on accessory for those off-road adventures where you do not want your doors. The 2007-10 Wrangler bracket kit comes with a Stainless filler plate to cover up the holes created when you remove your mirrors.

11026.03 Mirror Relocation Brackets, 03-06 Wrangler

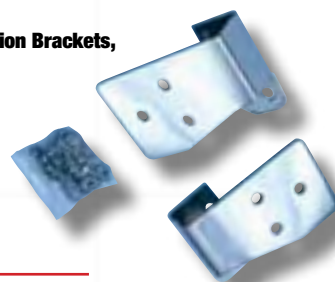

Stainless Mirror Relocation Brackets (Pair)	Part #
07-10 Wrangler w/Filler Plate	11026.04
03-06 Wrangler w/Half or Full Doors	11026.03
97-02 Wrangler w/Half or Full Doors	11026.02
87-95 Wrangler w/Half Doors & 94-95 Wrangler w/Full Doors	11026.01



Windshield Light Brackets

Easily and quickly mounts to your factory windshield hinge creating two great spots for off-road lighting. Foam backing protects your vehicle's finish. No drilling required for installation. Sold in pairs with all mounting hardware.

11028.03 Windshield Brackets, 07-10 Wrangler

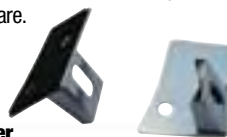

Stainless Windshield Light Brackets (Pair)	Part #
07-10 Wrangler	11028.03
97-06 Wrangler	11028.02
76-95 CJ/Wrangler	11028.01



Door Handle Covers/Recess Guards

Compliments Your Exterior Stainless Accessories

Give your Jeep® a great new custom chrome look in just a few minutes! Made from chrome plated ABS plastic, these exterior trim pieces are designed to resist flaking and oxidation. Easy no drill installation! They install in seconds using pre-applied double-sided tape. Buy the Recess Guard and door handle kits for the ultimate look!

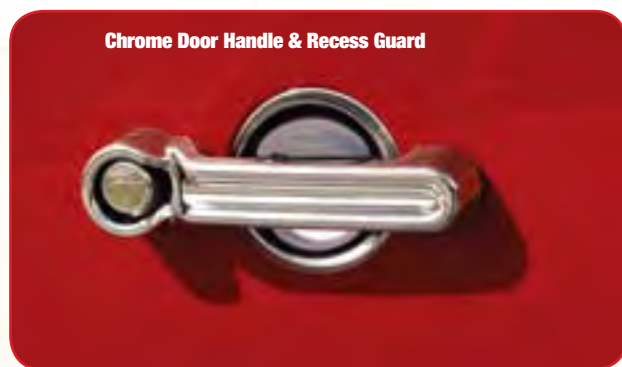

Chrome Door Handle Covers, 2-Door, 07-10 Wrangler, 3 Pc. Kit	13311.11
Chrome Door Handle Covers, 4-Door, 07-10 Wrangler, 5 Pc. Kit	13311.12
Chrome Door Handle Recess Guards, 2-Door, 07-10 Wrangler, 3 Pc. Kit	13311.15
Chrome Door Handle Recess Guards, 4-Door, 07-10 Wrangler, 5 Pc. Kit	13311.16
Chrome Door Handle Covers & Recess Guard Kit, 2-Door, 07-10 Wrangler, 6 Pc. Kit	13311.17
Chrome Door Handle Covers & Recess Guard Kit, 4-Door, 07-10 Wrangler, 10 Pc. Kit	13311.18
Black Door Handle Recess Guards, 2-Door, 07-10 Wrangler, 3 Pc. Kit	11651.25
Black Door Handle Recess Guards, 4-Door, 07-10 Wrangler, 5 Pc. Kit	11651.26

Stainless & Billet Style Gas Hatch Covers

Create a custom look in just a few minutes. This special design fits directly over the existing gas cap opening. These tough gas covers are available in either stamped stainless steel, polished aluminum or chromed aluminum and are specially treated for resistance to gasoline and other chemicals. Unlike other designs on the market, installation does not require the removal of the tail light or internal gas cover components. For 2007-10 Wranglers the cover attaches directly to the original equipment plastic insert using self tapping screws with no need to remove the existing plastic insert. Available with or without locking mechanism. Please note that your factory gas cap is still required.

11134.01 Gas Cover, Stainless 97-06 Wrangler



11134.03 Locking Gas Cover, Stainless 07-10 Wrangler

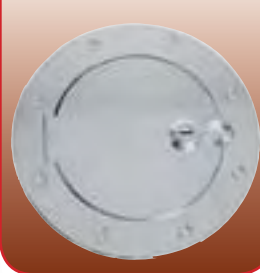

11425.01 Gas Cover, Polished Aluminum, 97-06 Wrangler



Gas Filler Housing



This stainless steel or chromed plastic gas filler housing will add a dash of class to your Jeep®. This is a direct replacement so no drilling is required.

11135.25 Chromed Plastic, 97-06 Wrangler

Gas Filler Housing	Chromed Plastic	Stainless
97-06 Wrangler	11135.25	11135.02
76-95 CJ/Wrangler	-	- 11135.01



11425.04 Gas Cover, Chromed Aluminum 07-10 Wrangler

Application	Finish	Part #
07-10 Wrangler, Each	Stainless Steel, Locking	11134.03
07-10 Wrangler, Each	Stainless Steel	11134.02
07-10 Wrangler, Each	Chromed Aluminum	11425.03
07-10 Wrangler, Each	Chromed Aluminum, Locking	11425.04
97-06 Wrangler, Each	Stainless Steel, Locking	11134.04
97-06 Wrangler, Each	Stainless Steel	11134.01
97-06 Wrangler, Each	Polished Aluminum	11425.01
97-06 Wrangler, Each	Polished Aluminum, Locking	11425.07

11134.04 Gas Cover, Stainless, 97-06 Wrangler



Front Euro-Guards



11142.04, 11142.11, 11142.12



11142.01, 11142.02

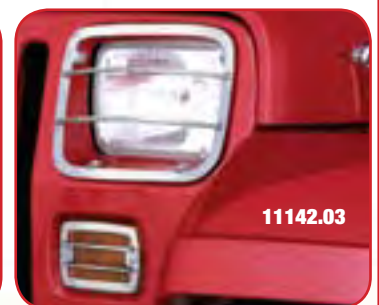

11142.03

Protect those expensive headlights, turn signals and parking lights from impact with the Rugged Ridge Euro Light Guards. Each Euro Light Guard is easy to install with no drilling required. They are of polished stainless steel for a true attention to detail.



Front Euro-Guards	Part #
07-10 Wrangler, Headlight Guards, Pair	11142.04
07-10 Wrangler, Turn Signal Guards, Pair	11142.11
07-10 Wrangler, Side Flare Light Guards, Pair	11142.12
07-10 Wrangler, Fog Light Guards, Pair	11142.13
97-06 Wrangler, Headlight Guards, Pair	11142.01
98-06 Wrangler, Turn Signal & Side Flare Light Guard Kit, 4 pc.	11142.02
87-95 Wrangler, Head Light & Turn Signal Guard Kit, 4 pc.	11142.03

Billet and Regular Stone Guard Kits



11102.03



11102.04

Protect and enhance the look of your Jeep® with your choice of two types of stone guards. Each set includes six pieces to protect your headlights, taillights and turn signal indicators. Match these kits up with the Rugged Ridge Grill inserts and headlight bezels and you have a complete front end enhancement.

Stone Guard Kits	Part #
97-06 Wrangler, 6 pc. Kit	11102.03
87-95 Wrangler, 6 pc. Kit	11102.02
72-86 Wrangler, 6 pc. Kit	11102.01
Billet Stone Guard Kits	
97-06 Wrangler, 6 pc. Kit	11102.05
87-95 Wrangler, 6 pc. Kit	11102.04

Rear Euro-Guards



11103.03 Rear Euro Guard, 07-10 Wrangler



11103.01 Rear Euro Guards, 76-06 CJ/Wrangler



11103.21 Rear Euro Guards, 05-08 Grand Cherokee

Protect and upgrade the look of your Jeep® with a set of Rugged Ridge Euro Taillight Guards. Each Rear Euro Taillight Guard is easy to install with no drilling required. On 1976-06 models, just remove your taillight, slip on the Euro Guard and replace the taillight. Constructed of durable powder coated steel or polished stainless steel for long life and great looks. Rubber inserts around the mounting screws on 2007-10 models keep the metal Euro Guard off the taillight, preventing scratching and rattles.

Rear Euro Guards

Part

07-10 Wrangler, Pair	11103.03
76-06 CJ/Wrangler, Pair	11103.01
99-04 Grand Cherokee, Pair	11103.20
05-08 Grand Cherokee, Pair	11103.21

Tail Gate Hinges



11114.02 Tailgate Hinges, Stainless, 87-95 Wrangler

These tailgate hinges are made from prime 304 stainless steel and polished to a mirror finish. They are a direct replacement for the weak, bland stock pieces. Includes all necessary hardware.

Stainless Tailgate Hinges

Part #	Part #
97-06 Wrangler, Pair	11114.03
87-95 Wrangler, Pair	11114.02
76-86 CJ, Pair*	11114.01

*Lower Tailgate Hinges

Tire Stop



Replace your bent or rusted tire stop with a brand new Rugged Ridge factory style replacement tire stop. Protect your taillight from your spare tire when opening the tailgate of your Jeep®.

Stainless Tire Stop

Part

76-95 CJ / Wrangler	11140.01
---------------------	----------

Body Corner Guards

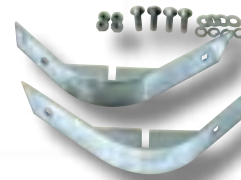

Body Guard Short Rear Corner

Stainless

1987-95 Wrangler	11110.01
------------------	----------

Side Steps



Side Steps

Stainless

76-86 CJ	11139.01
----------	----------

Radiator Bug Shields

Protect your front grille from bugs and debris with these durable Radiator Bug Shields by Rugged Ridge. All shields are bound by soft rubber to prevent vehicle scratching. Installation requires some drilling.



11106.03 Radiator Bug Shield, Stainless, 97-06 Wrangler

Radiator Bug Shields

Part

97-06 Wrangler	11106.03
87-95 Wrangler	11106.02
55-86 CJ	11106.01

Bumperettes



11108.01 Bumperettes

Complete the look of your classic Jeep® with these Bumperettes. Classic bumperettes have been a part of the signature Jeep® styling for decades. Constructed of polished 304 stainless steel for long life. Bumperettes will protect your vehicle from those minor bumps and spring back for more. Sold as a pair. Includes mounting hardware.

Stainless Bumperettes

Part

76-06 CJ/ Wrangler*	11108.01
---------------------	----------

* including Wrangler Unlimited

CJ Hard Top Hinges



Hinges

Stainless

76-86 CJ, Pair	11115.01
----------------	----------

Got a CJ with a hard top? Dress it up with these Rugged Ridge Stainless Hinges constructed of prime 304 stainless steel. Includes mounting hardware.

Brake Dust Shields



If you're tired of constantly cleaning your expensive custom wheels from brake dust, these caliper dust covers will do the trick. The covers come in pairs and are made of stainless steel for maximum rust protection.

11121.01 Brake Dust Shields

Brake Dust Shields	Stainless
79-86 CJ with 2 bolt caliper plate, Pair	11121.02
77-78 CJ with 6 bolt caliper plate, Pair	11121.01

Rocker Panels



Made of highly polished stainless steel, these rocker panels extend from the front fender to the back fender. No drilling is required.

Rocker Panel	Part #
97-06 Wrangler, Pair	11145.02
87-95 Wrangler, Pair	11145.01

Battery Tray



Battery trays take a beating. Replace yours with this stainless steel design from Rugged Ridge. Mounts to factory mounting holes for ease of installation.

Battery Tray	Stainless
76-86 CJ, Each	11132.01

Door Retainer Channels



These half door retainer channels are the perfect way to give a finished look to half doors.

Stainless Half Door Retainer Channels	Part #
87-95 Wrangler, Pair	11146.01

Tow Hooks

11303.02



11303.01

Tow Hooks	Part #
42-06 CJ/Wrangler, Front, Stainless, Each	11141.01
97-06 Wrangler, Front, Chrome, Pair	11303.01
97-06 Wrangler, Rear, Chrome, Pair	11303.02
42-06 CJ/Wrangler, Front, Chrome, Each	11303.03

11303.03

Full Frame Light Bar



This 3-piece light bar makes installing lights a breeze, just install one piece at a time. The stainless steel construction not only looks good, but stands up to the elements.

Stainless Full Frame Light Bar (Each)	Part #
97-06 Wrangler	11138.01

License Plate Bracket

Replace that worn and rusted license plate bracket with a new stainless one that will last for years.



11136.01

Stainless License Plate Bracket	Part #
76-86 CJ, Each	11136.01
87-95 Wrangler, Each	11136.02

Antenna Base Cover

This chromed plastic antenna base cover is a quick and easy way to add a touch of flash to your 07-10 Wrangler. Simply unscrew your factory antenna and place the cover over the factory antenna base. Installation is easy thanks to the pre-attached durable double sided tape.



Antenna Base Cover	Part #
07-10 Wrangler, Each	13311.26
CJ/YJ Wrangler, Each	17213.01

Stainless Antenna

The details make all the difference when it comes to building a unique vehicle. This stainless steel antenna mast is just the kind of touch that will set you apart from the crowd. Antenna only, base not included.



Stainless Antenna	Part #
97-06 Wrangler	11131.01

11131.01

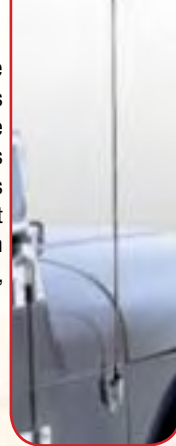

Mirror & Mirror Arm Covers

JK



13311.02 Mirror Arm Cover



13311.01 Mirror Cover



13311.03 Mirror Cover Kit

Give your JK Wrangler a unique look with these mirror and arm covers. Available in pairs as mirror covers, just the arms or a kit for both. Made from chrome plated ABS plastic, these pieces are an easy install, using pre-applied double-sided tape.

Mirror Covers, Chrome, 07-10 Wrangler, Pair	13311.01
Mirror Arm Covers, Chrome, 07-10 Wrangler, Pair	13311.02
Mirror Cover Kit, Chrome, 07-10 Wrangler, 4 Piece Kit	13311.03

Door Handle Covers/Recess Guards

Give your Jeep® a great new custom chrome look in just a few minutes! Made from chrome plated ABS plastic, these exterior trim pieces are designed to resist flaking and oxidation. Easy no drill installation! They install in seconds using pre-applied double-sided tape. The Door Recess Guards are designed to enhance the look of your Jeep while providing paint protection. Buy the Recess Guard and door handle kits for the ultimate look!

Chrome Door Handle & Recess Guard



Chrome Door Handle Cover

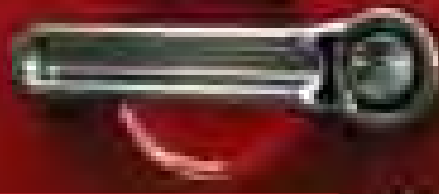

Chrome Recess Guard, Factory Door Handle



Black Recess Guard, Factory Door Handle

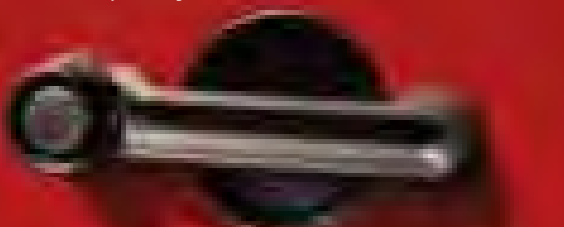

JK

Chrome Door Handle Cover



Chrome Door Handle Covers, 2-Door, 07-10 Wrangler, 3 Pc. Kit	13311.11
Chrome Door Handle Covers, 4-Door, 07-10 Wrangler, 5 Pc. Kit	13311.12
Chrome Door Handle Recess Guards, 2-Door, 07-10 Wrangler, 3 Pc. Kit	13311.15
Chrome Door Handle Recess Guards, 4-Door, 07-10 Wrangler, 5 Pc. Kit	13311.16
Black Door Handle Recess Guards, 2-Door, 07-10 Wrangler, 3 Pc. Kit	11651.25
Black Door Handle Recess Guards, 4-Door, 07-10 Wrangler, 5 Pc. Kit	11651.26
Chrome Door Handle Covers & Recess Guard Kit, 2-Door, 07-10 Wrangler, 6 Pc. Kit	13311.17
Chrome Door Handle Covers & Recess Guard Kit, 4-Door, 07-10 Wrangler, 10 Pc. Kit	13311.18

Wrangler Hood Scoops- NEW Design

Constructed of durable ABS plastic in 3 different finishes, these great looking Hood Scoops give your Jeep® an aggressive look! Each Hood Scoop has been designed to complement the lines of the Jeep® while enhancing airflow. Choose from three finishes; Smoke, polished chrome or textured black. Each attaches with tough automotive grade tape to ensuring a long life. Each scoop can be used with the opening facing the window or facing the front of the Jeep®, depending on your preference.

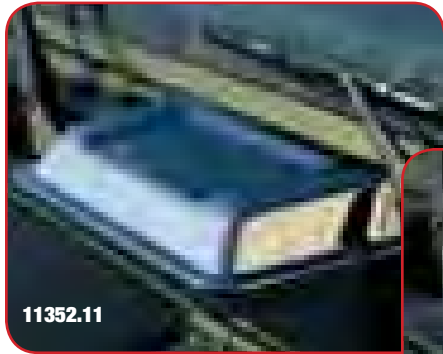

11352.11



11352.10



11352.12

Air Scoop

Part

07-10 Wrangler, Chrome, Each	11352.11
07-10 Wrangler, Smoked, Each	11352.10
07-10 Wrangler, Black, Each	11352.12
98-06 Wrangler, Chrome, Each	11352.11
98-06 Wrangler, Smoked, Each	11352.10
98-06 Wrangler, Black, Each	11352.12



Complete The Look!

Complete the look of your new Wrangler with these chrome accessories from Rugged Ridge. These UV-treated chromed plastic accents attach to your vehicle with durable double sided tape; the same tape used in attaching complete body kits to vehicles!

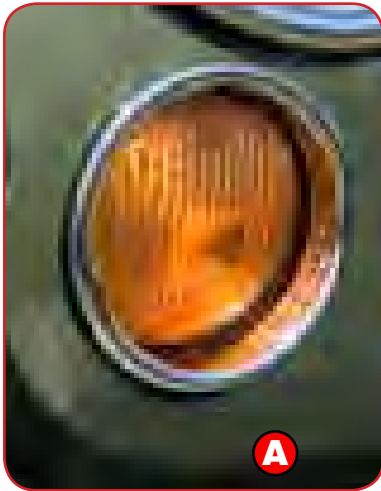

A



B



C



D



E



F

Exterior Accessories for 2007-10 Wrangler, 2 and 4-Door

Part

A Turn Signal Light Trim, Chrome, 07-10 Wrangler, Pair	13311.22
B Headlight Trim, Chrome, 07-10 Wrangler, Pair	13311.20
C Fuel Filler Accent Trim, Chrome, 07-10 Wrangler	13311.23
D Tail Light Covers, Chrome, 07-10 Wrangler	13311.21
E Tailgate Hinge Covers, Chrome, 07-10 Wrangler	13311.24
F Lift Gate Hinge Covers, Chrome, 07-10 Wrangler, w/Hardtop	13311.25

Windshield Brackets and Knobs

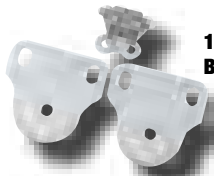

11127.01 Interior Windshield Bracket, Stainless, 76-86 Jeep® CJ

Sold as a pair. Includes mounting hardware.

Interior Windshield Brackets	Stainless	Black
76-95 CJ & Wrangler, Pair	11127.01	11208.01

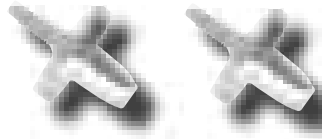

11304.01 Windshield Knob Chrome Plated Steel, 76-86 Jeep® CJ

These threaded knobs are an important part of the windshield hinge mechanism. Why not add some flash to their functionality?

Windshield Bracket Knobs	Chrome Plated Steel	Black*
76-86 CJ, Pair	11304.01	-
76-86 CJ, Each	-	13318.01

* Black knobs come as each. Please order 2 if you need a pair.

Steering Column Covers

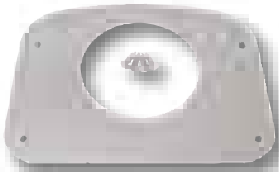

11128.01 Steering Column Cover, 76-86 Jeep® CJ

This cover attaches to the dash and dresses up an otherwise boring area of the interior. Includes mounting hardware.



Steering Column Cover	Stainless	Chromed Plastic
76-86 CJ, Each	11128.01	18090.01

Grab Handle and Glove Box

Grab Bar	Stainless	Black
55-86 CJ, Each	11123.01	11203.01



11123.01 Grab Bar, Stainless, 55-86 Jeep® CJ

This grab bar bolts to the dash. Includes mounting hardware.

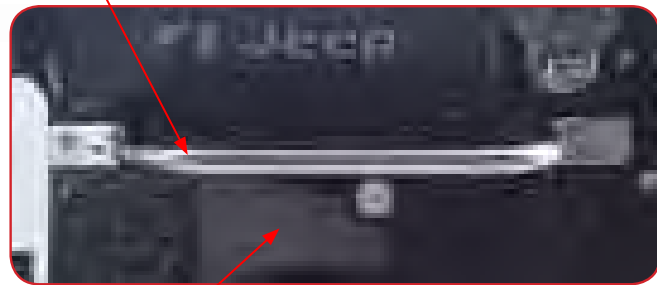

Gauge Covers

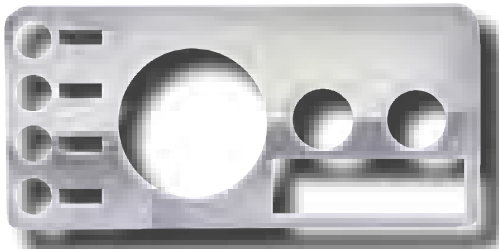

11124.01 Gauge Cover, Stainless, 76-86 Jeep® CJ

Frame your gauges in a more attractive way with this easy to install gauge cover. Available in stainless steel or black, it's sure to dress up the interior of your CJ!

Gauge Cover	Stainless	Black
76-86 CJ, Each	11124.01	11204.01

11228.01 Glove Box Door, Black, 76-86 Jeep® CJ



11813.11

11225.01 Glove Box Door, Stainless, 76-86 Jeep® CJ

13317.01

Make the interior of your Jeep® as unique as the exterior! Add a stainless glove box door. Or has your old glove box door or button just seen too much action? Replace either or both with brand new replacements. Doors available in either black or stainless.

Glove Box Door	Stainless	Black
76-86 CJ, Each	11125.01	11228.01

Wiper Motor Cover



11122.01 Wiper Motor Cover

Wiper Motor Cover, Stainless	Part #
76-86 CJ, Each	11122.02
68-75 CJ, Each	11122.01

Glove Box Parts	Steel
72-86 CJ Glove Box Button	11813.11
72-86 CJ Glove Box Bracket	13317.01

Dash Overlay

Beautiful brushed stainless finish enhances the look of your 87-95 Jeep® Wrangler. This beautiful cover attaches with double sided tape and screws. Multiple piece design makes installation a snap.

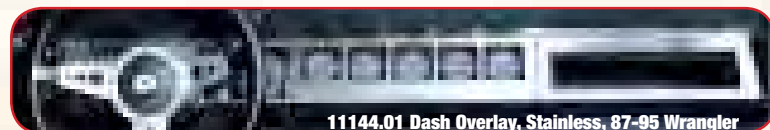

11144.01 Dash Overlay, Stainless, 87-95 Wrangler

Stainless Dash Overlay	Part #
87-95 Wrangler, 3 Pieces	11144.01

Hood Scoops



11352.01 Hood Scoop, Smoke



11352.12 Hood Scoop, Black

Increase the efficiency of your heater and air conditioner with these easy to install Hood Scoops. Available in UV treated chrome plastic, black UV treated plastic or durable smoked acrylic for long life and matching good looks. Ram Induction hood scoop is designed to provide maximum air flow to your passenger compartment. Installation is easy with double sided automotive grade tape. No drilling required. Mounts facing either direction.

Hood Scoops	Smoke	Chrome	Black
07-10 Wrangler	11352.10	11352.11	11352.12
98-06 Wrangler	11352.10	11352.11	11352.12
78-95 CJ & Wrangler,	13307.01	-	-
87-06 Wrangler *	11352.01	11352.02	-

* Universal Design



11354.02 Taillight Guards



11354.01 Taillight Black-outs

Taillight Guards

Complete the great look of your Jeep® with these easy to install Taillight Guards. Available in two styles; plain smoke blackout style and grille types for your choice of look. All are easy to install with double sided automotive grade tape. Note: Always take off the blackout style covers when driving at night. Blackout style headlight covers are designed for offroad use only.

Taillight Guards	Smoke	Chrome
76-06 CJ / Wrangler	11354.02	11354.03
Taillight Black-Outs		
76-06 CJ/Wrangler	11354.01	-

Wraparound Bug Deflector



Protect your windshield and hood from flying debris and bugs with this durable Bug Deflector from Rugged Ridge. Constructed of durable shatter resistant smoked acrylic, this bug shield is designed to last the test of time. Installation is easy using tough tape and under hood screw attachments (some drilling required).

Wraparound Bug Deflector	Part #
87-06 Wrangler, Smoke	11350.01

Headlight & Turn Signal Light Covers

Headlight & Turn Signal Light Covers, Smoke	Part #
97-06 Wrangler	11353.02

Get that cool blackout look while protecting your Jeep® from flying rocks and debris with these great looking Headlight and Turn Signal covers. Constructed of durable shatter resistant smoked acrylic, these tough covers can take quite a beating. Easy on-off attachment make these covers a snap to use. Note: Always take off these covers when driving at night. For offroad use only.

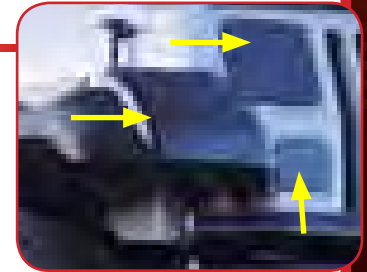

Molded Fender Guards

Enhance and protect your front fenders with these easy to use Fender Guards. Constructed of durable shatter resistant smoked acrylic, these guards are designed to protect your fenders from rock chips and bugs while providing a great look. Easy to install with tough double sided automotive grade tape, there is no drilling required to install. Note: Will not fit Renegade models.

Molded Fender Guards	Part #
97-06 Wrangler, Smoke	11351.02
87-95 Wrangler, Smoke	11351.01

LED Tail Lights For 1946-75 CJ and 1976-06 CJ & Wrangler

NEW!

Replace your dim factory tail lights with our brilliant LED tail light assemblies and get noticed! Rugged Ridge LED Tail Lights are DOT & SAE approved direct bolt in replacement tail lights, complete with impact resistant acrylic lenses, waterproof connections and polycarbonate housings. 1976-06 models feature 16 large brake, parking and directional LED's, 4 license plate light LED's and 22 brilliant white Back-Up LED's. While our 1946-75 units feature 9 large brake, parking and directional LED's, and 4 license plate light LED's. Our lights are Federal Regulation FMVSS108 compliant.

LED Tail Lights for 1945-06 CJ & Wrangler	Part #
LED Tail Light, LH, 76-06 Wrangler (NEW)	12403.83
LED Tail Light, RH, 76-06 Wrangler (NEW)	12403.82
LED Tail Light Pair, LH & RH, 76-06 Wrangler (NEW)	12403.85
LED Tail Light, LH, 46-75 CJ (NEW)	12403.81
LED Tail Light, RH, 46-75 CJ (NEW)	12403.80
LED Tail Light Pair, LH & RH, 46-75 CJ (NEW)	12403.84



12403.83 for 1976-06 CJ/Wrangler Has 20 Large LED's



12403.81 for 1946-75 CJ Has 13 Large LED's

All Circuitry Is Weather Resistant

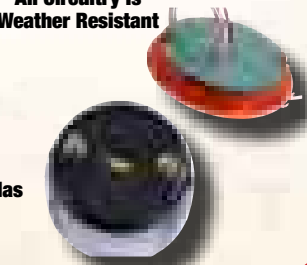

Waterproof Connections

Chromed Plastic Accessories For Your Grand Cherokee and Liberty.

Complete the look of your rig with chrome accessories from Rugged Ridge. These UV-treated chromed plastic covers attach to your vehicle with durable double sided tape; the same tape used in attaching complete body kits to vehicles! Available in easy to use kits for upgrading your Grand Cherokee and Liberty.



13310.10
Headlight Trim Covers, Chrome, 1999-04 Grand Cherokee



13310.37
Grille Inserts, Chrome, 2002-04 Liberty



13310.30
Headlight Trim, Chrome, 2002-04 Liberty

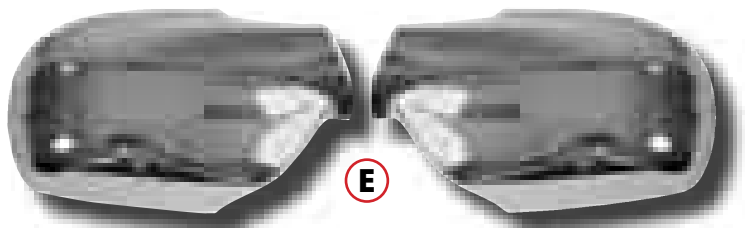

13310.22
Side Mirror Covers, Chrome, 2005-07 Grand Cherokee



13310.13
Door Handle Covers, Chrome, 1999-04 Grand Cherokee

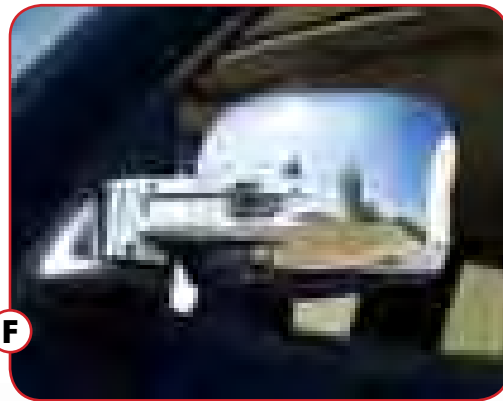

13310.32
Side Mirror Covers, Chrome, 2002-04 Liberty

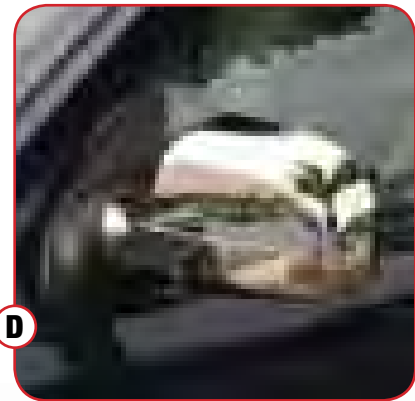

13310.12
Side Mirror Covers, Chrome, 1999-04 Grand Cherokee



13310.33
Door Handle Covers, Chrome, 2002-04 Liberty



13310.15
Fuel Door Cover, Chrome, 1999-04 Grand Cherokee



13310.25
Fuel Door Cover, Chrome, 2005-07 Grand Cherokee



K

13310.17
Pillar Trim, Chrome,
1999-04 Grand Cherokee



L

13310.14
Lift Gate Hinge Covers, Chrome,
1999-04 Grand Cherokee



P

13310.31
Tail Light Covers, Chrome,
2002-04 Liberty

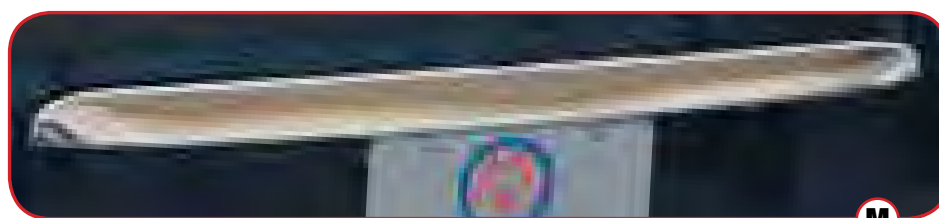

M

13310.16
Lift Gate Accent Trim, Chrome, 1999-04 Grand Cherokee

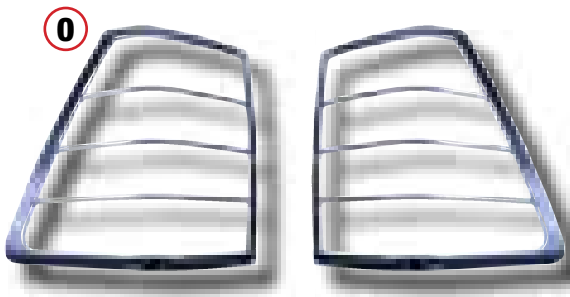

O

13310.21
Tail Light Covers, Chrome,
2005-07 Grand Cherokee

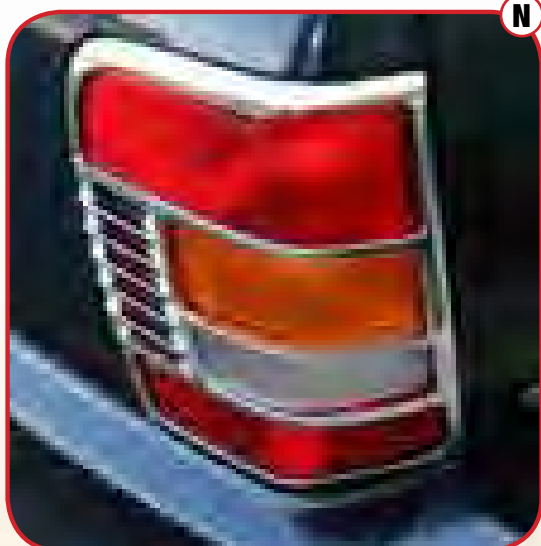

N

13310.11
Tail Light Trim Covers, Chrome,
1999-04 Grand Cherokee

Chrome Accessories for Jeep®

Part #

		Part #
A	Headlight Trim Covers, Chrome, 99-04 Grand Cherokee, Pair	13310.10
B	Headlight Trim, Chrome, 02-04 Liberty, Pair	13310.30
C	Grille Inserts Chrome, 7 Piece Kit, 02-04 Liberty	13310.37
D	Mirror Covers Chrome, Pair, 99-04 Grand Cherokee	13310.12
E	Mirror Covers Chrome, Pair, 05-07 Grand Cherokee	13310.22
F	Mirror Covers Chrome, Pair, 02-04 Liberty	13310.32
G	Door Handle Covers Chrome, 10 Piece Kit, 99-04 Grand Cherokee	13310.13
G	Door Handle Covers Chrome, 8 Piece Kit, 05-07 Grand Cherokee	13310.23
H	Door Handle Covers Chrome, 10 Piece Kit, 02-04 Liberty	13310.33
H	Door Handle Covers Chrome, 4 Piece Kit, 08-10 Liberty	13311.13
I	Fuel Door Cover Chrome, Each, 99-04 Grand Cherokee	13310.15
J	Fuel Cover Chrome, Each, Grand Cherokee 05-07	13310.25
J	Fuel Cover Chrome, Each, Liberty 02-04	13310.35
K	Pillar Trim Chrome, Pair, 99-04 Grand Cherokee	13310.17
L	Lift Gate Hinge Covers Chrome, Each, 99-04 Grand Cherokee	13310.14
L	Lift Gate Hinge Covers Chrome, Each, 05-07 Grand Cherokee	13310.24
M	Lift Gate Accent Trim Chrome, Each, 99-04 Grand Cherokee	13310.16
M	Lift Gate Accent Trim Chrome, Each, 05-07 Grand Cherokee	13310.26
N	Tail Light Trim Covers Chrome, Pair, 99-04 Grand Cherokee	13310.11
O	Tail Light Covers Chrome, Pair, Grand Cherokee 05-07	13310.21
P	Tail Light Covers Chrome, Pair, 02-04 Liberty	13310.31

Grille/Billet Grille Inserts

Durable UV treated inserts enhance the front of your Jeep®. Available in your choice of Black or Chrome with or without aluminum billet inserts, these inserts add great styling and a unique appearance. All Rugged Ridge inserts easily install without drilling or tools. Just click them in and go! Add on the NEW black or stainless Euro-Guards or black headlight bezels for the sharpest look on the market!

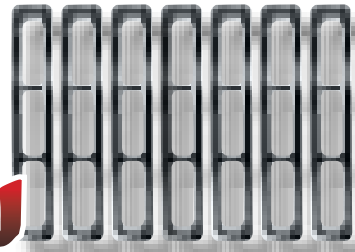

TJ



11306.30 Black Grille Inserts

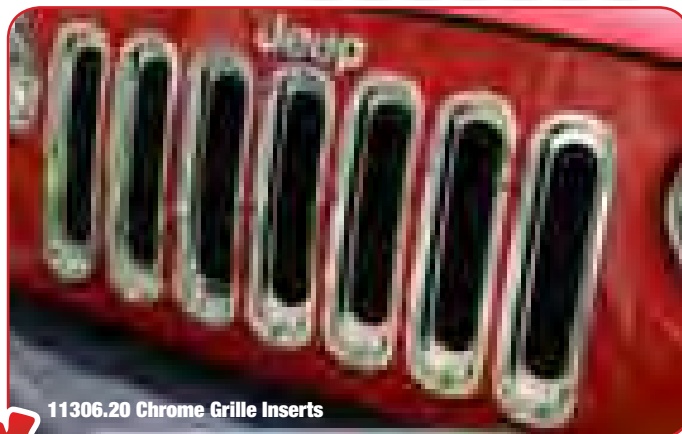

11306.20 Chrome Grille Inserts



11401.30 Black w/Aluminum Billet Grille Inserts



11401.20 Chrome w/Aluminum Billet Grille Inserts

JK

Grille Inserts	Chrome	Black
2007-10 Wrangler *, Set of 7	11306.20	11306.30
1997-06 Wrangler, Set of 7	11306.02	11306.03
1987-95 Wrangler, Set of 7	11306.01	11306.04

* Does not include horizontal supports - gives you a clean look!

Billet Grille Inserts	Polished Aluminum	Black Aluminum
2007-10 Wrangler, Set of 7	11401.20	11401.30
1998-06 Wrangler, Set of 7	11401.02	11401.03
1987-95 Wrangler, Set of 7	11401.01	-



11401.02 Chrome w/Aluminum Billet Grille Inserts

11306.03 Black Grille Inserts (inset)

Replacement Headlight Bezels

Complete the look of your front end with these easy to install head light bezels from Rugged Ridge. Each UV treated bezel easily attaches to factory mounting points creating a clean look. Matched up with the Rugged Ridge Grille Inserts, you now have that HOT look.



12419.25



12419.23 Headlight Bezels, Black

Headlight Bezels	Black	Chrome
07-10 Wrangler, Pair (NEW)	12419.25	13311.20
97-06 Wrangler, Pair	12419.23	12419.08
87-95 Wrangler, Pair	12419.24	12419.05
72-86 CJ, Pair	-	12419.04

Front Euro-Guards

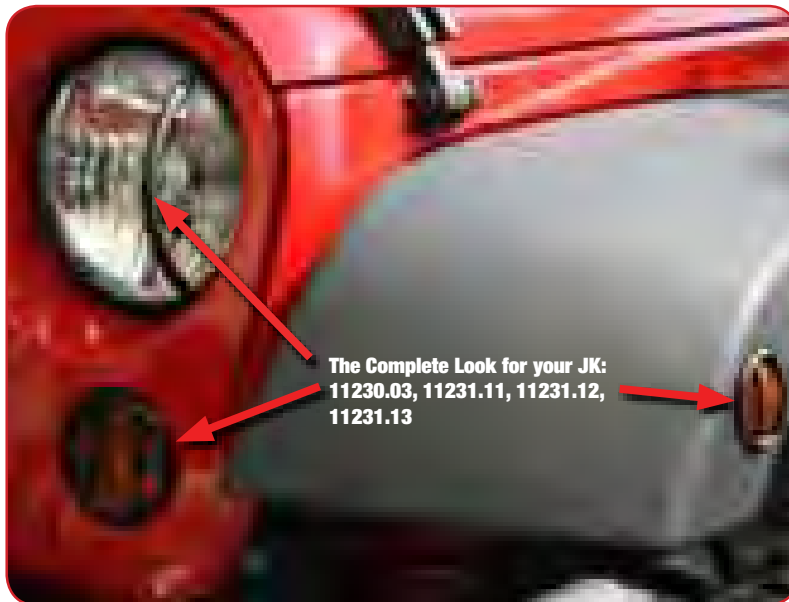

Protect your headlights from debris and get that offroad look with a set of Rugged Ridge Euro-Guards. Constructed of durable powder coated steel, these front Euro-Guards are designed to last. No drilling required for installation. Each kit comes with a pair of guards to cover both sides of the vehicle. The side marker light guards are a great complement to our front light Euro-Guards. Installation is easy and light visibility is not hampered. Sold in pairs. The turn signal light guards are designed to match our Headlight Euro-Guards. They feature the same great style and construction. They give a rugged look while protecting an important area. Sold in pairs.

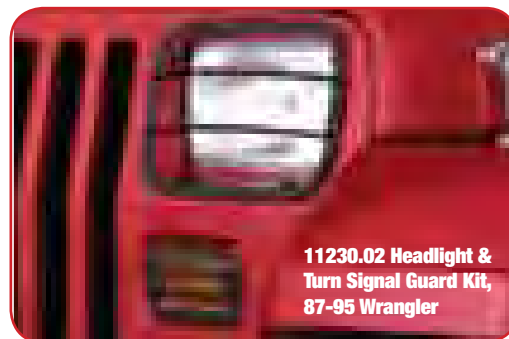

Black Front Euro Light Guards

JK

		Part #
07-10 Wrangler *, Pair	Head Light Guards	11230.03
97-06 Wrangler, Pair	Head Light Guards	11230.01
87-95 Wrangler, 4 pc. Kit	Head Light & Turn Signal Guard Kit	11230.02
07-10 Wrangler *, Pair	Turn Signal Guards	11231.11
07-10 Wrangler *, Pair	Side Flare Light Guards	11231.12
97-06 Wrangler **, 4 pc. Kit	Turn Signal & Side Flare Light Guard Kit	11231.01

* fits 2 and 4-Door Wrangler ** N. America models only

Fog Lamp Euroguards for 07-10 Wrangler

Protect those expensive fog lights from impact with the Rugged Ridge Euro Light Guards. Each Euro Light Guard is easy to install with no adhesive or drilling required. They are available in a textured black powder coat finish for long life and to match the other Rugged Ridge Euroguards.

EURO GUARD FOG LIGHT COVERS

	Part #
07-10 Wrangler (NEW)	11231.13

NEW!

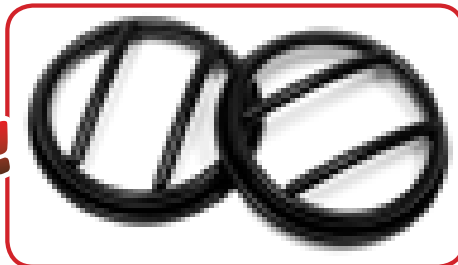

Billet and Regular Stone Guard Kits

Protect and enhance the look of your Jeep® with your choice of two types of stone guards. Each set includes six pieces to protect your headlights, taillights and turn signal indicators. The regular Stone Guards feature a durable wire mesh in durable black powder coat finishes. The Billet Stone Guards are also available in black and feature a contemporary look found nowhere else. Match these kits up with the Rugged Ridge Grill inserts and headlight bezels and you have a complete front end enhancement.

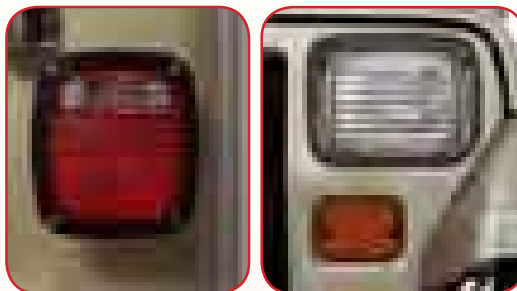

11236.20 Billet Stone Guard Set, 87-95 Wrangler

Stone Guard Kits	Part #
97-06 Wrangler, 6 pc. Kit	11236.01
87-95 Wrangler,	-
72-86 Wrangler	-
Billet Stone Guard Kits	
97-06 Wrangler, 6 pc. Kit	11236.21
87-95 Wrangler, 6 pc. Kit	11236.20



Make your Jeep® CJ or Wrangler unique with genuine Rugged Ridge black exterior accessories. All accessories are powder coated in a semi gloss finish to protect your investment against the elements. Every part or kit comes with complete hardware to ensure a trouble free installation. No matter if you choose our "Locking Hood Catch", "Gas Hatch Cover" or the complete "Hood Set", Rugged Ridge Accessories truly change and upgrade your Jeep® dramatically.

Hood Sets

11201.02 Hood Set, 98-06 Wrangler



11201.04 Hood Set, 07-10 Wrangler

JK

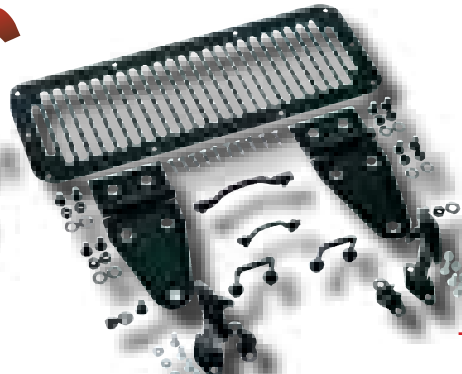

11201.01 Hood Set, 76-95 Jeep® CJ/Wrangler



Hood Set, Black	Part #
07-10 Wrangler, Set	11201.04
98-06 Wrangler, Set	11201.02
76-95 CJ/Wrangler *, Set	11201.01

* 76-95 kits include hood catches

11210.09 hood catch, 97-06 Wrangler



Hood Catches

Hood Catch, Black	Part #
97-06 TJ Hood Catch, Plastic, Each	11210.08
97-06 TJ Hood Catch, Plastic, Each	11210.09
87-95 Wrangler Matte, Each	11210.03
45-63 Vertical Mount, Each	11210.02
42-95, pair	11210.01
45-63 Vertical Mount, Each	11210.02



11210.01 Hood Catches

Locking Hood Catches



Locking Hood Catches, Black	Part #
97-06 Wrangler, Pair	11210.10

Hinge Treatments for 2007-10 Wrangler

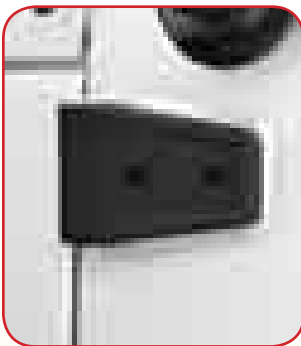

These cast steel design Hinge Treatments are guaranteed not to rust while providing a new beefy look. Door and Hood Hinge covers feature a easy-to-install design. Replacing your existing hinges can break & crack the surrounding paint, as the hinges were painted at the factory after installation. These covers retain the stock hinge but give it a new look without harming your expensive paint. A direct bolt on - no drilling required, fits either side. Use 4 hinge treatment pairs for 4-Door models, 2 pairs for 2-Door models and 1 pair for hood.

Hinge Treatment, Black	Part #
07-10 Wrangler, Pair	11205.10
07-10 Wrangler 2-Door, Set of 4	11202.04
07-10 Wrangler 4-Door, Set of 8	11202.05

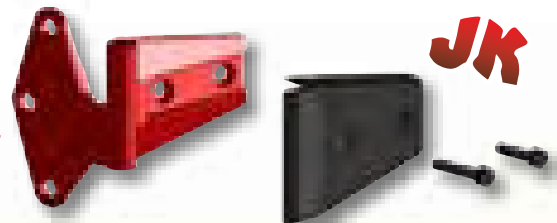

JK

Door Hinge Kit



11202.01 Door Hinge Kit, 87-06 Wrangler

Door Hinge Kit, Black	Part #
87-06 Wrangler w/ Half Doors, Kit	11202.01
97-06 Wrangler w/ Full Steel Doors, Kit	11202.01
76-93 CJ/Wrangler w/ Full Hard Doors, Kit	11202.02

Hood Hinges



11205.02 Hood Hinges 97-06 Wrangler

Hood Hinges	Part #
76-95 CJ/Wrangler, Pair	11205.01
97-06 CJ/Wrangler, Pair	11205.02

Lower Door Hinges

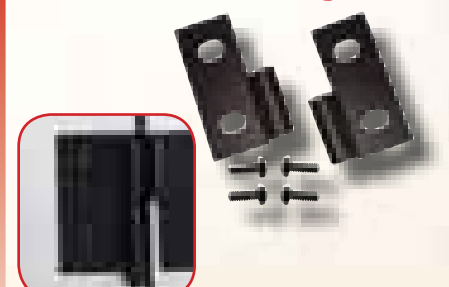

Lower Door Hinges, Black	Part #
76-06 CJ/Wrangler, Pair	11202.03

Hood Vent Covers

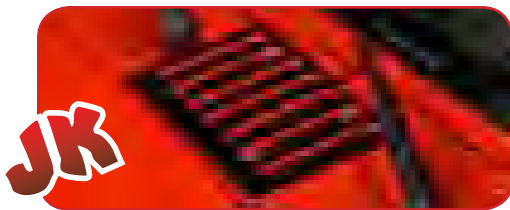

11206.05 Hood Vent Cover, 07-10 Wrangler

Hood Vent Cover	Part #
07-10 Wrangler, Each	11206.05
98-06 Wrangler, Each	11206.03
97 Wrangler, Each	11206.02
76-95 CJ/Wrangler, Each	11206.01

Windshield Hinges/ Brackets

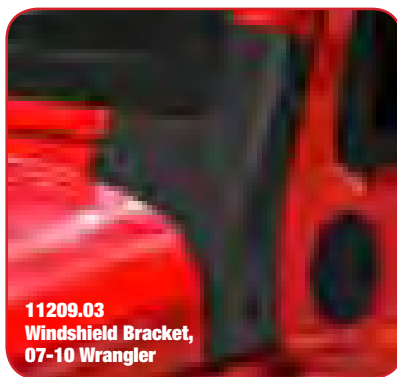

11209.03 Windshield Bracket, 07-10 Wrangler



11209.02 Windshield Hinges, 97-06 Wrangler

Black	Part #
07-10 Wrangler, Windshield Brackets, Pair	11209.03
97-06 Wrangler, Windshield Hinges, Pair	11209.02
76-95 CJ/Wrangler, Windshield Hinges, Pair	11209.01

Windshield Light Brackets

Special black powder coated brackets mount directly to the windshield hinge of your CJ or Wrangler. Allows for easy mounting of auxiliary lighting. Each bracket is custom designed for an exact mount and 07-10 model includes a rubber gasket to protect the paint during installation/removal. Sold in pairs.

Windshield Hinge Light Brackets	Part #
07-10 Wrangler, Pair	11027.03
97-06 Wrangler, Pair	11027.02
76-95 CJ/Wrangler, Pair	11027.01



11027.03 Windshield Hinge Light Bracket, 2007-10 Wrangler



11027.01 Windshield Light Bracket, 76-95 Wrangler

Footman Loops



Footman Loop (short only)	Part #
55-95 CJ/Wrangler, short, Each	11227.01
87-95 Wrangler, long, Each	11227.02

Windshield Tie Down Kits

These windshield tie down kits are made of steel, not plastic, for durability.

Windshield Tie Down Kits	Part #
07-10 Wrangler (1 footman loop, 2 hood bumper accents, & 1 washer nozzle cover), 4-Pc. Kit	11201.05
97-06 Wrangler (1 footman loop, 2 hood bumper accents, & 2 washer nozzle covers), 5-Pc. Kit	11104.03
55-95 CJ/Wrangler (2 footman loops & 2 windshield tie downs), 4-Pc. Kit	11211.01

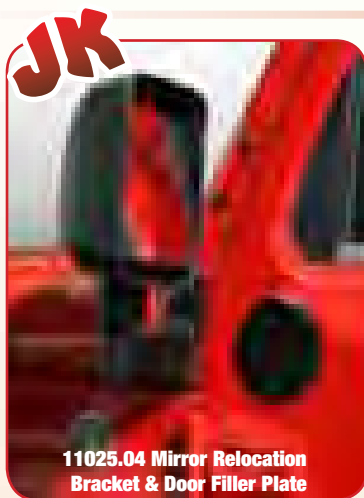

11025.04 Mirror Relocation Bracket & Door Filler Plate

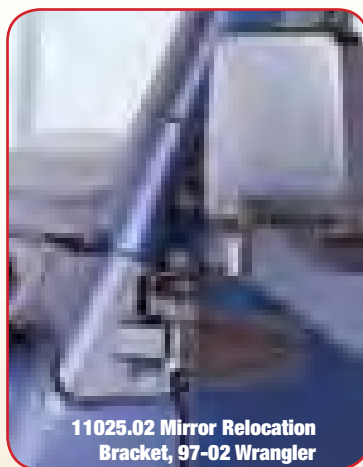

11025.02 Mirror Relocation Bracket, 97-02 Wrangler

Mirror Relocation Brackets

Custom designed brackets bolt into existing holes on the windshield relocating your mirrors off the door. The perfect add-on accessory for those offroad adventures where you do not want your doors. The 2007-10 Wrangler bracket kit comes with a filler plate to cover up the holes created when you remove your mirrors.



11205.03

Mirror Relocation Brackets, Black	Part #
07-10 Wrangler (w/Door Filler Plates), Pair	11025.04
03-06 Wrangler, Pair	11025.03
97-02 Wrangler, Half & Full Doors, Pair	11025.02
87-95 Wrangler, Half Doors, Pair	11025.01
94-95 Wrangler, Full Doors, Pair	11025.01

Billet Style Gas Covers

Create a custom look in just a few minutes. This special design fits directly over the existing gas cap opening. Available in locking and non-locking versions. They are specially treated to resist blemishes caused by gasoline or other hazardous chemicals. These covers install over the top of your factory gas cap into existing mounting points on 97-06 models. No drilling required. 2007-10 models attach with self tapping screws to plastic inner liner.



11229.01 Gas Hatch Cover, 97-06 Wrangler



11229.02 Gas Hatch Cover, 2007-10 Wrangler



11425.06 Locking Gas Hatch Cover, 2007-10 Wrangler

JK

Application	Finish	Part #
07-10 Wrangler	Black Aluminum, Each	11425.05
07-10 Wrangler	Black Aluminum, Locking, Each	11425.06
07-10 Wrangler	Black Painted Stainless, Each	11229.02
07-10 Wrangler	Black Painted Stainless, Locking, Each	11229.03
97-06 Wrangler	Black Aluminum, Each	11425.02
97-06 Wrangler	Black Aluminum, Locking, Each	11425.08
97-06 Wrangler	Black Painted Steel, Each	11229.01
97-06 Wrangler	Black Painted Steel, Locking, Each	11229.04

Radiator Bug Shields



Protect your front grille from bugs and debris with these durable Radiator Bug Shields by Rugged Ridge. Each externally mounted Bug Shield is perforated for unencumbered air flow and are available in black. All shields are bound by soft rubber to prevent vehicle scratching. Installation requires some drilling.

Radiator Bug Shields	Black
97-06 Wrangler, Each	11213.03
87-95 Wrangler, Each	11213.01
55-86 CJ, Each	11213.02

Caliper Dust Covers

If you are tired of constantly cleaning your expensive custom wheels from brake dust? These caliper dust covers will do the trick. The covers come in pairs and are black powder coated for maximum rust protection. Installation is easy and well worth the investment to finally have clean wheels.



11212.01 Dust Covers

Caliper Dust Cover	Black
78-86 CJ w/ 2 bolt caliper, Pair	11212.02
77-78 CJ w/ 6 bolt caliper, Pair	11212.01

Tow Hooks



11236.03 Front Tow Hook pair, 97-06 Wrangler

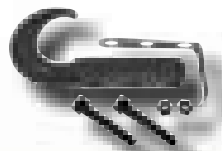

11236.02 Front Tow Hook, 42-04 Jeep® CJ/Wrangler

11236.04 Rear Tow Hook, 97-06 Wrangler



11236.05 Front Tow Hooks, 84-01 Cherokee

11236.06 Front Tow Hooks, 93-98 Grand Cherokee

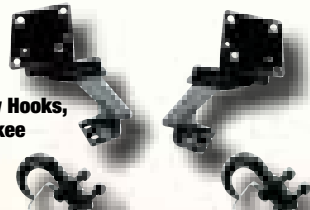

A solid recovery point is a must when venturing offroad. These tow hooks mount securely to the vehicle and make attaching ropes, straps and cables easy and convenient.

Tow Hooks, Black	Part #
97-06 Wrangler, Front, Pair	11236.03
97-06 Wrangler, Rear, Each	11236.04
42-04 CJ/Wrangler, Front, Each	11236.02
84-01 Cherokee, Front, Pair	11236.05
93-98 Grand Cherokee, Front, Pair	11236.06

Battery Tray



Battery trays take a beating. Replace yours with this powder coated design from Rugged Ridge. Mounts to factory mounting holes for ease of installation.

Battery Tray	Black
76-86 CJ, Each	11214.01

*See page 82 for Dual Battery Trays.

Rear Euro-Guards

Protect and upgrade the look of your Jeep® with a set of Rugged Ridge Euro Taillight Guards. Each Rear Euro Taillight Guard is easy to install with no drilling required. On 76-06 models, just remove your taillight, slip on the Euro-Guard and replace the taillight. Constructed of durable powder coated steel or polished stainless steel for long life and great looks. Plastic inserts around the mounting screws on 07-10 models keep the metal Euro Guard off the taillight, preventing scratching and rattles.

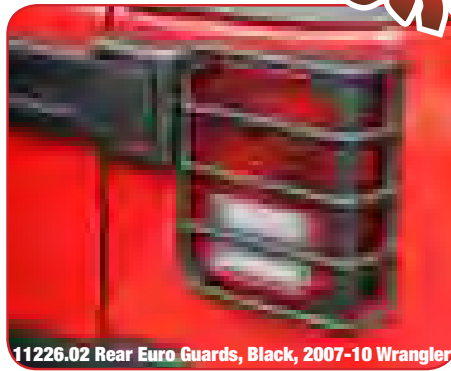

11226.02 Rear Euro Guards, Black, 2007-10 Wrangler



11226.01 Rear Euro Guards, Black, 76-06 Jeep CJ / Wrangler

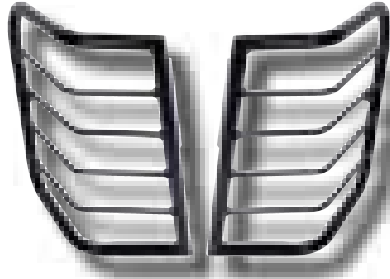

11226.20 Rear Euro Guards, Black, 1999-04 Grand Cherokee

Rear Euro Guards	Black	Titanium
07-10 Wrangler, Pair	11226.02	-
76-06 CJ/Wrangler, Pair	11226.01	11301.01
99-04 Grand Cherokee, Pair	11226.20	-
05-08 Grand Cherokee, Pair	11226.21	-

JK

Tire Stop

Replace your bent or rusted tire stop with a brand new Rugged Ridge factory style replacement tire stop. Powder coated for durability, this part will protect your taillight from your spare tire when opening the tailgate of your Jeep®.



Tire Stop, Black	Part #
76-95 CJ/Wrangler, Each	11217.01

License Plate Holder

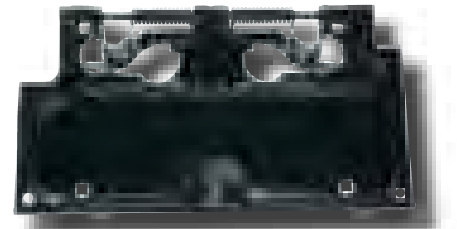

Having troubles getting to your gas cap because your license plate bracket is rusted or worn out? Replace your bent or rusted license plate holder with this brand new Rugged Ridge factory style replacement bracket. The part is black powder coated for maximum protection against the elements.

License Plate Holder	Black
87-95 Wrangler, Each	11233.01

Tailgate Hinges

These tailgate hinges are a direct replacement for the weak, bland stock pieces. Includes all necessary hardware.



11218.01 Tailgate Hinges, 87-95 Wrangler

Tailgate Hinges	Part #
87-95 Wrangler, Pair	11218.01
76-86 CJ Lower Hinges, Pair	11207.01

Bumperettes

Restore the look of your Jeep® with these classic Bumperettes. Constructed of black powder coated painted steel for long life.



11215.01 Bumperettes

Bumperettes	Part #
76-06 CJ/ Wrangler*, Pair	11215.01

* including Wrangler Unlimited



Full Frame Light Bar

This three-piece light bar simplifies your installation dramatically because you won't run the risk of scratching up your windshield frame trying to mount a heavy one-piece bar with four lights onto your windshield hinges. With this bar you can install one piece at a time. The bar is powder coated in black and packaged in a easy to ship box for your convenience.



JK

NEW!

Full Frame Light Bar	Black
07-10 Wrangler, 3 Pcs. (NEW)	11232.21
97-06 Wrangler, 3 Pcs.	11232.01



Rugged Ridge Body Armor for 2007-10 Wrangler

Get that offroad look with Rugged Ridge Body Armor! Each Body Armor piece is constructed of black diamond plate UV treated thermoplastic for the coolest, toughest looking upgrade for your Jeep®. Each body armor attaches to your Jeep® with ultra strong 3M tape to ensure a secure fit. Have a scratch or dent on your paint? Cover it up with Body Armor! Simply fill in the scratched area with touch-up paint (to prevent rust) and install the Body Armor. You have now repaired and upgraded! Available in individual pieces or complete styling "kits", so you can customize the look of your Jeep® the way you want.



Body Armor Components	07-10 Wrangler		Body Armor Kits for 07-10 Jeep® Wrangler		Part #
	2-Door	4-Door			
Rear Tall Corner, Pair	11651.02 (1)	11651.01 (1)	07-10 Wrangler 2-Door, Kit	Rear Tall Corners, Pair (11651.02) Rocker Side Panel, Pair (11651.06) Hood Stone Guard (11651.17)	11651.51 (1)
Rocker Side Panel, Kit	11651.06 (1)	11651.05 (1)	07-10 Wrangler 4-Door, Kit	Rear Tall Corners, Pair (11651.01) Rocker Side Panel, Pair (11651.05) Hood Stone Guard (11651.17)	11651.50 (1)
Hood Stone Guard, Each	11651.17 (1)	11651.17 (1)			

(1) cannot be used with Bushwacker brand rear flares or Rugged Ridge All Terrain Flares.



NEW!

Cowl Body Armor

JK

Cowl Body Armor	Part #
07-10 Wrangler Matte Black, Pair (NEW)	11651.18

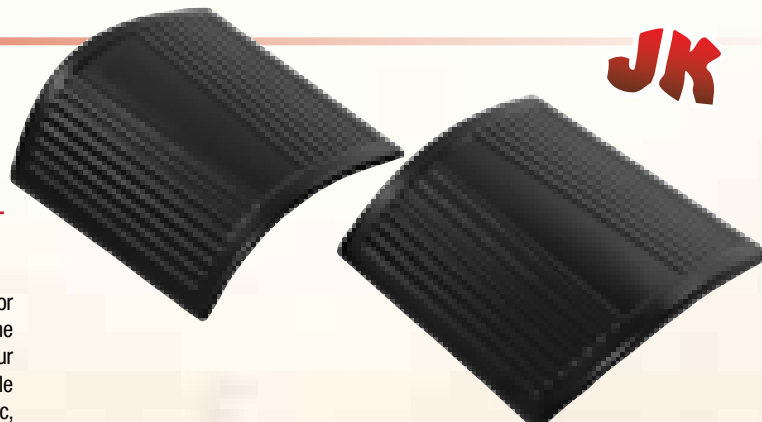

Protect your cowl from mirror damage with cowl body armor from Rugged Ridge. Whenever your door limiter straps come disconnected the door can over extend causing damage to your cowl area. These new cowl covers protect your cowl area while providing a great look. Constructed of durable UV thermoplastic, these covers easily attach using 3M double sided automotive grade adhesive. Packed in pairs.

Rugged Ridge Body Armor TJ

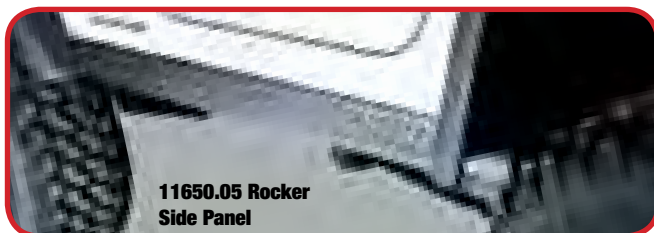
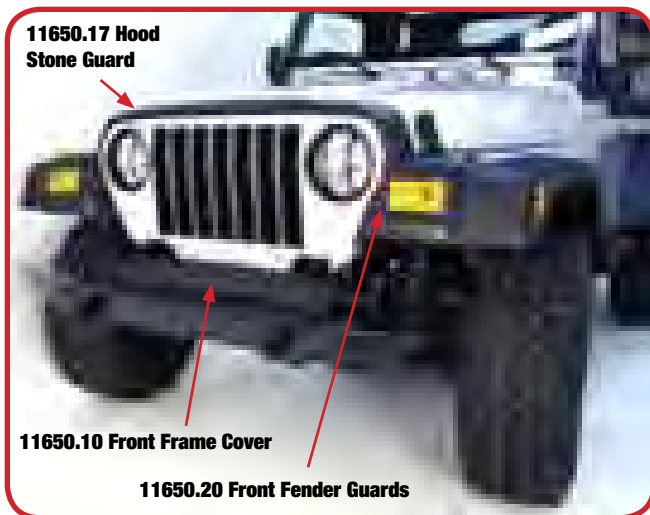

Body Armor Components	97-06 Wrangler
Rear Tall Corner, Pair	11650.01 (1) (6)
Rear Tall Corner, Pair	11650.02 (2) (6)
Rocker Side Panel, Kit	11650.05 (3) (5)
Front Frame Cover, Each	11650.10 (4)
Rear Tailgate Sill, Each	11650.15 (4)
Hood Stone Guard, Each	11650.17 (4) (7)
Front Fender Guards, Pair	11650.20 (4) (5)

- (1) cannot be used with Bushwacker brand rear flares or Rugged Ridge All Terrain Flares
- (2) can be used with Bushwacker brand rear flares and Rugged Ridge All Terrain Flares
- (3) can be used with Bushwacker brand or factory rear flares
- (4) also fits 03-06 Unlimited
- (5) will not fit Rubicon model
- (6) will not fit Unlimited model
- (7) may require under hood drilling



Body Armor Kits for 97-06 Jeep® Wrangler

Item/Feature	Components in Kit	Part #
97-06 Wrangler, Kit	Rear Tall Corners, Pair (11650.01) Rocker Side Panel, Pair (11650.05) Front Frame Cover (11650.10) Rear Tailgate Sill (11650.15) Hood Stone Guard (11650.17) Front Fender Corners, Pair (11650.20)	11650.50 (1) (6)
97-06 Wrangler, Kit	Rear Tall Corners, Pair (11650.02) Rocker Side Panel, Pair (11650.05) Front Frame Cover (11650.10) Rear Tailgate Sill (11650.15) Hood Stone Guard (11650.17) Front Fender Corners, Pair (11650.20)	11650.60 (2) (6)
97-06 Wrangler, Kit	Rear Tall Corners, Pair (11650.01) Rocker Side Panel, Pair (11650.05) Front Frame Cover (11650.10) Rear Tailgate Sill (11650.15)	11650.51 (1) (6)
97-06 Wrangler, Kit	Rear Tall Corners, Pair (11650.02) Rocker Side Panel, Pair (11650.05) Front Frame Cover (11650.10) Rear Tailgate Sill (11650.15)	11650.61 (2) (6)
97-06 Wrangler, Kit	Hood Stone Guard (11650.17) Front Fender Corners, Pair (11650.20)	11650.52 (3)
97-06 Wrangler, Kit	Front Frame Cover (11650.10) Rear Tailgate Sill (11650.15)	11650.53 (3)

Body Tub Rail Armor

Body Tub Rail Armor	Part #
97-06 Wrangler, Pair (NEW)	11650.40
04-06 Wrangler Unlimited, Pair (NEW)	11650.41
97-06 Wrangler w/ Bestop Supertop, Pair (NEW)	11650.41

Hide those unsightly scuffs and scratches on your TJ factory belt rail with the new Rugged Ridge Body Tub Rail Armor. These custom fit covers fit directly over your factory belt rails providing protection and a clean look. Each Rail armor attaches with Automotive Grade 3M adhesive and requires no drilling to install.

NEW!



Enhanced Four Color Skin Packaging

As always, Omix is continuously looking for ways to improve both the quality and the marketability of our products. In the recent months we have made significant improvement in our packaging. Many of our great new products like: All Terrain Floor Liners, Winches, and Recovery Gear come with slick new four color packaging that increases both the Retail and Out of Box experience. But we are not stopping there. Effective immediately Omix is offering four-color skin packaging for our hottest selling Rugged Ridge accessories. This process adheres product to a graphic cardboard backing with a clear plastic film. The result is an attractive yet pilfer resistant package that requires minimal shelf space for stocking. It drives home sales by giving consumers a full view of the part they are looking to purchase. Enhance your show room and POS displays by adding the hottest new accessories from Rugged Ridge today. A complete listing of the 165 parts available in skin packaging is located in Price List Section of our ecommerce site.

NEW!



12595.10
Pegboard Floor Display

12595.11 Two Sided Spinning Display

Products Available for Skin Packaging

INTERIOR ACCESSORIES

12663.01	DASH GRAB BAR, STAINLESS, 55-95 CJ & WRANGLER
12663.02	GAUGE COVER, STAINLESS, 76-86 CJ
12663.03	GLOVE BOX DOOR, STAINLESS, 76-86 CJ
12663.04	INTERIOR WINDSHIELD BRACKET PAIR, STAINLESS, 76-95 CJ & YJ WRANGLER
12663.05	STEERING COLUMN COVER, STAINLESS, 76-86 CJ
12663.06	SHIFTER BEZEL TRIM, MANUAL TRANSMISSION, BRUSHED SILVER, RUGGED RIDGE, JEEP WRANGLER (JK) 07-10
12663.07	AC VENT TRIM COVER, BRUSHED SILVER, RUGGED RIDGE, JEEP WRANGLER (JK) 07-10, SOLD IN PAIRS
12663.08	INTERIOR DOOR HANDLE COVER TRIM, BRUSHED SILVER, JEEP WRANGLER (JK) 07-10, PAIR
12663.09	SHIFTER BEZEL TRIM, MANUAL TRANSMISSION, CHROME, RUGGED RIDGE, JEEP WRANGLER (JK) 07-10
12663.10	AC VENT TRIM COVER, CHROME, RUGGED RIDGE, JEEP WRANGLER (JK) 07-10, PAIR
12663.11	INTERIOR DOOR HANDLE COVER TRIM, CHROME, JEEP WRANGLER (JK) 07-10, PAIR
12663.12	GRAB HANDLE, BLACK, 55-95 CJ & YJ WRANGLER
12663.13	GAUGE COVER, BLACK, 76-86 CJ
12663.14	INTERIOR WINDSHIELD BRACKETS, BLACK, 76-86 CJ
12663.15	FLASHLIGHT MOUNTING BRACKETS, RUGGED RIDGE, FOR 1.5-INCH DIAMETER FLASHLIGHTS
12663.16	TAILGATE STOP, 87 - UP WRANGLER
12663.17	BILLET TRANSFER CASE KNOB, 87-95 WRANGLER, 2H-4H-N-4L PATTERN
12663.18	INTERIOR WINDSHIELD KNOB PAIR, CHROME, 76-86 CJ
12663.19	BILLET ALUMINUM DASH KNOB SET, BLACK, 76-86 CJ
12663.20	CLIMATE CONTROL KNOB SET 3 PIECE BILLET ALUMINUM TJ 97-06 BLUE INDICATORS
12663.21	CLIMATE CONTROL KNOB SET 3 PIECE BILLET ALUMINUM TJ 97-06 RED INDICATORS
12663.22	CLIMATE CONTROL KNOB SET, BILLET ALUMINUM WITH BLUE INDICATORS, RUGGED RIDGE, JEEP WRANGLER (JK) 07-10, 3 PIECE
12663.23	CLIMATE CONTROL KNOB SET, BILLET ALUMINUM WITH RED INDICATORS, RUGGED RIDGE, JEEP WRANGLER (JK) 07-10, 3 PIECE
12663.24	BILLET SHIFT KNOB WITH 5-SPEED SHIFT PATTERN, MOST 97-06 WRANGLER AND SOME 94-95 MODELS
12663.25	BILLET SHIFT KNOB WITHOUT SHIFT PATTERN, MOST 85-85 CJ/WRANGLER AND SOME 97-98 WRANGLER
12663.26	BILLET SHIFT KNOB WITHOUT SHIFT PATTERN, MOST 97-06 WRANGLER AND SOME 94-95 MODELS
12663.27	NO DOORS, LIGHTS OUT SPRING PAIR. KEEPS YOUR INTERIOR LIGHTS OFF W/ DOORS REMOVED.
12663.28	HALF DOOR INSERTS, GRAY, 87-06 WRANGLER, 3 PACK

INTERIOR ACCESSORIES CONT.

12663.29	HALF DOOR INSERTS, BLACK, 87-06 WRANGLER, 3 PACK
12663.30	HALF DOOR INSERTS, SPICE 87-06 WRANGLER, 3 PACK
12663.31	CUP HOLDER, 76-95 CJ & YJ
12663.32	CLINOMETER WITH COMPASS
12663.33	INTERIOR WINDSHIELD KNOB, BLACK
12663.34	BILLET ALUMINUM DASH KNOB SET, CLEARCOATED, 76-86 CJ
12655.01	BILLET SHIFT KNOB W/ 5-SPEED PATTERN, MOST 55-85 CJ/WRANGLER AND SOME 97-98 WRANGLER

GRAB HANDLES & SPORTS BAR ACCESSORIES

12665.01	SPORTS BAR FLASHLIGHT HOLDER, BLACK, RUGGED RIDGE, UNIVERSAL APPLICATION
12665.02	ROLL BAR COAT HANGER PAIR FOR ALL JEEPS WITH ROLL BARS
12665.03	ULTIMATE ROLL BAR COAT HANGER, RUGGED RIDGE, CJ 55-86, JY 87-95, TJ 97-06, JK 07-10
12665.04	DOOR GRAB STRAP PAIR, CJ-YJ BLACK
12665.05	DOOR GRAB STRAP PAIR, TJ BLACK
12665.06	SPORT BARS DRINK CUP HOLDER PAIR, ALL CJ/WRANGLER
12665.07	ADJUSTABLE DOOR STRAP PAIR, 76-95 CJ & YJ WRANGLER
12665.08	SPORT GRAB HANDLES, ALL COVERED JEEP ROLL BARS (PAIR) 55-10
12665.09	DELUXE GRAB HANDLES, ALL COVERED JEEP ROLL BARS (PAIR) 55-10
12665.10	DUAL GRAB STRAP, WRANGLER/UNLIMITED 87-06
12665.11	DUAL REAR GRAB STRAP JK BLACK 07-10 - For use with Soft tops only
12665.12	DUAL GRAB STRAP REAR JK RED 07-10 - For use with Soft Tops only
12665.13	GRAB HANDLE, ULTIMATE REAR PAIR JK BLACK (ALSO FITS FRONT WINDSHIELD PILLAR LOCATION) 07-10
12665.14	GRAB HANDLE PAIR ULT REAR JK RED 07-10
12665.15	HOLDER RED FIRE EXTINGUISHER SPORT BAR
12665.16	HOLDER FIRE EXTINGUISHER BLACK SPORT BAR
12665.17	GRAB HANDLE PAIR NEOPRENE COVER BLACK 55-10
12665.18	GRAB HANDLE PAIR NEOPRENE REAR COVER RED 55-10
12665.19	ULTIMATE GRAB HANDLE- RED-ALL JEEP ROLL BARS (WITH OR WITHOUT COVERS), PAIR 55-10
12665.20	ULTIMATE GRAB HANDLE- BLACK-ALL JEEP ROLL BARS (WITH OR WITHOUT COVERS), PAIR 55-10

DOOR ENTRY GUARDS

12652.01	ENTRY GUARDS, STAINLESS, 76-95 JEEP CJ7 & WRANGLER, PAIR
12652.02	ENTRY GUARDS, STAINLESS, 97-06 JEEP WRANGLER, PAIR
12652.03	ENTRY GUARD, BLACK, 97-06 JEEP WRANGLER, PAIR

UTV ACCESSORIES

12698.01	UTV SPORT BAR PAIR BLACK CUP HOLDER
12698.02	UTV FIRE EXTINGUISHER HOLDER RED
12698.03	UTV FIRE EXTINGUISHER HOLDER BLACK

MIRRORS

12650.01	MIRROR KIT, CJ STYLE, BLACK, 87-95 WRANGLER
12650.02	MIRROR KIT, CJ STYLE, BLACK, 97-06 WRANGLER
12650.03	SIDE MIRROR PAIR, BLACK, 55-86 CJ
12650.04	MIRROR KIT, CJ STYLE, STAINLESS, 87-95 WRANGLER
12650.05	MIRROR KIT, CJ STYLE, STAINLESS, 97-06 WRANGLER

TOW HOOKS

12653.01	TOW HOOK, BLACK, JEEP 42-06 CJ & WRANGLER, UNIV APP, (SOLD EACH)
12653.02	TOW HOOK, CHROME, JEEP 42-06 CJ & WRANGLER, UNIV APP, (SOLD EACH)

GRILLE INSERTS

12654.02	GRILLE INSERTS, CHROME TRIM, 97-06 JEEP WRANGLER/UNLIMITED
12654.03	GRILLE INSERT SET CHROME JK WRANGLER 07-10

MIRROR RELOCATION BRACKETS

12656.01	MIRROR RELOCATION BRACKET PAIR, BLACK, 87-95 WRANGLER WITH HALF DOORS & 94-95 WRANGLER WITH FULL DOORS
12656.02	MIRROR RELOCATION BRACKET PAIR, BLACK, 97-02 WRANGLER
12656.03	MIRROR RELOCATION BRACKET PAIR, BLACK, 03-06 WRANGLER
12656.04	DOOR MIRROR RELOCATION BRACKETS, PAIR, BLACK 07-10 JK WRANGLER
12656.05	MIRROR RELOCATION BRACKET PAIR, STAINLESS, 87-95 WRANGLER W/ HALF DOORS & 94-95 WRANGLER WITH FULL DOORS
12656.06	MIRROR RELOCATION BRACKET PAIR, STAINLESS, 97-02 WRANGLER
12656.07	MIRROR RELOCATION BRACKET PAIR, STAINLESS, 03-06 WRANGLER
12656.08	DOOR MIRROR RELOCATE BRACKET PAIR, STAINLESS, 07-10 JK WRANGLER

WINDSHIELD LIGHT BRACKETS

12657.01	WINDSHIELD HINGE LIGHT BRACKET PAIR, STAINLESS, 76-95 CJ/WRANGLER
12657.02	WINDSHIELD HINGE LIGHT BRACKET PAIR, STAINLESS, 97-06 WRANGLER
12657.03	WINDSHIELD MOUNT LIGHT BRACKET PAIR STAINLESS JK WRANGLER 07-10

HOOD KITS

12658.01	COMPLETE HOOD KIT, 76-95 JEEP CJ & WRANGLER, STAINLESS
12658.02	COMPLETE HOOD KIT, 98-06 WRANGLER/UNLIMITED (HOOD CATCHES NOT INCL), STAINLESS
12658.03	HOOD DRESS UP KIT, STAINLESS STEEL, JK WRANGLER 07-10
12658.04	HOOD SET, 78-95 JEEP CJ & WRANGLER, BLACK
12658.05	HOOD SET, 98-06 JEEP WRANGLER, BLACK
12658.06	HOOD DRESS UP KIT, TEXTURED BLACK, JEEP WRANGLER (JK) 07-10

EURO LIGHT GUARDS

12659.01	EURO TAIL LIGHT GUARD, STAINLESS, 76-06 CJ WRANGLER
12659.02	TAIL LIGHT EURO GUARDS POLISHED STAINLESS STEEL 07-10 JK WRANGLER
12659.03	FRT SIDE MARKER & PARK EURO GUARDS, STAINLESS, 98-06 WRANGLER/UNLIMITED (4 PC)
12659.04	FRT, HEADLIGHT AND TURN SIGNAL GUARDS, STAINLESS, 87-95 WRANGLER (4-PC)
12659.05	EURO GUARD HEADLIGHT STAINLESS STEEL JK WRANGLER 07-10, PAIR
12659.06	EURO GUARD PAIR TURN SIGNAL STAINLESS STEEL JK WRANGLER 07-10
12659.07	EURO GUARD SIDE MARKER LIGHTS STAINLESS STEEL JK WRANGLER 07-10
12659.08	EURO TAIL LIGHT GUARD PAIR, BLACK, 76-06 CJ/WRANGLER
12659.09	EURO GUARD PAIR TAIL LIGHT BLACK JK WRANGLER OE STYLE 07-10
12664.05	FRT HEADLIGHT EUROGUARDS, STAINLESS, 97-06 WRANGLER/UNLIMITED (PAIR)

CHROME EXTERIOR TRIM

12666.01	DOOR HANDLE RECESS GUARDS, BLACK, RUGGED RIDGE, JEEP WRANGLER (JK) 07-10 2-DOOR, THREE PIECE SET
12666.02	DOOR HANDLE RECESS GUARDS, BLACK, RUGGED RIDGE, JEEP WRANGLER (JK) 07-10 4-DOOR, FIVE PIECE SET
12666.03	DOOR HANDLE RECESS GUARDS CHROME, WRANGLER (JK) 2-DOOR 07-10, 3 PC KIT
12666.04	DOOR HANDLE RECESS GUARDS CHROME, WRANGLER (JK) 4-DOOR 07-10, 5 PC KIT
12666.05	DOOR HANDLE COVER AND GUARD KIT, CHROME, JK 07-10 2-DOOR
12666.06	DOOR HANDLE COVER AND RECESS GUARD KIT, CHROME, RUGGED RIDGE, JEEP WRANGLER (JK) 07-10 4-DOOR
12666.07	HEADLIGHT TRIM, CHROME, RUGGED RIDGE, JK 07-10, PAIR
12666.08	TAIL LIGHT COVERS, CHROME, RUGGED RIDGE, JK 07-10
12666.09	TURN SIGNAL LAMP COVERS, CHROME, WRANGLER (JK) 07-10
12666.10	FUEL FILLER ACCENT TRIM, CHROME, RUGGED RIDGE, JK 07-10
12666.11	TAILGATE HINGE COVERS, RUGGED RIDGE, CHROME JK 07-10
12666.12	LIFT GATE HINGE COVERS, CHROME, JK 07-10 WITH HARDTOP
12666.13	ANTENNA BASE COVER, CHROME, RUGGED RIDGE, WRANGLER (JK) 07-10
12666.14	TIRE STOP, STAINLESS, 76-95 CJ/WRANGLER

HINGE TREATMENTS

12660.01	HOOD HINGES, 76-95 JEEP CJ & WRANGLER, STAINLESS
12660.02	HOOD HINGES, 97-06 JEEP WRANGLER/UNLIMITED, STAINLESS
12660.03	HOOD HINGE COVER, STAINLESS STEEL JK WRANGLER 07-10 PAIR
12660.04	HINGE DOOR PAIR 76-93 JEEP CJ & WRANGLER, STAINLESS
12660.05	HOOD HINGE COVER, STAINLESS STEEL JK WRANGLER 07-10 PAIR
12660.06	DOOR HINGES, 94-95 WRANGLER WITH FULL STEEL DOORS, STAINLESS
12660.07	LOWER DOOR HINGES, 76-06 JEEP CJ & WRANGLER/UNLIMITED, STAINLESS
12660.08	DOOR HINGE KIT, 97-06 JEEP WRANGLER WITH STEEL HALF DOORS, BLACK
12660.09	DOOR HINGE KIT, JEEP CJ7, SCRAMBLER, 76-93 WRANGLER WITH FULL STEEL DOORS, BLACK
12660.10	LOWER DOOR HINGE BRACKETS, 76-06 JEEP CJ & WRANGLER, BLACK
12660.11	HOOD HINGES, 97-06 WRANGLER, PAIR, BLACK
12660.12	HINGE COVERS, TEXTURED BLACK, JK WRANGLER 07-10 2- DOOR; FITS DOOR AND HOOD HINGES
12660.13	HOOD HINGES, 76-95 JEEP CJ & WRANGLER, BLACK
12660.14	DOOR BRACKET, 81-95 CJ & WRANGLER, STAINLESS

HOOD CATCHES & LOCKS

12661.01	HOOD CATCH, 97-06 JEEP WRANGLER/UNLIMITED, CAST STAINLESS
12661.02	HOOD CATCH SET, RUGGED RIDGE, STAINLESS STEEL JK WRANGLER 07-10
12661.03	HOOD CATCH KIT, 42-95 JEEP, STAINLESS
12661.04	HOOD CATCH KIT (BLACK PLASTIC- OE REPLACEMENT) 97-06 JEEP WRANGLER/UNLIMITED
12661.05	HOOD CATCH KIT CHROME PAIR
12661.06	HOOD LOCK KIT, 72-86 CJ
12661.07	HOOD LOCK KIT, 87-95 WRANGLER
12661.08	HOOD LOCK KIT, 97 WRANGLER
12661.09	HOOD LOCK KIT, 97-06 WRANGLER
12661.10	LOCKING HOOD CATCH KIT, 97-06 WRANGLER/UNLIMITED, CHROME
12661.11	LOCKING HOOD CATCH KIT, 97-06 JEEP WRANGLER, BLACK
12661.12	HOOD LOCK JK WRANGLER 07-10
12661.13	HOOD CATCH KIT, 42-95 JEEP CJ & WRANGLER, BLACK

WIPER MOTOR COVERS

12662.01	WIPER COVER, STAINLESS, 68-75 CJ
12662.02	WIPER COVER, STAINLESS, 76-86 CJ

FUEL DOORS

12664.01	GAS HATCH COVER, STAINLESS, 97-06 WRANGLER
12664.02	FUEL COVER, POLISHED STAINLESS STEEL, JK WRANGLER 07-10
12664.03	FUEL COVER LOCKING, POLISHED STAINLESS STEEL, JK WRANGLER 07-10
12664.04	GAS HATCH COVER TJ 1997-06 POLISHED STAINLESS STEEL LOCKING
12664.06	GAS HATCH COVER, 97-06 JEEP WRANGLER, BLACK (STEEL)
12664.07	FUEL COVER BLACK STAINLESS STEEL JK WRANGLER 07-10
12664.08	FUEL COVER LOCKING, BLACK STAINLESS STEEL, JK WRANGLER 07-10
12664.09	GAS HATCH COVER TJ 1997-06 BLACK STAINLESS STEEL LOCKING
12664.10	BILLET STYLE GAS COVER, POLISHED ALUMINUM, 97-06 WRANGLER
12664.11	BILLET STYLE GAS COVER, BLACK, 97-06 WRANGLER
12664.12	FUEL COVER CHROME JK WRANGLER 07-10
12664.13	FUEL COVER CHROME, RUGGED RIDGE, JK WRANGLER 07-10 LOCKING
12664.14	FUEL COVER BLACK ALUMINUM JK WRANGLER 07-10
12664.15	FUEL COVER BLACK ALUMINUM, JK WRANGLER 07-10 LOCKING
12664.16	GAS HATCH COVER TJ 97-06 POLISHED ALUMINUM LOCKING
12664.17	GAS HATCH COVER TJ 97-06 BLACK ALUMINUM LOCKING

MANUAL LOCKING HUBS

12667.01	MANUAL LOCKING HUBS, RUGGED RIDGE, FORD RANGER 98-00, MAZDA B3000/B4000 01-08 PAIR
----------	--

DIFFERENTIAL SKID PLATES

12668.01	SKID PLATE DIFFERENTIAL DANA 30 BLACK
12668.02	HEAVY DUTY DIFFERENTIAL SKID PLATE- DANA 35
12668.03	HEAVY DUTY DIFFERENTIAL SKID PLATE- DANA 44
12668.04	DIFFERENTIAL SKID PLATE, JEEP LOGO, DANA 30, MOPAR LICENSED
12668.05	DIFFERENTIAL SKID PLATE, JEEP LOGO, DANA 35, MOPAR LICENSED
12668.06	DIFFERENTIAL SKID PLATE, JEEP LOGO, DANA 44, MOPAR LICENSED

Rugged Ridge Heavy Duty 8,500 LB Winch

- Durable 5.5 HP Series Wound motor for long life and extra pulling power
- Tough 3 stage planetary gear box with a 172.8:1 gear ratio delivering power and reliability
- Includes 94' of 5/16" diameter wire rope and latched hook
- Automatic load holding brake system (in the drum brake system)
- Exclusive light mount roller fairlead included- allows for easy no-drill mounting of up to 2 off road lights!
- Tough stainless hardware is used on the body of the winch to eliminate rust
- Each winch includes a durable 12' all weather cable remote solenoid box that can be mounted in multiple positions (over cable or over motor) and angles to accommodate most winch bumpers including the Rugged Ridge® XHD Bumper System!
- Limited 3 year warranty against manufacturing defects

NEW!



8,500LB LINE SPEED & AMP DRAW-FIRST LAYER for Wire Cable and Synthetic Rope Winches

Line Pull	Lbs	No Load	2000	4000	6000	8000	8500
Line Speed	Ft/min	37.2	18	13.1	10.2	8.2	7.2
Motor Current	amps	70	190	260	335	410	425



EXCLUSIVE LIGHT MOUNT ROLLER FAIRLEAD INCLUDED WITH BOTH WIRE CABLE WINCHES

8,500 LB. Heavy Duty Winch with Steel Cable Part #
8,500 LB Heavy Duty Winch with Steel Cable (NEW) 15100.01

Rugged Ridge Heavy Duty 10,500 LB Winch

- Durable 6.6 HP Series Wound motor for long life and extra pulling power
- Tough 3 stage planetary gear box with a 218:1 gear ratio delivering power and reliability
- Includes 94' of 23/64" diameter wire rope and latched hook
- Automatic load holding brake system (in the drum brake system)
- Exclusive light mount roller fairlead included- allows for easy no-drill mounting of up to 2 off road lights!
- Tough stainless hardware is used on the body of the winch to eliminate rust
- Each winch includes a durable 12' all weather cable remote solenoid box that can be mounted in multiple positions (over cable or over motor) and angles to accommodate most winch bumpers including the Rugged Ridge® XHD Bumper System!
- Limited 3 year warranty against manufacturing defects

ALL WEATHER 12' CABLE REMOTE INCLUDED WITH ALL WINCHES



NEW!



10,500LB LINE SPEED & AMP DRAW-FIRST LAYER for Wire Cable and Synthetic Rope Winches

Line Pull	Lbs	No Load	2000	4000	6000	8000	10500
Line Speed	Ft/min	29.5	14.4	11.9	9.85	8.7	7.2
Motor Current	amps	70	170	240	310	380	425

10,500 LB. Heavy Duty Winch with Steel Cable Part #
10,500 LB Heavy Duty Winch with Steel Cable (NEW) 15100.10

Rugged Ridge Synthetic Rope Performance Winches!

We have taken the high quality features of our regular winch and replaced the steel cable with genuine Dymeema SK-75 Synthetic Rope for a lighter weight, high performance winch option. The synthetic rope used on Rugged Ridge winches is custom designed for heavy duty use and combined with the included polished aluminum hawse fairlead and 12' hook, will provide the ultimate in pulling power.

Rugged Ridge 8,500 Synthetic Rope Winch- 11/32" x 100', Breaking Force 16,550lbs

- Constructed with Dyneema SK-75 fiber from the Netherlands.
- Same high strength fabric used in ballistic body armor.
- Significantly stronger than same diameter steel cable and up to 40% stronger than Kevlar.
- 1/7 the weight of the same diameter wire rope.
- Will not splinter, kink or curl like wire rope & floats in water.
- Specially coated to be resistant to UV, abrasions, and chemical solvents.
- Heavy Duty 11/32" 12-strand braid with a breaking force of 16,550lbs
- Hawse fairlead included

8,500 LB Performance Winch with Synthetic Rope Part

8,500 LB Performance Winch with Synthetic Rope (NEW) 15100.02

See previous page for line speed charts



Stubby Bumper shown, located on page 10.



NEW!

**ALL WEATHER 12' CABLE
REMOTE INCLUDED
FOR ALL WINCHES**



Rugged Ridge 10,500 Synthetic Rope Winch-3/8" x 94', Breaking Force 19,310lbs

- Constructed with Dyneema SK-75 fiber from the Netherlands.
- Same high strength fabric used in ballistic body armor.
- Significantly stronger than same diameter steel cable and up to 40% stronger than Kevlar.
- 1/7 the weight of the same diameter wire rope.
- Will not splinter, kink or curl like wire rope & floats in water.
- Specially coated to be resistant to UV, abrasions, and chemical solvents.
- Heavy Duty 3/8" 12-strand braid with a breaking force of 19,310lbs
- Protective sleeves keep line from overheating on winch drum.
- Hawse fairlead included

10,500 LB Performance Winch with Synthetic Rope Part

10,500 LB Performance Winch with Synthetic Rope (NEW) 15100.11

See previous page for line speed charts



NEW!

**ALL RUGGED RIDGE
SYNTHETIC WINCHES
INCLUDE AN ALUMINUM HAWSE FAIRLEAD**

Why Synthetic Winch Rope?

Stronger and lighter, the two key elements of Synthetic Rope that make it the choice of competition off road vehicles everywhere. Rugged Ridge high strength synthetic Winch Rope is constructed from genuine Dyneema SK-75 fiber imported from the Netherlands. This revolutionary fiber is the choice of off-road enthusiast worldwide. It is stronger and lighter than wire rope and never kinks or splinters! Our synthetic line is woven from twelve UV-treated strands, resulting in increased strength, and a power to weight ratio unmatched by wire rope. Each synthetic rope comes with a protective sleeve that prevents it from overheating on the winch drum, black powder coated latched hook, stainless steel thimble, and is pre-terminated end for ease of installation. Synthetic rope does not store energy like steel cables, and in the event of a failure it is much less likely to result in severe injuries caused by the whiplash of broken wire rope.

- Same high strength fabric used in ballistic body armor.
- Significantly stronger than same diameter steel cable and up to 40% stronger than Kevlar.
- 1/7 the weight of the same diameter wire rope.
- Will not splinter, kink or curl like wire rope & floats in water.
- Specially coated to be resistant to UV, abrasions, and chemical solvents.
- Protective sleeves keep line from overheating on winch drum.



Winch Cover

Keep your winch looking as good as the day you bought it with the Rugged Ridge winch cover. Constructed of durable vinyl with reinforced grommets. Custom fit for Rugged Ridge Winches

Rugged Ridge Winch Cover Part

Winch Cover, All Rugged Ridge Winches (NEW) 15102.02

*Will not fit UTV winches

NEW!



Recovery Gear

The **Rugged Ridge Recovery Kit** includes everything you need to help your buddy next time he gets stuck in the mud. The durable carrying case is filled with our most popular recovery products to make sure you can get out of those trouble spots quickly and safely. Each kit contains the following:

- Durable Recovery Gear Bag.
- Heavy Duty 8" 20,000lb Snatch Block Pulley.
- Premium 2" x 30' 20,000lb Recovery Strap.
- Premium 3" x 6' 30,000lb Tree Trunk Protector Strap.
- Heavy Duty 9,500lb zinc coated pair of D-Rings.
- Winch Line Dampener.
- Pair of leather Recovery Gloves.

Recovery Gear also sold separately.



NEW!



Rugged Ridge Recovery Gear Kit	Part #
Recovery Gear, Kit (NEW)	15104.25

SEE PAGE 113-114 FOR AVT/UTV RECOVERY GEAR AND WINCHES

Don't Need Everything In Our Recovery Kit? Customize Your Own And Get Just What You Need!

NEW!

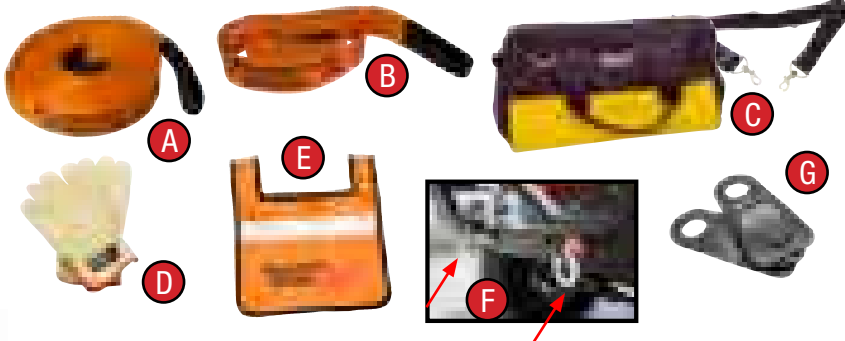

Rugged Ridge Recovery Gear	Part #
A Recovery Strap 3" x 30' 30,000 lbs, Each (NEW)	15104.01
A Recovery Strap 2" x 30' 20,000 lbs, Each (NEW)	15104.02
A Recovery Strap 4" x 30' 40,000 lbs, Each (NEW)	15104.03
B Tree Trunk Protector, 3" x 6' 30,000 lbs, Each (NEW)	15104.10
C Recovery Bag, Each (NEW)	15104.40
D Recovery Gloves, Pair (NEW)	15104.41
E Winch Line Dampener, Each (NEW)	15104.43
F Heavy Duty 9,500 lb Zinc Coated D-Rings, Pair (NEW)	11235.01
G Heavy Duty 8" 20,000 lb Snatch Block Pulley, Each (NEW)	11235.10

Tire Repair Kit

The Rugged Ridge Tire Repair Kit is essential recovery gear for any road or trailside tire repair. The kit includes: 2 sturdy aluminum handles, 2 reamers, 2 needles, 2 Allen head wrenches, and 25 self vulcanizing tire plugs all self contained in a heavy duty storage case. Be prepared for what ever the trail throws at you!

Rugged Ridge Tire Repair Kit	Part #
Tire Repair Kit, Each (NEW)	15104.51



NEW!

NEW!

Tire Deflator Kit

Fully inflated tires are great for the road and gas mileage, but they deliver a washboard ride on the trail. Air down your tires for a softer ride and more tread grip. The Tire Deflator Kit includes 4 tire deflators that will allow you to easily deflate your tires before heading out on the trail. All pieces connect together onto a key chain for ease.

Rugged Ridge Tire Deflator Kit	Part #
Tire Deflator Kit, 4 Pieces (NEW)	15104.50

Tri Fold Recovery Shovel

The Rugged Ridge Tri Fold Recovery Shovel is a fully functional collapsible shovel that features two serrated edges for cutting or digging. The heavy duty black powder coated body is 23 inches when open and folds to a mere 9 inches. It can be stowed easily in any vehicle, but is still rugged enough for the toughest of jobs. Includes durable storage case.

Rugged Ridge Tri Fold Off Road Shovel	Part #
Tri Fold Off Road Shovel, Each (NEW)	15104.42

NEW!



Replacement Synthetic Winch Rope

Stronger and lighter, the two key elements of Synthetic Rope that make it the choice of competition off road vehicles everywhere. Rugged Ridge high strength Synthetic Winch Rope is constructed from genuine Dyneema SK-75 fiber imported from the Netherlands. This revolutionary fiber is the choice of off-road enthusiast worldwide. It is stronger and lighter than wire rope and never kinks or splinters! Our synthetic line is woven from twelve UV-treated strands, resulting in increased strength, and a power to weight ratio unmatched by wire rope. Each synthetic rope comes with a protective sleeve that prevents it from over heating on the winch drum, black powder coated latched hook, stainless steel thimble, and is pre-terminated end for ease of installation. Synthetic rope does not store energy like steel cables, and in the event of a failure it is much less likely result severe injuries caused by the whiplash of broken wire rope. Each replacement rope kits can be easily attached to your current winch by removing your current steel cable and roller fairlead. A new Hawse Fairlead will be required for use with Synthetic Rope.

NEW!



Synthetic Winch Rope	Part #
Synthetic Winch Rope 1 1/32" x 100', Breaking Force of 16,550 lbs, Each (NEW)	15102.10
Synthetic Winch Rope 3/8" x 94', Breaking Force of 19,310 lbs, Each (NEW)	15102.11
Synthetic Winch Rope 3/16" x 50", UTV, ATV, Breaking Force of 4,600 lbs, Each (NEW)	15102.30
Synthetic Winch Rope 1/4" x 50", UTV, ATV, Breaking Force of 8,400 lbs, Each (NEW)	15102.31



Aluminum Hawse Fairlead

This hawse fairlead will help guide the synthetic winch rope to and from the spool. The Rugged Ridge UTV hawse fairlead features the Rugged Ridge logo etched into the top to show your loyalty to your favorite brand! Includes hardware.

Aluminum Hawse Fairlead	Part #
Aluminum Hawse Fairlead, Each	11238.01
Aluminum Hawse Fairlead for UTV, Each (NEW)	61238.01



Winch Cable Handle

The winch hook handle is the perfect solution for handling a winch cable. It is constructed of tough nylon webbing with a molded sure-grip handle. Perfect for getting a good solid grip of the winch hook when free spooling cable for a recovery and a safe way to respool your cable without endangering your fingers. Just slip your winch hook through the nylon webbing and you are ready to rock!

Winch Cable Handle	Part #
Winch Cable Handle, Each (NEW)	15102.01

Universal Winch Mount Plate

This winch mounting plate is designed to use OE bumper bolt holes. It can be used with any standard bottom mount winch with a 10" x 4.5" bolt pattern. Tough powder coated steel provides a long durable mount point.

Universal Winch Mount Plate	Part #
Universal Winch Mount Plate *, Each Fits: YJ 87-95, TJ 97-06, LJ 04-06	11238.10

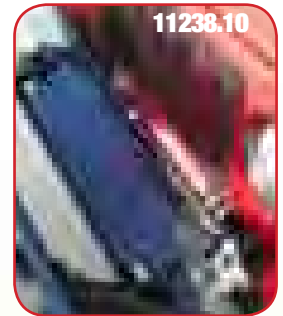

* Does not work with Tube Bumper

Roller Fairlead License Plate Holder

If your state requires a front license plate, we have a solution for you. Instead of drilling holes in your bumper or risking not running a front plate, this easy to install license plate holder attaches to your winch roller fairlead. Simply bolt your license plate to the bracket and snap the holder in place. Your license plate is now securely mounted yet easily removable for winching.

Roller Fairlead License Plate Holder	Part #
Roller Fairlead License Plate Holder, Each (NEW)	11238.05

Light Mount Roller Fairlead

Turn your roller fairlead into an off road light mount! This revolutionary new design allows for two off road lights to be easily mounted while not interfering with the winch operation. Replacement Roller Fairleads are also available without the light mounts.

Light Mount Roller Fairlead	Part #
Light Mount Roller Fairlead, Each (NEW)	11238.03



Gas Tank Skid Plates

The last thing you want to happen on a trail ride is to lose the only thing that keeps your engine running: gas. That's why Rugged Ridge has custom designed this Skid Plate to protect the gas tank on 1987-06 Wranglers. This overbuilt skid plate is a must for those who want that extra bit of protection for their off road adventures. Constructed of durable 3/16" thick powdercoated steel with a rust resistant E-Coating, this Skid Plate is designed to take whatever the trail throws at you! Bolt-on installation using existing frame mounting locations. This skid plate replaces the factory skid plate.



18003.22 Gas Tank Skid Plate, 1997-06 Wrangler

Gas Tank Skid Plates	Part #
97-06 Wrangler, Each (NEW)	18003.22
87-95 Wrangler, Each (NEW)	18003.21

18003.21 Gas Tank Skid Plate, 1987-95 Wrangler

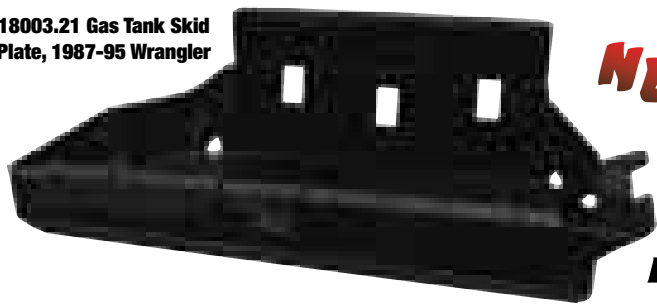

NEW!

18003.22 Gas Tank Skid Plate, 1997-06 Wrangler

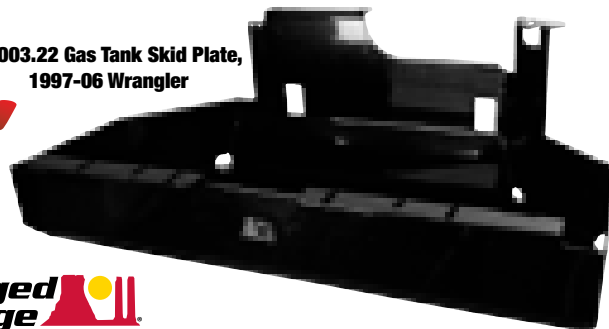

Skid Plate For 2007-10 Wrangler JK

Custom designed to protect the steering components on all 2007-10 Jeep Wranglers, this overbuilt skid plate is a must for those off road adventures. Constructed of durable 1/4" powdercoated steel with a rust resistant E-Coating, this Skid Plate is designed to take whatever the trail throws at you! Designed to fit with all Rugged Ridge front bumpers (looks amazing with the XHD Bumper system!) or all factory front bumpers, this skid plate provides protection for all front steering components including the very expensive electric sway bar disconnect system found on Rubicon models. Easy to install frame mount design incorporates special gussets and welded brackets to ensure long life and great off road performance.



Front Skid Plate for 07-10 Wrangler

Part #

Front Skid Plate- All RR bumpers, all factory original bumpers (NEW) 18003.30

EVAPORATOR SKID PLATE

Rugged Ridge offers a wide variety of skid plates and body protection for Wranglers. You can wheel with confidence knowing these skid plates will help keep you from getting hung up on rocks, trail obstacles, while preventing damage to critical components. The Evaporator Skid Plate is constructed of durable 3/16" thick black powder coated steel, and mounts to existing body holes using the factory hardware. It helps transfer the load of an impact away from the evaporator tank and to the frame and cross member.

NEW!

Evaporator Skid Plate	Part #
07-10 Wrangler (NEW)	18003.40



MUFFLER SKID PLATE JK

Rugged Ridge offers a wide variety of skid plates and body protection for Wranglers. You can wheel with confidence knowing these skid plates will help keep you from getting hung up on rocks, trail obstacles, while preventing damage to critical components. The Muffler Skid Plate is constructed of durable 5mm thick black powder coated steel, and mounts to existing body holes using the factory hardware. It helps transfer the load of an impact away from the muffler and to the frame.

NEW!

Muffler Skid Plate	Part #
07-10 Wrangler (NEW)	18003.31

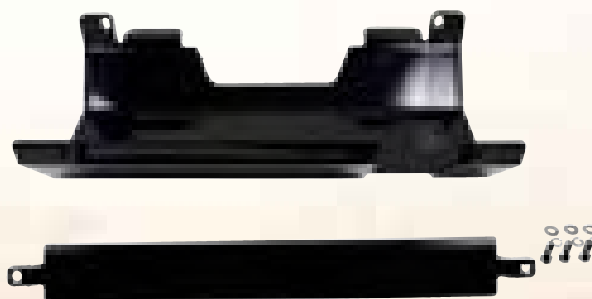

Heavy-Duty Differential Covers

Indestructible! You won't break these covers, we guarantee it. Made of 3/8" cast steel, painted black inside and out, these heavy-duty covers are designed to protect your differential and all its working parts for as long as you own your vehicle. These indestructible covers have been "44 caliber tested" - if they can take a bullet at point blank range (don't try this at home!), they can take all that the trail has to offer. Available for most popular Dana differential types and include extra reinforcement protection for the fill plug area. All mounting hardware and instructions are included for easy of installation.

Differential Cover	Part #
AMC 20, Each	16595.20
Dana 30, Each	16595.30
Dana 35, Each	16595.35
Dana 44, Each	16595.44
Dana 60, Each	16595.60



Heavy-Duty Differential Skid Plates

Protect your factory differential cover with these heavy-duty skid plates. Designed to fit the contours of your stock differential cover. Constructed of durable 3/16" black powder coated steel, these skid plates will help you slide over obstacles and not get hung up. Includes replacement mounting hardware and instructions. Now available with the Jeep® logo stamped into the face as an Authentic Jeep® Licensed product.

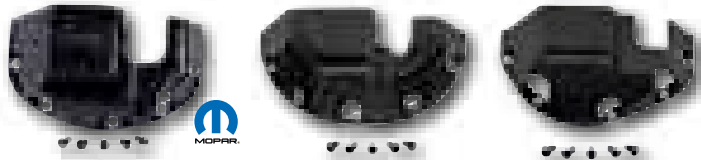

16597.30	Dana 30 Diff. Skid Plate
DMC-16597.30	Dana 30 Diff. Skid Plate with Jeep Logo
16597.35	Dana 35 Diff. Skid Plate
DMC-16597.35	Dana 35 Diff. Skid Plate with Jeep Logo
16597.44	Dana 44 Diff. Skid Plate
DMC-16597.44	Dana 44 Diff. Skid Plate with Jeep Logo

Control Arm Skid Plates

Protect your control arms with these easy to install skid plates. Constructed of durable 3/16" black powder coated steel, these skid plates will help prevent getting hung up on rocks and other trail obstacles. Simply unbolt your control arm at the axle and slide this skid plate in place. Sold as a pair. Available for front and rear axles.

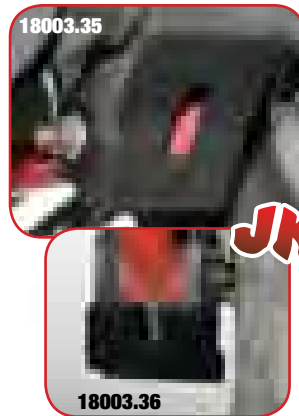

Control Arm Skid Plates	Part #
07-10 Wrangler, Front, Pair	18003.35
07-10 Wrangler, Rear, Pair	18003.36
07-10 Wrangler, Front & Rear, Kit	18003.37

Steering Box Skid Plate

Damage to the steering box can put a serious damper on a day of wheeling. That's why Rugged Ridge offers piece of mind with this tough skid plate. Constructed of durable 3/16" thick powdercoated steel with a rust resistant E-Coating, this skid plate will keep rocks and trail debris from damaging your steering box. The low profile design keeps ground clearance at a maximum. Installation uses existing mounting locations.



NEW!

18003.12



Steering Box Skid Plate	Part #
87-95 Wrangler, Each (NEW)	18003.11
97-06 Wrangler, Each (NEW)	18003.12
04-06 Wrangler Unlimited, Each (NEW)	18003.12

Dual Battery Tray Kits

Outfitting a trail rig can add greater strain to the electrical system. Adding on a winch, air compressor, fog lights, driving lights, a spot light, electric fuel pump, and a stereo amp can really tax the battery. A great way to combat that strain is to install dual batteries. This is especially true when using a winch, which can draw big amps for an extended period. These kits are designed to mount two batteries in place of the factory single battery location. The trays and brackets feature a black powdercoated finish. These are mounting kits only and do not include any wiring. A suggested wiring diagram is included. 70-95 CJ & Wrangler kits place the batteries side-by-side and may be used with lead acid or cylindrical-style sealed gel cell batteries. 97-06 TJ Wrangler kits stack the batteries and are for use with cylindrical-style sealed gel cell batteries only due to the battery mounting direction.

NEW!



11214.52

Dual Battery Tray Kits	Part #
70-90 CJ & Wrangler, Kit (NEW)	11214.50
91-95 Wrangler, Kit (NEW)	11214.51
97-06 Wrangler, Kit (NEW)	11214.52
07-10 Wrangler, Kit (Coming Soon)	11214.53

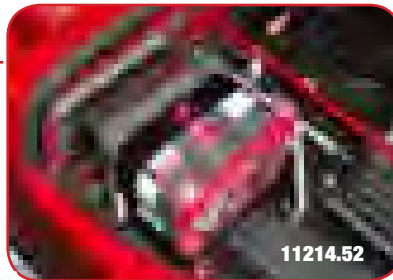

11214.52



Hood Lift Kits

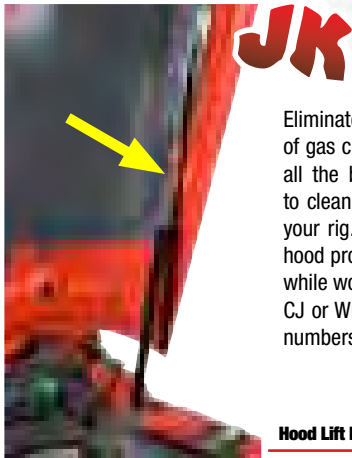

Eliminate the factory prop rod with a pair of gas charged hood lifts. This kit includes all the brackets and gas shocks needed to clean up the underhood appearance of your rig. This kit is also functional as the hood prop rod will no longer be in the way while working underneath the hood of your CJ or Wrangler. Easy installation. Two part numbers cover 72-10 CJ & Wrangler.

Hood Lift Kit	Part #
07-10 Wrangler, Kit	11252.51
72-06 CJ & Wrangler, Kit	11252.50

Solid Rocker Guards

Heavy-duty rocker panels are designed to provide maximum protection for your Jeep's most vulnerable points. Manufactured from 3/16" thick steel plate with a tough black textured finish, these heavy duty rockers can take a beating. Each features cutouts for use with offroad jack and a 2" step for easy access. To protect your vehicle's finish rubber gaskets are utilized to seal and protect the paint and body. For use with most aftermarket fender flares. Two part numbers cover 97-06 Wrangler and Wrangler Unlimited.

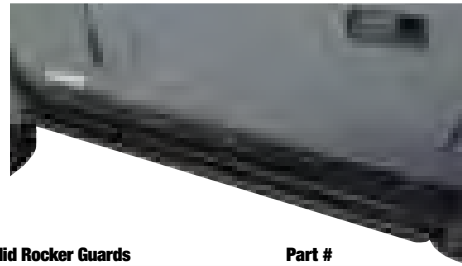

Solid Rocker Guards	Part #
97-06 Wrangler, Pair (NEW)	11504.15
97-06 Wrangler Unlimited, Pair (NEW)	11504.16

Heavy-Duty Tow Hook Kits

11236.06 Heavy-Duty Tow Hook Kit, 93-98 Grand Cherokee



11236.05 Heavy-Duty Tow Hook Kit, 84-01 Cherokee

Don't get your Cherokee or Grand Cherokee stuck on trails without a Rugged Ridge Heavy-duty XJ or ZJ Tow Kit on the front. The 1/4 inch thick steel plate is form bent for maximum strength then powder coated for protection from the elements.

Heavy-Duty Tow Hooks	Part #
84-01 Jeep® Cherokee, Pair	11236.05
93-98 Jeep® Grand Cherokee, Pair	11236.06

Heavy-Duty Transfer Case Crossmember

The Rugged Ridge Heavy-duty Transfer Case Crossmember is made of 3/16" steel, welded, reinforced and powder coated black to protect the underbelly of your XJ from the elements.



Heavy-Duty Transfer Case Crossmember	Part #
84-01 Jeep® Cherokee, Each	12035.60

Off Road Jack Mount



11586.01

JK Off-Road Jack Mount allows you to carry your Off-Road jack on the outside of your vehicle saving precious cargo space. Fast and easy bolt on installation. Compatible with stock and most aftermarket rear bumpers (without tire carriers) as well as Rugged Ridge XHD rear bumper with or without tire carrier. Bracket is sturdy and secures the jack in two locations to eliminate any vibration noise during vehicle operation. Durable textured finish looks great. Fits most off-road style jacks including Hi-Lift™.

Each Jack mount incorporates a special round cutout for padlock use.

NEW!



Fits All Original Equipment And Rugged Ridge XHD Rear Bumpers

Quick Release Knob Allows For Easy Jack Attachment/Removal

Off Road Jack Mount

Part #

Off Road Jack Mounting Bracket, Hi-Lift Style, Jeep Wrangler (JK) 07-10, Pair (NEW)

11586.01

Heavy Duty Tire Carrier Mount

If you have installed larger tires on your rig then a matching spare tire is a must. The problem comes when you try to bolt that new monster tire/wheel combo on your factory spare tire mount. Rugged Ridge has the answer with the HD Tire carrier Mount. The HD Tire Carrier Mount is constructed of heavy 1/4" steel plate and mounts to the tailgate. The tire is relocated two inches up and out from the old mount for larger tire clearance (Maximum tire size=35").

Heavy-Duty Tire Carrier & Spacer

11585.01 Textured Black, 87-06 Wrangler, Each

CAUTION: The tire carrier mount is designed to fit tires 35" in diameter or less.



11585.01 Tire Carrier Mount, Textured Black, 76-06 CJ/Wrangler

Heavy Duty Tire Spacer

The Spare Tire Spacer bolts to your existing factory spare tire mount and relocates the tire two inches up and out. Both the HD Tire Carrier and Spare Tire Spacer feature 5x4.5" and 5x5.5" wheel bolt patterns and tough powder coated black textured finish. Caution: The tailgates on 07-10 Wrangler models are not designed to hold extra large tires. Therefore, do not use a tire larger than a 33x12.50" or equivalent tire with this spacer. If you want to carry a larger tire, we recommend using the XHD Rear Bumper with Tire Carrier (Only for JK 07-10)

Heavy-Duty Tire Carrier & Spacer

11585.02 Textured Black 76-10 CJ/Wrangler, Each

CAUTION: The tire carrier spacer is designed to fit tires 33" in diameter or less. Do not exceed these tire sizes

11585.02
Tire Carrier Spacer
76-10 CJ/Wrangler



Manual Locking Hubs

Knee deep in mud with a failed automatic hub and a disabled vehicle? The only way to repair it is to replace it. The question is, with what? Factory automatic hubs have a history of failing when you need them most. A damaged hub will render your 4x4 useless and leave you stranded. Wish you could swap your venerable automatic hubs to a set of manual locking hubs? Rugged Ridge has heard your plea. Rugged Ridge Manual Locking Hubs are unanimously recognized as the world's toughest hubs by our thousands of satisfied customers worldwide. Brute strength matters, that is why the bodies of our hubs are crafted from impact resistant nodular iron, and feature a corrosion resistant die cast aluminum cap. Our hubs deliver better 4WD performance when locked and improved fuel economy in 2WD when unlocked, than automatic hubs. Purchasing a set of premium manual hubs is more cost effective than servicing your worn factory hubs. With the money you save you'll be able to carry a spare set, not that you'll need them. Sure you have to get out of the cab to lock the hubs, but unlike automatic hubs you won't have to wait until you lose traction for your four-wheel drive to engage.

Rugged Ridge Premium Hubs Feature:

- A full metal cap and body crafted from impact resistant nodular iron.
- Corrosion resistant die cast aluminum caps coated with high luster epoxy enamel for along lasting finish.
- Better 4WD performance when the manual hubs are locked. Works in reverse and compression braking.
- No slippage or partial engagement / disengagement issues that plague automatic hubs.
- Better fuel economy by freewheeling in 2WD mode. Great for any "tow vehicle".
- Decreases wear on internal components by engaging 4WD only when needed.
- More durable and cost effective than replacing or servicing automatic hubs.
- Ridiculously simple installation. Your average installation is completed in less than 20 minutes.
- Manual hubs offer extra gear ranges. By unlocking your hubs and driving in 4WD mode, you gain use of 2WD Low and 2WD High ranges.
- 1998-00 Ford Ranger (15001.70) application is only available from Rugged Ridge!



Make/ Model	Years	Part #	Spline Count	Bolt Count	Make/ Model	Years	Part #	Spline Count	Bolt Count
Chevrolet / GMC					Jeep®				
Blazer, Jimmy, Suburban	69-91**	15001.18 *	19	Internal Mt.	Wilys CJ2A	46-49	15001.01	10	6
1/2 Ton Pickup Truck	69-87	15001.18 *	19	Internal Mt.	Wilys CJ3A	48-53	15001.01	10	6
3/4 Ton Pickup Truck (NEW)	60-76	15001.17	19	6	Wilys CJ3B	53-64	15001.01	10	6
3/4 Ton Pickup Truck	77-87	15001.18 *	19	Internal Mt.	Wilys M38A1	52-68	15001.01	10	6
1 Ton Pickup Truck (NEW)	76-91**	15001.39	30	Internal Mt.	CJ5 & CJ6	55-71	15001.01	10	6
Geo Tracker (NEW)	89-98	15001.38	26	6	CJ5, CJ6, CJ7	72-80	15001.02	27	6
Grand Vitara (NEW)	99-04	15001.38	26	6	CJ7 & CJ8	81-86	15001.26	27	5
Dodge / Chrysler					Jeepster Commando C101				
1/2 Ton Pickup Truck (NEW)	47-68	15001.17	19	6	Jeepster Commando C104	66-71	15001.01	10	6
1/2 Ton Pickup Truck & Ramcharger	69-75	15001.18 *	19	Internal Mt.	Wagoneer & Gladiator	72-73	15001.02	27	6
3/4 Ton Pickup Truck (NEW)	57-75	15001.17	19	6	Wagoneer & Cherokee (SJ) (NEW)	63-73	15001.01	10	6
Power Wagon WC-50 & WC-60 (NEW)	42-56	15001.08	16	6	J-10 Pickup (NEW)	74-91	15001.18 *	19	Internal Mt.
1/2 Ton Pickup Truck & Ramcharger	80-93	15001.18 *	19	Internal Mt.	J-20 Pickup (NEW)	74-91	15001.18 *	19	Internal Mt.
3/4 Ton Pickup Truck & Ramcharger	80-93	15001.18 *	19	Internal Mt.	Mazda				
3/4 Ton Pickup Truck (NEW)	90-93	15001.39	30	Internal Mt.	B3000 & B4000	01-08	15001.70	27	Internal Mt.
1 Ton Pickup Truck w/Dana 60 (NEW)	90-93	15001.39	30	Internal Mt.	Navajo (NEW)	90-94	15001.65	27	5
Raider (NEW)	87-89	15001.43	28	6	Pickup Truck (NEW)	94-97	15001.65	27	5
Ford					Mitsubishi				
Bronco (Except Bronco II)	66-96	15001.18 *	19	Internal Mt.	Montero	82-92	15001.43	28	6
F100 1/2 Ton	59-86	15001.18 *	19	Internal Mt.	Nissan				
F150 1/2 Ton	59-96	15001.18 *	19	Internal Mt.	Patrol	80-87	15001.23	29	6
F250 3/4 Ton w/Dana 44	59-75	15001.18 *	19	Internal Mt.	Pickup Truck	86-93	15001.29	27	6
F250 3/4 Ton w/Dana 44HD (NEW)	63-77	15001.17	19	6	Frontier V6	90-01	15001.61	28	6
F250 3/4 Ton w/Dana 44	78-86	15001.18 *	19	Internal Mt.	Pathfinder	86-89	15001.29	27	6
F250 3/4 Ton w/Dana 60 (NEW)	78-97	15001.39	30	Internal Mt.	Pathfinder V6	90-01	15001.61	28	6
F350 1 Ton (NEW)	76-97	15001.39	30	Internal Mt.	Xterra	00-04	15001.61	28	6
F250 & F350 Super Duty (NEW)	99-04	15001.39	30	Internal Mt.	Suzuki Sidekick/Geo Tracker				
Ranger	98-00	15001.70	27	Internal Mt.	Samurai & Sierra (NEW)	82-94	15001.38	26	6
Ranger (NEW)	90-97	15001.65	27	Internal Mt.	Sidekick & Vitara (NEW)	89-04	15001.38	26	6
Ranger (incl. 15001.65, 15002.65) (NEW)	90-97	15003.65	27	Internal Mt. Kit	Toyota				
Explorer (NEW)	90-94	15001.65	27	Internal Mt.	Pickup Truck	76-85	15001.21	30	6
Ranger & Bronco II (NEW)	83-89	15001.67	23	5	4 Runner	76-85	15001.21	30	6
International					Pickup Truck, T100 (NEW)				
Scout	60-71	15001.01	10	6	4 Runner (NEW)	86-95	15001.13	26	6
Scout II, Terra, Traveler	72-80	15001.02	27	6	Tacoma*** (NEW)	95-00	15001.13	26	6
1/2 Ton Pickup Truck (NEW)	56-67	15001.17	19	6	Dana 70				
3/4 Ton Pickup Truck (NEW)	56-67	15001.17	19	6	Dana 70 Hub (NEW)		15001.97	35	Internal Mt.
1/2 Ton Pickup Truck (NEW)	68-75	15001.18 *	19	Internal Mt.	Other Components				
Travelall (NEW)	68-75	15001.18 *	19	Internal Mt.	Service Kit for 15001.65 Hub (NEW)		15002.65		
Isuzu					Service Kit for 15001.18 Hub (NEW)		15002.18		
Trooper II (NEW)	87-99	15001.33	17	6	***Replaces OE manual hubs)				
Rodeo (NEW)	91-99	15001.33	17	6					
Amigo (NEW)	91-99	15001.33	17	6					

* Some models converting from automatic hubs may require service kit for installation.

** All Chevrolet pickup trucks built in 1988 were equipped with an automatic hub system which cannot be converted.

Part #'s 15001.39, .97, .13, .17, .67 & 15002.18 available 2010.

Transfer Case Slip Yoke Eliminator Kit/CV Drive Shafts



18676.72 Mega Short Slip Yoke Eliminator Kit

This kit is a MUST if you installed a 2" or taller suspension lift in your 1987-2006 Wrangler (not needed for body lifted Jeeps®). The kit fits all 1987 and up NP 231 transfer cases. A Slip Yoke Eliminator Kit (SYE) will eliminate the need to drop your transfer case in order to avoid drive train vibrations that are caused by taller suspension lift. The purpose of this kit is to replace the slip yoke portion of the NP 231 with a fixed yoke and CV-style drive shaft assembly. The Mega Short SYE (18676.72) is designed to be used in the same lift applications as the other standard SYE kit (2" and up). The main advantage to the new Mega Short SYE is that it allows for a much longer drive shaft to be used (additional 3"). This reduces drive shaft angle, improves bearing & U-joint life, reduces driveline vibrations. It also has a shorter and stronger main shaft design with improved oiling. Will not work with cable driven speedometers. Not for use with Rubicon models.



18676.60 Slip Yoke Eliminator Kit

Transfer Case Slip Yoke Eliminator Kit	Part #
87-06 Wrangler Slip Yoke Eliminator (with NP231 transfer case) *, Kit	18676.60
87-06 Wrangler Mega Short Slip Yoke Eliminator with Vehicle Speed Sensor (with NP231 transfer case) *, Kit	18676.72
87-06 Wrangler Mega Short Slip Yoke Eliminator without Vehicle Speed Sensor (with NP231 transfer case) *, Kit	18676.70
Speed Sensor for Mega Short Slip Yoke Eliminator Kit #18676.70, Each	18676.71
Replacement Bearing for Mega Short Slip Yoke Eliminator Kit #18676.70, Each	18676.74

CV Equipped Drive Shafts	Part #
87-93 Wrangler with up to 3" Lift, Rear, Each	16592.01
87-93 Wrangler with over 3" Lift, Rear, Each	16592.02
94-95 Wrangler with up to 3" Lift, Rear *, Each	16592.03
94-95 Wrangler with over 3" Lift, Rear *, Each	16592.04
97-06 Wrangler with 2"-6" Lift, Rear, Each	16592.05
97-06 Wrangler with 3.5"-6" Lift, Rear (for Mega Short SYE only), Each	16592.06
07-10 Wrangler 2-Door or 4-Door, Front, Each	16592.22
07-10 Wrangler 2-Door, Rear, Each	16592.21
07-10 Wrangler 4-Door, Rear, Each	16592.20

JK



16592.06 CV Equipped Drive Shaft for 97-06 Wrangler

WARNING

WARNING: OEM slip yokes on 1987-2006 Jeep® Wrangler are not suitable for use with 2" or taller Rugged Ridge™ or other vendors' suspension lifts. Failure of slip yoke may result in damage to transfer case and/or loss of vehicle control. Use of this slip yoke eliminator kit is required for all suspension lifts 2" or taller. See additional product safety information and WARNINGS at back of catalog.

*See page 221 for NP231 Transfer Case Parts

Lower Control Arm Mounts for 1997-06 Wrangler

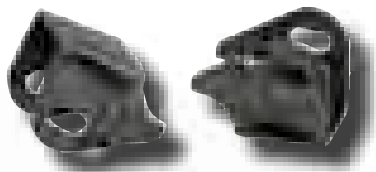

Designed to replace and upgrade the weak OE front lower control arm mounts on 1997-06 Wranglers. These heavy-duty weld-on brackets provide a secure mount when driving off road. Greater wall thickness combined with a welded alignment cam provide extra support to the axle.

Lower Control Arm Mount	Part #
Lower Control Arm Mount, 97-06 Wrangler, Pair	18273.01

Heavy-Duty Steering Box Mount



18003.10 Heavy-Duty Steering Box Mount

This overbuilt mounting system eliminates the two piece original equipment version that is prone to fatigue and cracking. With this mount, we have integrated a clamshell frame plate eliminating any potential weak points. Each kit is complete with all hardware and installation instructions. This is the last steering box mount you'll ever need to buy!

Heavy-Duty Steering Box Mount	Part #
76-86 CJ w/power steering, Kit	18003.10

Heavy-Duty Steering Box Brace

Heavy-duty design supports your steering box during those offroad adventures. Easy to install bolt on design.



HD Steering Box Brace	Part #
76-86 Jeep® Each	18021.02
84-01 Cherokee, Each	18021.05

Heavy-Duty Steering Kits & Components

Beef up your ride with Rugged Ridge steering components. This is a bolt-on solution for preventing bent tie rods from wheeling with larger tires. The tubes are 1-1/4" ID SAE 1018 steel that is cold rolled, pierced, and drawn through dies to produce a wall thickness of 1/4". This is true DOM tubing with no seams or welds to fail. Heavy-duty 7/8" rod ends feature standard tapered ends to fit stock knuckle applications. You get one ton strength without any modifications to your steering knuckles. The Heavy-Duty Crossover Steering Conversion Kit replaces the bump-steer prone inverted Y-type steering system. This kit connects the drag link to the end of the tie rod at the wheel, giving a better steering angle and better leverage. If your vehicle is lifted a crossover steering system is a must!

**.25" Thick
1.25" O.D.**

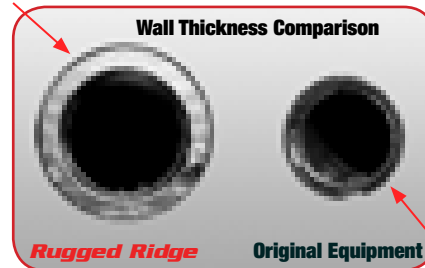

**.125" Thick
.625" O.D.**

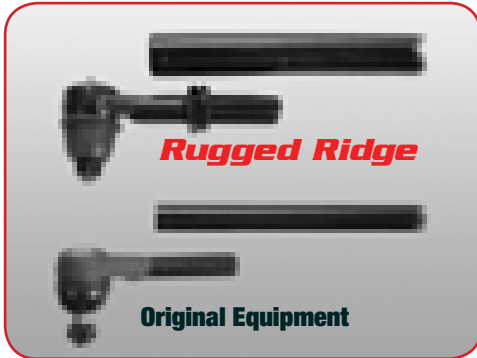

Rugged Ridge Heavy-Duty Tie Rods compared to Original Equipment



Heavy Duty Crossover steering systems prevent "bump steer"!



HD Tie Rod Ends Included

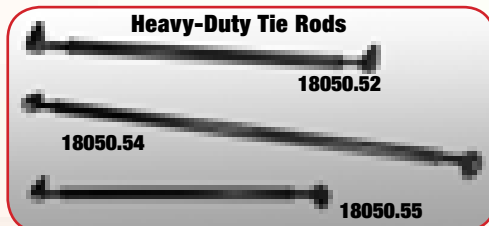

Heavy-Duty Kits

	Part #
Complete Heavy-Duty Crossover Steering Conversion Kit (Includes 4 Tie Rod Ends & Steering Dampener Bracket) 97-06 Wrangler, 84-01 Cherokee (w/under 4" lift), 93-98 Grand Cherokee (6 Cylinder only)	18050.82
Complete Heavy-Duty Tie Rod and Drag Link Kit (Includes 4 Tie Rod Ends) 72-83 CJ5, 72-77 CJ6, 76-81 CJ7, CJ8 Narrow Track (#18050.54 & #18050.56)	18050.80
Complete Heavy-Duty Tie Rod and Drag Link Kit (Includes 4 Tie Rod Ends) 82-86 CJ7 & CJ8 Wide Track (#18050.53 & #18050.55)	18050.81
Complete Heavy-Duty Tie Rod and Drag Link Kit (Includes 4 Tie Rod Ends) 87-95 Wrangler	18050.83

* Not recommended for stock height suspensions

Heavy-Duty Steering Components

	Part #
Heavy-Duty Tie Rod (Includes 2 Tie Rod Ends) 97-06 Wrangler, 84-01 Cherokee, 93-98 Grand Cherokee (6 Cylinder Only), all with stock steering linkage only, not for use with kit #18050.82, Each	18050.51
Heavy-Duty Tie Rod (Includes 2 Tie Rod Ends) 82-86 CJ7 & CJ8 Wide Track, Each	18050.53
Heavy-Duty Tie Rod (Includes 2 Tie Rod Ends) 72-83 CJ5, 72-77 CJ6, 76-81 CJ7, CJ8 Narrow Track, Each	18050.54
Heavy-Duty Drag Links (Includes 2 Tie Rod Ends) 87-95 Wrangler with stock steering linkage only, not for use with kit #18050.83, Each	18050.52
Heavy-Duty Drag Links (Includes 2 Tie Rod Ends) 82-86 CJ7 & CJ8 Wide Track, Each	18050.55
Heavy-Duty Drag Links (Includes 2 Tie Rod Ends) 72-83 CJ5, 72-77 CJ6, 76-81 CJ7, CJ8 Narrow Track, Each	18050.56
Heavy-Duty Tie Rod, Cross Over 1987-95 Wrangler(for use in kit #18050.83), Each	18043.28
Heavy-Duty Tie Rod Steering Dampner Bracket (for use in kit #18050.82), Each	18040.50

Heavy-Duty Tie Rod Ends

	Part #
Heavy-Duty Tie Rod End 7/8", Left Hand Thread, Each	18043.10
Heavy-Duty Tie Rod End 7/8" Right Hand Thread, Each	18043.26
Heavy-Duty Tie Rod End With Drag Link Connection, 7/8" Left Hand Thread, Each	18043.27

Front Adjustable Track Bar & Frame Stiffener



18205.20 Track Bar/Frame Stiffener Kit

The Adjustable Track Bar's function is to properly locate and center the front axle under the body of your Jeep® and improve its handling capabilities and steering geometry. This kit is designed to correct misalignment that can develop with Jeeps® with 4" of lift. Our track bar tubes are constructed with the same beefy 1.25" OD x.25" wall DOM tubing found in our Heavy Duty Tie Rod Kits! The bar is powder coated black to prevent corrosion and includes: polyurethane bushings, heavy duty mounting bracket and features a 7/8" zinc plated rod end. This a great companion to our 84-01 XJ and 93-98 ZJ Heavy Duty Crossover Steering Kit #18050.82. For the ultimate in front end rigidity add on our Frame Stiffener #12035.51. This piece ties the front frame rails together while bracing the track bar mount. It is specifically designed for use with the Adjustable Track Bar (#18205.03) only.

Front Adjustable Track Bar and Frame Stiffener	Part #
Front Adjustable Track Bar, 84-01 Cherokee XJ, 93-98 Grand Cherokee *	18205.05
Frame Stiffener, 84-01 Cherokee XJ, 93-98 Grand Cherokee **	12035.51
Track Bar/Frame Stiffener Kit (consists of 18205.05 & 12035.51)	18205.20

* For use with 4" & over lifts

**Can only be installed in conjunction with P/N 18205.05



12035.51 Frame Stiffener

18205.05 Adjustable Track Bar

RRC Tubular Flat Fenders



These over-built tubular fenders were designed for maximum suspension articulation while still maintaining a factory-style inner fender liner. Tough 0.120" wall tube is attached to 1/8" steel plating for one tough fender design. RRC Tubular Flat Fenders are direct factory replacements with a built in full fender liner (some drilling may be required) allowing for all factory engine accessories to be mounted by using the factory mounting hardware. Fenders are packed in pairs, primed for paint. Though these flares cover most tires, they are designed for offroad use and additional flare coverage may be needed for onroad use in some states. Two unique styles to choose from: Basic model requires greater installation (drilling) and more sheet metal work before painting. It also includes the side marker light housing. Upgrade model bolts directly on using factory inner liner has ground welds and is ready for paint. The upgrade version does not include the side marker light housing and is designed for offroad use only.



Part #	Description
12004.61	Basic Flat Fender, 97-06 Wrangler, Primer, Pair
12004.53	Upgrade Flat Fender, 97-06 Wrangler, Primer, Pair
12004.60	Basic Flat Fender, 87-95 Wrangler, Primer, Pair

NEW!



16919.30

HD Clutch Link Kit

Replaces the factory style L-bracket with retainer clip clutch rod with an up-graded spherical rod design. Allows for full clutch engagement during heavy body and frame flex situations while off road, where the factory design has tendencies to bind not allowing you to get into gear. Also can be used with up to 3" body lifted vehicles replacing the shorter factory clutch rod.

HD Clutch Link Kit	Part #
1976-83 CJ5, 1976-86 CJ7, 1981-86 CJ8. Stock - Up To 3" Body Lift. (NEW)	16919.30

Hood Lock

Special design virtually disappears into the grill. Cam lock design keeps people out of the engine compartment of your Jeep®. These clever applications install in minutes. An upgraded internal lock cover keeps ice and debris from fouling the lock mechanism.



11252.01 Hood Lock, 1972-86 CJ

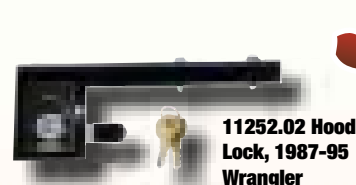

11252.02 Hood Lock, 1987-95 Wrangler



11252.03 Hood Lock, 1997 Wrangler



11252.04 Hood Lock, 1998-06 Wrangler



11252.05 Hood Lock, 2007-10 Wrangler

Hood Lock Kits	Part #
07-10 Wrangler, Each	11252.05
98-06 Wrangler, Each	11252.04
97 Wrangler, Each	11252.03
87-95 Wrangler, Each	11252.02
72-86 Jeep® Each	11252.01

JK

HID Off Road Lighting

We mated the brilliance of High Intensity Discharge bulbs with the rugged construction of our traditional halogen off road lights. The result is more efficient and powerful beam better capable of illuminating the night sky. HID lights are 2½ times more powerful than halogen lights and draw 60% less current than a standard 100W fog light. Our 6" and 5" HID Lights are constructed with heavy duty stamped steel housings, and are available in corrosion resistant black or stainless steel finish. Rugged Ridge lights feature waterproof connections, internal ballast, and a reinforced multi-directional mounting base. The lights are available individually or in kits containing a pre-terminated wiring harness, relay, impact resistant stone guards and illuminated dash switch.

- 5", 6", 7" HID light assemblies available.
- 12V 35W 4200K HID Bulb.
- Internal ballast - no external ignition ballast to install.
- 2½ times more powerful than halogen bulbs.
- Draws 60% less current than a standard 100W fog light.
- HID Lights include impact resistant stone guard.
- The average life of an HID bulb is 2000 hours, compared to 500-1000 hours for a halogen unit.



Lights are available individually.
All include impact resistant stone guards

All HID lights are available in 3 packs for use with Rugged Ridge Light Bars

Kits include a pre-terminated wiring harness, relay and illuminated dash switch



15206.01



15205.63



15205.51

NEW!

HID Off Road Lighting	Single Light	2 Light Kit w/ Wiring Harness	3 Light Kit w/ Wiring Harness
6" Round, Black (NEW)	15205.01	15205.51	15205.61
5" Round, Black (NEW)	15205.02	15205.52	15205.62
7" Round, Black, Plastic (NEW)	15205.03	15205.53	15205.63
5" Round, Black, Plastic (NEW)	15205.04	15205.54	15205.64
6" Round, Stainless (NEW)	15206.01	15206.51	15206.61
5" Round, Stainless (NEW)	15206.02	15206.52	15206.62



Don't Forget a Rugged Ridge Light bar or XHD bumper with built in light tabs!

DON'T LET NIGHT FALL ON YOUR ADVENTURE.
 CREATE YOUR OWN DAYLIGHT LONG AFTER THE SUN HAS GONE DOWN!

**STANDARD
 HEADLIGHTS**

LOWER LIGHT OUTPUT IDEAL FOR CITY DRIVING

VS.

**BUMPER
 MOUNTED
 HID LIGHTS**

EXTREME OUTPUT TO LIGHT UP THE TRAILS

NEW!



HID Light Accessories



15210.50
 Black Lens

15210.8
 Replacement HID Bulb
 for 7" Lights

15210.80
 Replacement HID Bulb
 for 5" & 6" Lights

Accessories/Replacement Parts

Accessories/Replacement Parts	Part #
HID Lighting Covers, 7", Smoked (NEW)	15210.51
HID Lighting Covers, 6", Black (NEW)	15210.50
HID Lighting Covers, 5", Black (NEW)	15210.52
HID Lighting Installation Harness for a pair of lights (NEW)	15210.60
HID Lighting Installation Harness for three lights (NEW)	15210.61
Replacement HID Bulb for 5" and 6" lights (NEW)	15210.80
Replacement HID Bulb for 7" lights (NEW)	15210.81

Halogen Off Road Lighting

Designed, engineered, and tested to stand up to the rigors of off road use, our lights are constructed with heavy-duty stamped steel housings, and crystal glass lenses set in shock absorbent weatherproof rubber gaskets. The brilliant 12V 100 watt halogen bulbs slice through fog, rain or snow to help illuminate the road even under the toughest conditions. Available in Round, Rectangular and Slim housings in either a black or stainless steel finish to best suit your application. Slim lights feature a narrow profile just 2 13/16" thick! This sleek design allows them to be mounted in places most lights won't fit. They are perfect for windshield and grille mount light systems. The lights are available individually or in kits containing a pre-terminated wiring harness, relay, impact resistant stone guards (white stone guards with stainless, black with black) and illuminated dash switch.



NEW!
15207.51

Rugged Ridge Off Road Lights, 100W	Single Light	2 Light Kit w/ Wiring Harness	3 Light Kit w/ Wiring Harness
6" Round, Black (NEW)	15207.01	15207.51	15207.61
5" x 7", Black (NEW)	15207.05	15207.55	15207.65
6" Slim, Black (NEW)	15207.10	15207.58	15207.68
6" Round, Stainless (NEW)	15208.01	15208.51	15208.61
6" Slim, Stainless (NEW)	15208.10	15208.58	15208.68



Crystal glass lenses set in shock absorbent weatherproof rubber gaskets.

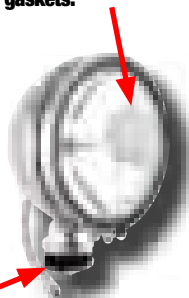

Multi-directional mounting base allows you to focus light where you need it the most.



Each light includes an impact resistant stone guard.

Slim lights feature a narrow profile - just 2 13/16" thick!



Rectangular lights give your vehicle a whole new look

Halogen Light Accessories

Part #	
15210.53	Off Road Light Cover, 6-Inch Black, Ea. (NEW)
15210.54	Off Road Light Cover, 6-Inch White, Ea. (NEW)
15210.55	Off Road Light Cover, 5x7-Inch Black, Ea. (NEW)
15210.56	Off Road Light Cover, 5x7-Inch White, Ea. (NEW)
15210.57	Off Road Light Cover, 6-Inch Black Slim, Ea. (NEW)
15210.58	Off Road Light Cover, 6-Inch White Slim, Ea. (NEW)
15210.62	Off Road Light Installation Harness, For Pair Of Lights, Ea. (NEW)
15210.63	Off Road Light Installation Harness, For Three Lights, Ea. (NEW)
15210.82	Halogen H3 Off Road Light Bulb, 100w Replacement, Ea. (NEW)
15210.83	Halogen H3 Off Road Light Bulb, 130w Replacement, Ea. (NEW)

Windshield Hinge Light Brackets

Special black powder coated or polished stainless brackets mount directly to the windshield hinge of your CJ or Wrangler. Allows for easy mounting of auxiliary lighting. Each bracket is custom designed for an exact mount and 07-10 models include a rubber gasket to protect the paint during installation/removal. Sold in pairs. Lights not included.



11027.03

Windshield Hinge Light Brackets	Black	Stainless
07-10 Wrangler	11027.03	11028.03
97-06 Wrangler	11027.02	11028.02
76-95 CJ/Wrangler	11027.01	11028.01

Mount A Set Of Driving Lights On Your Hood Catches

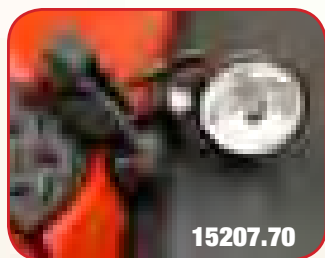

15207.70

Rugged Ridge offers a complete light solution for your 2007-10 Jeep® Wrangler with our NEW Hood Mount Off Road Light Kit. This innovative product mounts a pair of 3" 55-watt Halogen Lights directly to your factory hood latches without drilling or vehicle modification. Each Kit includes textured black powder coated brackets, two 3" Halogen lights, a pre-terminated extended wiring harness, relay and an adhesive mounted switch for a complete light solution.



Hood Mounted Off Road Light Kit 2007-10 Wrangler	Part #
Hood Mounted Off Road Lights, 3" Black, 2 Light Kit w/ Wiring Harness (NEW)	15207.70



11232.20, 2007-10 Wrangler

JK

Front Bumper Light Bars

Rugged Ridge has engineered a durable and easy to install light bar that allows you to add auxiliary lighting to your factory Wrangler bumper. The light bar bolts to existing mounting holes and installs easily without cutting, drilling, or removing the bumper. With a few simple hand tools you will be able to install your light bar and mount up to three lights on your Jeep® while retaining your factory bumper. Lights not included.



11232.02,
1997-06 Wrangler



11138.20, 2007-10 Wrangler

Front Bumper Light Bars

07-10 Wrangler, Textured Black, Each
07-10 Wrangler, Stainless Steel, Each
97-06 Wrangler, Textured Black, Each
97-06 Wrangler, Stainless Steel, Each

Part

11232.20
11138.20
11232.02
11138.02

Rugged Ridge JK Windshield Light Bar

The Ultimate Light Bar for your Wrangler! This exciting new design has been created to give the durable look of a five tab light bar with features found nowhere else. Through extensive testing, this heavy duty light bar incorporates a special wind deflector below the light bar to dramatically reduce whistling and "buffeting" of your soft top. Each bar hugs the contour of your windshield providing a great look while not interfering with the use of your hard or soft top. Oversized 2" textured black tubing attaches to your windshield mounts with no drilling. Each Light bar has five light tabs for use with Rugged Ridge Lighting options (fits up to five 7" lights). Each light bar has been specially developed to work with Rugged Ridge Light mount brackets and/ or Rugged Ridge mirror relocation brackets. Special three piece design makes the packaging small for ease of shipping. This is truly the most advanced light bar on the market!



11232.21

Windshield Light Bar

Textured Black, Jeep Wrangler (JK) 07-10, Each (NEW)

Part

11232.21

TJ Light bars

Stainless Steel, Each
Black, Each

Part

11138.01
11232.21

NEW!

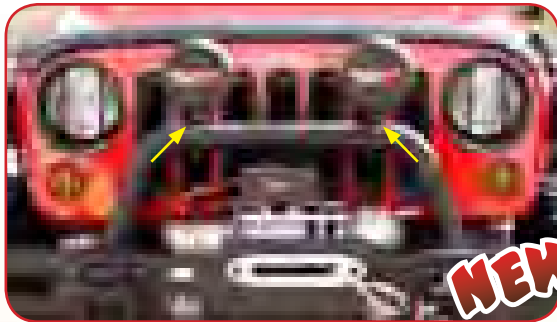

NEW!

XHD Overrider Light Clamps

Light mount brackets for use with XHD part numbers 11540.14, 11540.16 and any other 2"-2.5" bumper overrider/tubes. Easy mount design makes these a must for mounting Rugged Ridge Lights to your bumper. Also available for smaller ATV/UTV 1.5"-1.75" tube sizes. Sold as eaches.

Light Clamps

2"-2.5" (NEW)
1.5"-1.75" UTV Sport Bar Light Mount Bracket (NEW)

Part

11503.82
11503.83

OE JK Fog Light

Stock replacement lens and housing assembly. Fits either side.

OE Fog Light

Fog Light Assembly, Jeep Wrangler (JK) 07-10 LH/RH

Part

12407.12



Stainless Steel Cat-Back Exhaust System

Open up your Jeep's® exhaust with this great looking and long lasting stainless steel exhaust system. You'll get a mellow exhaust note that will set your rig apart. The 2-1/4" mandrel bent pipes give hot exhaust gases a smooth exit without the constrictions found in crush-bent pipes. This is a bolt-on system that installs after the catalytic converter to keep you emissions legal. The dual split exits feature slash cut and rounded oval tips for a tough look. Includes all necessary mounting hardware.



Stainless Steel Cat-Back Exhaust System	Part #
07-10 Wrangler 2-Door & 4-Door, Kit (NEW)	17606.75

Cat-Back Exhaust System

Rugged Ridge has built the most rugged exhaust system available for your Jeep®! Our catback systems feature mufflers, stainless steel hardware, and mandrel bent aluminized pipes. Our mufflers are constructed from heavy-duty 14-gauge aluminized steel, are seam welded, and feature reinforced inlets and outlets. Not only will you gain performance and a deep throaty sound, you'll have the toughest exhaust system money can buy.



Cat-Back Exhaust System	Part #
07-10 Wrangler, Kit	17606.55
01-06 4.0L, 01-02 2.5L, 03-06 2.4L Wrangler, Kit	17606.50
97-00 4.0, 2.5L Wrangler, Kit	17606.51
91-96 4.0, 2.5L Wrangler, Kit	17606.52
99-04 4.7, 4.0L Grand Cherokee, Kit	17606.53
02-06 2.4, 3.7L Liberty, Kit	17606.54
Mufflers	Part #
91-06 4.0L Wrangler, 97-02 2.5L Wrangler, 03-06 2.4L Wrangler, 91-01 Cherokee, Each	17609.22
99-04 4.7L Grand Cherokee, Each	17609.21

Stainless Headers for 2007-10 Wrangler

Our custom Exhaust Headers are engineered to deliver improved performance. The 3.8L isn't a bad motor it just needs more air to "breathe" properly. Our headers increase exhaust gas exit velocity to move more air through the cylinder head's combustion chamber resulting in performance gains. They are constructed of 409 stainless steel to ensure a long operating life. Each complete kit includes manifolds, gaskets, hardware, clamps and easy to read instruction sheets.

Stainless Steel Headers	Part #
2007-10 Wrangler w/3.8L Engine, Each (NEW)	17650.53



Rugged Ridge Headers

These high quality Rugged Ridge headers are available in four finishes: polished 304 stainless steel, non-polished 409 stainless steel, high temperature metallic black ceramic and black painted for a long operating life. All Rugged Ridge designs are extra tough for extreme usage. Flanges are welded 360 degrees to stand up against the hottest conditions. Our polished stainless design gives your engine that new, hot look. Our ceramic coating look great and protects against corrosion & thermal fatigue while increasing horsepower and extending the life your of header. Ceramic headers retain heat better than their chrome or stainless counterparts. Retaining exhaust heat improves air density in the cylinder head's combustion chamber for enhanced air flow. This improved flow increases the exhaust gas exit velocity, and cuts down on your under hood temperature, resulting in performance gains. Each complete kit includes manifold, gasket, hardware and down pipe flange gasket and is backed by a three year limited warranty against corrosion. 97-99 models re-use the factory head pipe. The complete bolt on kit includes manifold, gasket, hardware and down pipe flange gasket. All Rugged Ridge headers come with a limited 6 month/6,000 mile warranty.

17650.51 Header, Polished 304 Stainless, 1991-99 Wrangler with 4.0L engine



17660.02 Header, Steel 1991-98 Wrangler with 4.0L engine



17650.01 Header, 409 Stainless, 1991-98 Wrangler with 4.0L engine

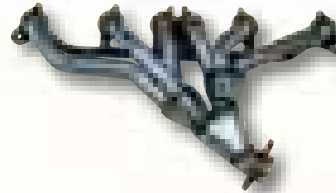

17651.02 header, Black Ceramic 2000-06 Wrangler with 4.0L engine



All Rugged Ridge headers come with gaskets



	Steel	Ceramic	409 Stainless	Stainless
91-98 Wrangler w/ 4.0L Engine, Each	17660.01	17651.01	17650.01	17650.51
00-06 Wrangler w/ 4.0L Engine, Each	17660.02	17651.02	17650.02	17650.52

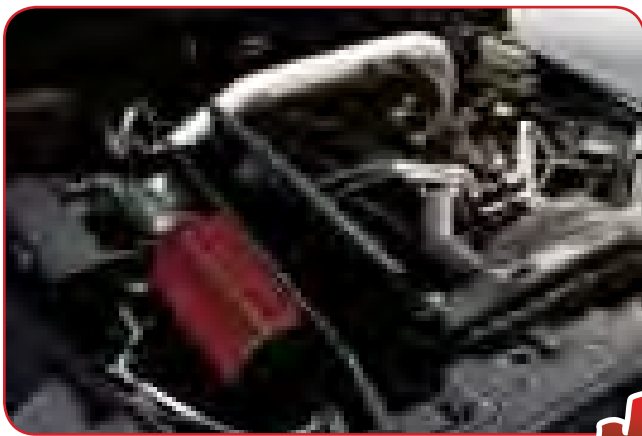

JK



17750.06 for 2007-10 Wrangler 3.8L

17750.01 for 1997-06 Wrangler 4.0L

Cold Air Intakes for Jeep®

Want more horsepower, better throttle response, and improved acceleration?

A Rugged Ridge Cold Air Intake System can boost your performance, while helping you keep extra cash in your wallet. Our polished aluminum mandrel bent intake tube replaces the restrictive factory air box to help improve fuel economy. A black powder coated heat shield separates the filter from engine heat, dirt and debris, as cold air is drawn through a high-flow conical air filter. Unlike other reusable air filters, our dry panel design never needs oiling, which keeps your mass airflow sensor from being damaged by excess oil! The simple bolt on installation gives you power you can feel, adding up to 10HP and 12ft lbs or torque, depending on application.

- Polished mandrel bent 6063 aluminum air intake tube.
- Simple no-drill installation bolts on using simple hand tools.
- Includes a high-flow conical dry panel filter that never needs oiling.
- Intake kit includes black powder coated heat shield
- Part # 17750.01 for 97-06 4L wranglers include a throttle Body Spacer as a part of the kit.
- Improves fuel economy up to 10%*
- Adds up to 10HP and 12ft lbs or torque**

Rugged Ridge Cold Air Intake Systems

Part #

2007-10 Wrangler 3.8L (NEW)	17750.06
1997-06 Wrangler 4.0L (NEW)	17750.01
2003-06 Wrangler 2.4L (NEW)	17750.03
1997-02 Wrangler 2.5L (NEW)	17750.02
1991-95 Wrangler 4.0L (NEW)	17750.04
1991-95 Wrangler 2.5L (NEW)	17750.05
1991-01 Cherokee 4.0L (NEW)	17750.20
1993-98 Grand Cherokee 4.0L w/o ABS (NEW)	17750.20
1993-98 Grand Cherokee 5.2L, 5.9L (NEW)	17750.22

*See <http://www.fueleconomy.gov/feg/maintain.shtml>

** Depending on kit



17750.01 1997-06 Wrangler 4.0L



Throttle Body Spacer

The Rugged Ridge Throttle Body Spacer raises the throttle body 1" above the intake manifold. The lift helps optimize power and performance by drawing in colder denser air. The large bore design allows your system to inhale a larger volume of air producing more horsepower and torque. It features solid aluminum construction with a slick anodized black finish, and is a bolt on performance adder for both 4.0L and 2.5L engines.

- Solid Aluminum Construction.
- Simple no-drill installation bolts on using simple hand tools.
- Includes mounting hardware, gaskets and spacers.
- Black Anodized Finish.
- Fits 91-06 Wrangler 4.0L & 91-02 2.5L & Cherokee 91-01 4.0L & 91-00 2.5L

NEW!



Throttle Body Spacer

Part #

1991-06 Wrangler 4.0L & 91-02 2.5L, 1991-01 Cherokee 4.0L & 1991-00 2.5L (NEW)

17755.01



11237.10 Lockable Spare Tire Mount Bike Carrier

Lockable Spare Tire Mount Bike Carrier

This easy-to-use bike rack mounts to any emergency tire mounting studs. The bike rack carries 2 bikes directly off the spare tire. It is constructed of 2" powder coated steel tubing for maximum rust protection and durability. The bike clamp feature rubber pads to protect your bike's finish. The carrier comes with 2 keys for the locking mechanism. Fits wheel off sets from 2-5/8" to 6". For All Jeep® Outside Spare Tire Applications

Bike Carrier	Part #
Spare Tire Mount Bike Carrier, Each	11237.10

Easy Load Trail Rack

This clever application provides extra storage right above your spare tire. Carry camping gear, coolers and other necessities far above the ground. The rack tubes are welded and powder coated for extra durability. The new Euro style design makes this item look as good as it performs. You can mount this no-drill-installation rack in no time. Storage capacity is rated at 50 lbs.

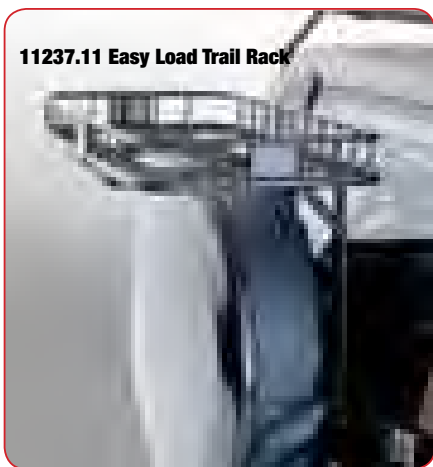

11237.11 Easy Load Trail Rack

Trail Rack	Part #
87-02 Wrangler, Each	11237.11 11237.11

2007-10 Wrangler Receiver Hitch



Custom design bolts directly to factory mounting points on the rear of the vehicle, very similar design to the OE Receiver Hitch. Durable powder coat design sheds water and provides a long lasting rust free finish. Includes cutout for factory wiring harness mounting. Designed as a one-piece welded assembly for added strength, we built our hitch receiver to match the

towing capacity of your Jeep®: 3,500-lb tow rating, 350-lb tongue weight rating with weight distributing equipment; otherwise 2000-lb tow rating, 200-lb tongue weight rating, 2" opening.

Receiver Hitch	Part #
07-10 Wrangler, Each	11580.10

D-Ring, Pair

This heavy-duty zinc coated cast steel construction comes with a 3/4" pin. Perfect for use with all RRC bumpers.



D-Ring	Part #
3/4"D Ring, 9,500lbs, Pair	11235.01 11235.01

Receiver Hitch Extender

Constructed from solid steel the extender lengthens your 2" receiver up to 12 inches! (Hitch mount accessories only - not tow rated)



Receiver Hitch Extender	Part #
12", Each (NEW)	11580.50

2" Receiver Hitch



Includes clip and pin. Ball not included. For Jeep use only. 2000-lb tow rating, 200-lb tongue weight rating.

Ball Mount Receiver Hitch	Part #
2" Square, Each	11237.02

Receiver Tow Hook



Heavy-duty black powder coated tow hook inserts into any 2" style hitch (does not include hitch pin, not designed for towing).

Receiver Tow Hook	Part #
Fits All 2" Receivers, Each	11237.01

Receiver Shackle Bracket

This heavy-duty steel design fits into any 2" receiver box. It is rated up to 9,500 lbs. pulling capacity on evenly distributed straight pulls. NOTE: never exceed your receiver capacity. Not designed for towing. Does not include hitch pin.

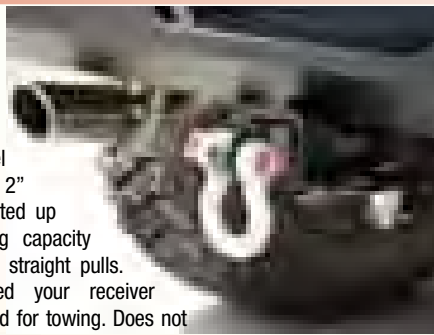

Receiver Shackle Bracket	Part #
All 2" Receivers, Each	11234.01

Hitch Ball

Hitch Ball includes a matching mounting nut and lock washer. Pick from two standard sizes.



Hitch Ball Kit	Part #
2" x 3/4"	11305.01
1-7/8" x 3/4"	11305.02



Designed by a dedicated team of Jeep® enthusiasts, the ORV suspension program is one of the most complete programs available. We have looked at each application in detail to provide the very best and most complete solution for your Jeep®. Since we focus the large majority of our attention on Jeep® vehicles, we know the ins and outs of what the best lift solution is depending on your individual needs. Below is a quick reference guide on the ORV program to make it easier to choose the lift you need for your particular need. Remember, all ORV Kits with shocks include a pair of neoprene wrapped grab handles and an Off Road Organizer for your glove box! **Welcome to ORV™ by Rugged Ridge™!**



A Few Words About Product Safety.

Your safety and the safety of other motorists is very important. Your Jeep® is an off road capable vehicle that readily lends itself to restoration and customization. In considering modifications to your Jeep's® suspension you are the person choosing the combination of suspension, wheels, tires, drive train and accessories that best fit your intended use. Likewise, you are the person responsible for the safety and legality of the vehicle you modify. In modifying your vehicle's suspension, balance your desired off road capabilities against how the vehicle may actually be used off road and on road.

It is not practical or possible to warn about all hazards associated with your Jeep® or modifying your suspension for improved off road capabilities. Start by familiarizing yourself with all vehicle manufacturers' instructions, warnings limited warranties and the instructions and warnings accompanying your aftermarket product. To help you make informed decisions about safety; this catalog and the instructions accompanying our products have provided certain information in the form of "Notices" and "Warnings". This information alerts you to potential hazards that could hurt you or others.

- ▲ NOTICE** This is a caution against anything which may cause damage to the vehicle or its equipment if the caution is ignored. The Notice includes information about how you can avoid or reduce those risks.
- ▲ WARNING** This is a signal telling you that you CAN BE KILLED or SERIOUSLY HURT if you don't follow the Warning. The Warning includes information about what you must or must not do in order to reduce the risk of injury to yourself and others.
- ▲ CAUTION** This is a signal telling you that you or others CAN BE HURT if you don't follow the instruction. The Caution includes information about how you can avoid those risks.

WARNING
HIGHER SOLLVER SEE

Modifying the suspension of your vehicle to improve off road capabilities involves certain risks. The modified vehicle may handle differently than as factory equipped including increased ride-height; reduced lateral stability and risk of roll-over or other accident. Also, owner's choice of larger tire and wheel combinations may require additional braking force or increased stopping distances.

- Failure to drive this vehicle safely may result in serious injury or damage. Avoid sharp turns or abrupt maneuvers. Do not drive the vehicle under any speed or maneuvering conditions which may cause the vehicle to trip, roll, lose traction or compromise your ability to safely brake in an emergency.
- Familiarize yourself with all vehicle manufacturers and Rugged Ridge™ warnings, instructions and limited warranties before driving this modified suspension vehicle. Follow recommended maintenance procedures and routinely inspect your vehicle components for unusual wear or off road damage.
- Rugged Ridge™ does not recommend combined use of body lifts with suspension or other lift devices or modification, alteration or fabrication of any Rugged Ridge™ suspension product to achieve additional lift. Also be aware that most states have restrictions on height modifications for vehicles used on road. Consult your vehicle owners manual, limited warranties, the instructions and warnings accompanying this product and state law before undertaking these modifications or using your modified suspension vehicle on road. A summary of current regulations affecting modified suspension vehicles is available from www.SEMA.org.
- Always wear seat belts and/or appropriate off road restraints, reduce your speed, tread lightly® and safely enjoy your off road vehicle.

KNOW YOUR KITS: Though there are many ways to provide extra lift for your Jeep®, ORV recommends the following lift options as the best way to Lift your Jeep®:

Poly Spacer Kits: Available for Coil Spring Jeep® Wranglers from 97-06 and 99-04 Jeep® Grand Cherokees

Coil Spring Kits: Available for Jeep® Wranglers from 97-10, 93-98 Jeep® Grand Cherokees and 84-01 Jeep® Cherokees

Leaf Spring Kits: Available for Jeep® CJ/Wrangler from 55-95 and 84-01 Jeep® Cherokees

LIFT OPTIONS EXPLAINED:

• **Poly Spacer Kits** - Used for small lifts, these low cost lifts are designed for on road/light off road use only and incorporate the factory coil springs. With the addition of spacers, the ride of your Jeep® will be stiffer than original and provides very little articulation when off road. Bump stops (also called blocks) should always be a part of the kit as you will be using the factory springs. Without the bump stops your spring could over compress or in the case of 07-10 Wranglers, the spring could invert inside itself. These situations can cause a rebound rate that is too great causing a potential mishandling situation or damage your suspension. This method of lifting is the low cost/lower performance solution to lifting your Jeep® vehicle.

• **Coil Lift Kits** - Used for medium to large lifts, these lifts are designed for on road and moderate to severe off road use. Coil Spring kits provide the best way to give extra lift and still maintain OE ride characteristics. The 2" - 4" kits should offer new springs and extended Bump Stops as listed above as well as rear track bar bracket/brace to ensure proper centering of the axle and a secure fit. On 4" kits, it is important have front sway bar disconnects. These important disconnects will provide much more articulation when using your Jeep® off road.

• **Leaf Spring Kits** - Used for all Jeep® CJ/Wrangler vehicles from 1955-1995, these heavy-duty lifts provide a fairly straightforward lift option. The key to any leaf spring lift is the leaf spring itself and prices will vary greatly depending on quality and features. Key "must-have" features that will provide the best ride include: 1.) Teflon inserts between each leaf. These inserts allow each leaf to move independently creating a better ride both on and off road. 2.) Leaf springs should be held together with roller clips and not cinch clips. This method of securing the leaf springs together is more expensive but dramatically improves the vehicles ride and off road performance. 3.) Make sure your leaf springs have built-in degree wedges to help with pinion angle issues. Plus by having a degree wedge already attached, installation of the kit will be easier and there are no extra parts to purchase.



18415.33 Poly Spacer Kit

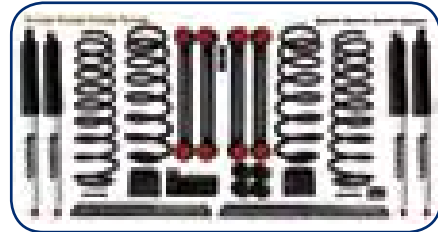

18415.31 Coil Lift Kit

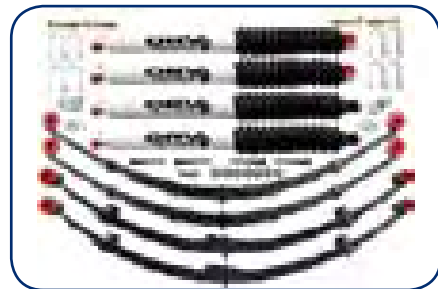

18415.20 Leaf Spring Kit

Coil Spring Kits



Poly Spacer Kits



Leaf Spring Kits

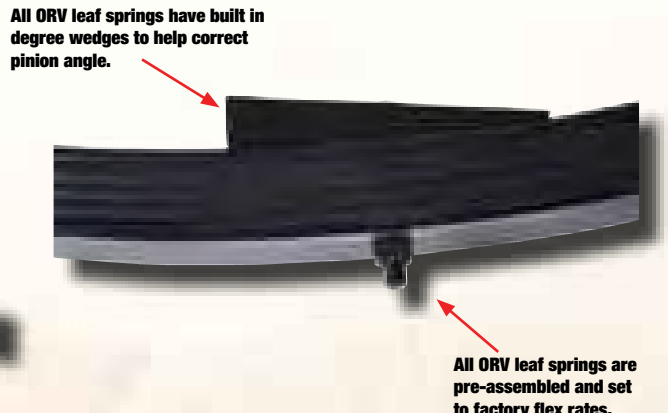

ORV SHOCKS

ORV only uses nitrogen charged gas shocks for all their kits. Though a little more money, the nitro gas shock in combination with the ORV kits provide a better ride both on and off road. By using an ORV lift kit and matching gas shocks, you optimize the suspensions capabilities giving you a better ride both on and off road. Another advantage to Nitro gas shocks is their ability to prevent body roll. This is extremely important, as body roll will kick in the ESP sensors on later model Jeeps®, which will shut the vehicle down.

ORV shock features include:

- 150 PSI pressurized Nitrogen gas
- Internal valving - the internal orifice will rotate when the piston moves more than 2" - automatically adjusts to make the ride as smooth as possible
- Twin tube construction to lower heat build up and protect the shock from off road obstacles
- Constructed to ORV specifications by a leading Shock manufacturer
- Bonded Iron 14mm piston with extra chroming - provides for a longer, rust free life
- Includes polyurethane bushings and a black shock boot
- Limited lifetime warranty on the shocks



The ORV™ Advantage!

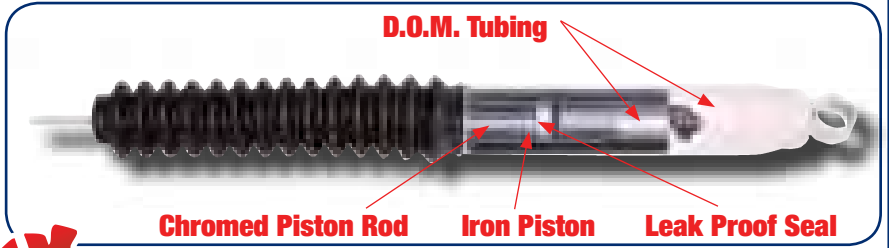

JK

ORV Shocks

	Front	Extended	Collapsed	Rear	Extended	Collapsed
ORV Nitrogen Series Shock, 07-10 Jeep® Wrangler 2-Door, 3.5" Lift, 07-10 Wrangler 4-Door 2.5" Lift	18465.09	22.75"	13.54"	18465.10	25.35"	15.05"
ORV Nitrogen Series Shock, 07-10 Jeep® Wrangler 2-Door, 5" Lift, 07-10 Wrangler 4-Door 4" Lift	18465.11	26.79"	15.56"	18465.12	28.38"	16.65"
ORV Nitrogen Series Shock, 97-06 Jeep® Wrangler, 2" Lift, 04-06 Wrangler Unlimited 2" Lift	18465.05	22.75"	13.54"	18465.06	22.58"	13.71"
ORV Nitrogen Series Shock, 97-06 Jeep® Wrangler, 4" Lift, 04-06 Wrangler Unlimited 4" Lift	18465.07	24.75"	14.54"	18465.08	24.84"	14.82"
ORV Nitrogen Series Shock, 87-95 Jeep® Wrangler, 4" Lift	18465.03	28.75"	16.56"	18465.04	24.84"	14.82"
ORV Nitrogen Series Shock, 87-95 Jeep® Wrangler, 2.5" Lift	18465.09	22.75"	13.54"	18465.02	22.58"	13.71"
ORV Nitrogen Series Shock, 76-86 Jeep® CJ, 2" Lift	18465.14	19.07"	12.07"	18465.02	22.58"	13.71"
ORV Nitrogen Series Shock, 76-86 Jeep® CJ, 4" Lift	18465.02	22.58"	13.71"	18465.01	24.84"	14.82"
ORV Nitrogen Series Shock, 55-75 Jeep® CJ, 4" Lift	18465.01	24.84"	14.82"	18465.01	24.84"	14.82"
ORV Nitrogen Series Shock, 84-01 Jeep® Cherokee XJ, 3" Lift	18465.05	22.75"	13.54"	18465.06	22.58"	13.71"
ORV Nitrogen Series Shock, 93-98 Jeep® Grand Cherokee ZJ 3" Lift	18465.05	22.75"	13.54"	18465.02	22.58"	13.71"
ORV Nitrogen Series Shock, 99-04 Jeep® Grand Cherokee WJ 2" Lift	18465.05	22.75"	13.54"	18465.13	24.84"	14.82"

ORV Steering Stabilizers

Part#

ORV Nitrogen Series Steering Stabilizer, 07-10 Jeep® Wrangler 2 & 4-Door	18475.03
ORV Nitrogen Series Steering Stabilizer, 97-06 Jeep® Wrangler	18475.02
ORV Nitrogen Series Steering Stabilizer, 04-06 Jeep® Wrangler Unlimited	18475.02
ORV Nitrogen Series Steering Stabilizer, 87-95 Jeep® Wrangler	18475.02
ORV Nitrogen Series Steering Stabilizer, 55-86 Jeep® CJ	18475.01
ORV Nitrogen Series Steering Stabilizer, 84-01 Jeep® Cherokee XJ	18475.02
ORV Nitrogen Series Steering Stabilizer, 93-98 Jeep® Grand Cherokee ZJ	18475.02

ORV STEERING STABILIZERS

ORV recommends upgrading your current steering stabilizer or adding a stabilizer on all lifted Jeep® vehicles. The ORV Steering stabilizer dampens out the roughness of the highway and the vibration from running larger tires and wheels. ORV Gas Stabilizers also make it easier to move those larger tires and wheels both on and off road. These noticeable handling improvements are well worth the small investment!





What to Buy:

When looking at which kit is best for your application you need to determine two important things: size of tire and use of vehicle. On the 2007-10 Wrangler JK, 2.5-3.5" coil kit is designed for up to a 34" x 12.5" x 16" tire and moderate off road use. The 4"-5" coil kit is designed for more severe off road use and up to a 35" x 12.5" x 16" tire.

ORV 2.5"-3.5" Coil Spring Lift - With shocks part # 18415.50

- The most complete kit available on the market for JK.
- Includes four powder coated, E-coated 5160H hot rolled bar, 5/8" coil springs that are set to factory rates.
- By using 5160H hot rolled bar, the ORV Springs keep their memory, eliminating any possibility of future sag.
- Setting coil springs to factory rates gives you the best on road ride possible and the ability to use a larger tire.
- Each kit includes a rear track bar brace to strengthen the original track bar mount. An ORV exclusive!
- 4-Door JK's will get on average a 2.5" lift. Two door models will get up to a 3.5" lift. All lifts are dependent on specific Jeep® characteristics and additional parts being put on the vehicle (bumpers, winch, hard tops, soft tops etc.).
- ORV kits with shocks include a pair of Neoprene Wrapped Grab Handles and an Off Road Organizer!



JK 2.5"/3.5" Lift Kit

ORV 4"-5" Coil Spring Lift - With shocks part # 18415.60

- Get off road performance while not sacrificing on road ride.
- Includes 4 powder coated, E-coated 5160H hot rolled bar 5/8" coil springs, set to factory rates for longer life and better ride!
- Each kit includes a rear track bar brace to strengthen the original track bar mount. A must for off road performance on a JK.
- Kit includes sway bar disconnects for more articulation off road.
- ORV uses tough, over built extended control arms for added strength and higher performance. Each arm has a beefy 3/16" wall thickness and each end is tapered before welding. This extra heavy-duty design ensures a long life both on and off road.
- In most cases control arms are longer than factory to adjust for caster. This is not always true for other brand lifts! Each arm bushing can be easily greased without removing the arm from the vehicle.
- 4-Door JK's will get on average a 4" lift. Two door models will get up to a 5" lift. All lifts are dependent on specific Jeep® characteristics and additional parts being put on the vehicle (bumpers, winch, hard tops, soft tops etc.).
- Due to the changed pinion angle, we highly recommend a new drive shaft be installed when using any 4" or greater lift kit on a 4-Door Wrangler. A new drive shaft will be required on any 2007-10 2-Door Wrangler due to the shorter wheel base.
- All 4" Kits require a drop pitman arm (sold separately, see Page 100).
- ORV kits with shocks include a pair of Neoprene Wrapped Grab Handles and an Off Road Organizer!



JK 4"/5" Lift Kit

07-10 Jeep® Wrangler JK/Rubicon, 4WD (2 & 4-Door models)	Kit w/o Shocks	Kit w/ Shocks	Max Tire Size HxWxD	Max Wheel Offset	Est. Install Time
2.5"-3.5" Lift, 07-10 Jeep® Wrangler, 2 & 4-Door	18401.50	18415.50	34"x12.5"x16"	4.5"	6 Hrs.
4"-5" Lift, 07-10 Jeep® Wrangler, 2 & 4-Door*	18401.60	18415.60	35"x12.5"x16"	4.5"	8 Hrs

Note: due to vehicle weight, the 2-Door models may receive an additional 1" lift over 4-Door models

* Will require a drop pitman arm. Sold Separately

18401.50 Kit includes: (4) coil springs, rear track bar bracket, rear bump stop bracket, rear track bar brace, hardware kit

18401.60 Kit includes: (4) coil springs, (2) lower front links, (2) lower rear links, (2) rear bump stop brackets, (2) rear bump stop spacers, front track bar bracket, rear track bar bracket, (2) front double disconnect end links, (2) rear extended sway bar end links, rear track bar brace, hardware kit

CAUTION!
CAUTION: Rugged Ridge™ recommends use of wheel spacers with all suspension lifts to reduce risk of roll over or other accident associated with modifying ride height for increased off road capabilities. See additional product safety information and WARNINGS at back of catalog.

CV Equipped Drive Shafts for 07-10 Wranglers

Reduce or eliminate driveline vibration with a CV-equipped driveshaft. Constant Velocity (CV) joints use two U-joints (double cardan style) in the place of a single U-joint. This smooths out the driveline angle and reduces vibration due to extreme lifts or driveline changes. Works with stock to 6" lift.

CV Equipped Drive Shafts	Part #
07-10 Wrangler, Front 2/4-Door	16592.22
07-10 Wrangler, Rear 2-Door	16592.21
07-10 Wrangler, Rear 4-Door	16592.20



16592.21 CV Equipped Rear Drive Shaft for 07-10 Wrangler 2-Door



What to Buy:

When looking at which kit is best for your application you need to determine two important things: size of tire and use of vehicle. On the 97-06 Wrangler TJ, 2" spacer lifts are designed for a larger tire than factory and light off road use. The 2" coil kit is designed for a larger tire and moderate off road use. The 4" coil kit is designed for more severe off road use and up to a 34" x 12.5" x 15" tire.



ORV 2" Poly Spacer for 1997-2006 Wrangler 18415.33

- Low cost kit that provides a small lift for over sized tires
- Each kit contains 4 spacers and four bump stops
- Spacers are made of durable polyurethane for a long life

ORV Coil Spring Lift Kits Feature:

- Get off road performance while not sacrificing on road ride! This kit will provide as close to factory a ride as you can get while providing off road articulation.
- Includes four powder coated, E-coated 5160H hot rolled bar, 5/8" coil springs that are set to original factory rates. By using 5160H hot rolled bar, ORV springs keep their memory eliminating any possibility of future sag.
- By setting the coil springs to factory rates, you get the best on road ride possible and the ability to use a larger tire.
- ORV uses tough, over built extended control arms for added strength and higher performance. Each arm has a beefy 3/16" wall thickness and each end is tapered before welding; this extra heavy-duty design ensures a long life, both on and off road.
- In most cases control arms are longer than factory to adjust for caster. This is not always true for other brand lifts! Each arm bushing can be easily greased without removing the arm from the vehicle.
- Each 2" Coil Spring Lift Kit includes 1" transfer case lowering brackets. These are not spacers but full-length brackets that actually solidly secure your transfer case. ORV uses these brackets rather than spacers as spacers can create flex therefore putting undue stress on the drive line.
- Each 4" Coil Spring Lift Kit includes 1.5" transfer case lowering brackets. These are not spacers but full length brackets that actually "true" your transfer case. ORV uses these brackets rather than spacers, as spacers can create flex therefore putting undue stress on the drive line.
- Kit includes two sway bar disconnects for more off road articulation.
- Due to the changed pinion angle, we highly recommend a new drive shaft and a slip yoke eliminator kit be installed when using any 4" or greater lift kit on a 1997-2006 Wrangler/Unlimited.
- All 4" Kits will require the purchase of a drop pitman arm to ensure proper steering geometry (sold separately).
- All ORV Kits with shocks include a pair of Neoprene Wrapped Grab Handles and an Off Road Organizer for your glove box!

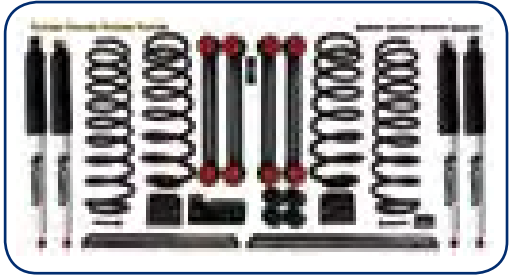

2" Lift for 2003-06 Wrangler/Rubicon 18415.32

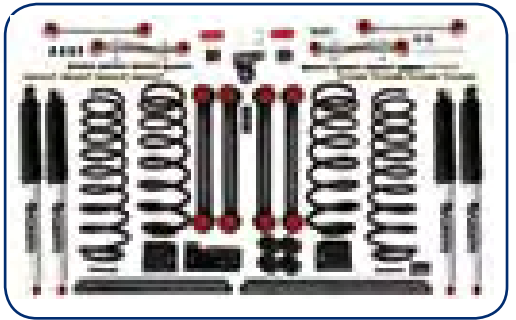

4" Lift for 2003-06 Wrangler/Rubicon 18415.42

97-06 Wrangler, 04-06 Wrangler Unlimited	Kit w/o Shocks	Kit w/ Shocks	Max Tire Size HxWxD	Max Wheel Offset	Est. Install Time
2" Poly Spacer (4) Lift, 97-06 Wrangler	18401.33	18415.33	32"x11.5"x15"	3.75"	4 Hrs.
2" Lift, 97-02 Wrangler	18401.30	18415.30	32"x11.5"x15"	3.75"	6 Hrs.
2" Lift, 03-06 Wrangler/Rubicon	18401.31	18415.31	32"x11.5"x15"	3.75"	6 Hrs.
2" Lift, 04-06 Wrangler Unlimited/Rubicon	18401.32	18415.32	32"x11.5"x15"	3.75"	6 Hrs.
4" Lift, 97-02 Wrangler*	18401.40	18415.40	34"x12.5"x15"	3.75"	6 Hrs.
4" Lift, 03-06 Wrangler/Rubicon*	18401.41	18415.41	34"x12.5"x15"	3.75"	6 Hrs.
4" Lift, 04-06 Wrangler Unlimited/Rubicon*	18401.42	18415.42	34"x12.5"x15"	3.75"	6 Hrs.

* Will require a drop pitman arm. Sold separately.

18401.30 Kit includes: (4) coil springs, (4) lower links, track bar relocation bracket, (3) transfer case lowering brackets, hardware kits

18401.40 Kit includes: (4) coil springs, (4) lower links, track bar relocation bracket, (2) transfer case lowering brackets, (2) transmission lowering brackets, hardware kits

18401.31/.32 Kit includes: (4) coil springs, (4) lower links, track bar relocation bracket, (2) transfer case lowering brackets, (2) transmission lowering brackets, hardware kits

18401.41/.42 Kit includes: (4) coil springs, (2) lower front links, (2) lower rear links, (2) rear bump stop brackets, rear track bar relocation bracket, front double disconnect link, rear sway bar end links, (2) transfer case lowering brackets, (2) transmission lowering brackets, hardware kits.

* See SYE Kits and Drive Shafts on page 85.

CV Equipped Drive Shafts for 87-06 Wranglers



16592.05

CV Equipped Drive Shafts	Part #
87-93 Wrangler with up to 3" Lift	16592.01
87-93 Wrangler with over 3" Lift	16592.02
94-95 Wrangler with up to 3" Lift **	16592.03
94-95 Wrangler with over to 3" Lift **	16592.04
97-06 Wrangler with 2"-6" Lift	16592.05
97-06 Wrangler with 3.5"-6" Lift (for Mega Short SYE only)	16592.06

Body Lifts for 1997-06 Wrangler



18303.11 Body Lift Kit, 1997-06 Wrangler

Need some extra clearance for your oversized tires? This all new Rugged Ridge body lift includes everything you need to fit up to 33" diameter tires. By allowing a taller tire you'll get that extra ground clearance you need when facing off road obstacles.

3" Body Lift	Part #
97-06 Wrangler with automatic, 97-04 5-speed or 6-speed transmission, Kit	18303.11
97-04 Wrangler with 5-speed, 97-06 Wrangler with automatic transmission, Kit	18303.10
Upgrade kit for all Wrangler with 6-speed manual transmission, Kit	18303.20
(18303.10 + 18303.20 = 18303.11)	

WARNING HIGHER FOLLOVER RISK

Rugged Ridge™ does not recommend combined use of body lifts with suspension or other lift devices or modification, alteration or fabrication of any Rugged Ridge™ product to achieve additional lift. See additional product safety information and WARNINGS on page 101.

1955-95 CJ/Wrangler

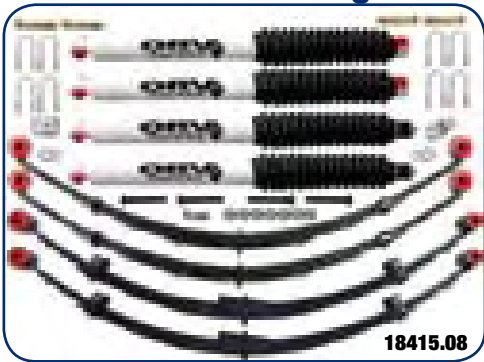

18415.08

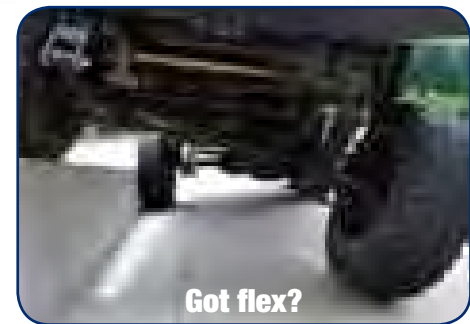

Got flex?



18401.20

What to Buy:

When looking at which kit is best for your application you need to determine two important things: size of tire and use of vehicle. On the 1976-95 CJ/Wrangler, the 2" - 2.5" Leaf Spring kits are designed for a tire size up to 31" and moderate off road use. The 1955-95 CJ/Wrangler 4" Leaf Spring kits are designed for more severe off road use and up to a 33" x 12.5" x 15" tire.

ORV™ Leaf Spring Lift for 1955-1995 CJ / Wrangler

- Get off road performance without sacrificing on road ride! These kits provide as close to a factory ride as possible.
- Includes 4 powder coated, shot-peened leaf springs with Teflon inserts and pre-installed degree wedges.
- Each leaf spring has Teflon between each leaf for a factory ride, better performance.
- Pre-installed degree wedges provide ease of installation and no more parts to buy. These wedges help to correct any pinion angle issues that may arise due to the lift.
- By shot-peening the leafs before assembly, it assures that the leaf springs will not sag over time.
- All ORV U-bolts are grade-8 and E-coated to ensure they will be able to take off road abuse.
- Due to the changed pinion angle, we highly recommend a new drive shaft and a slip yoke eliminator kit be installed when using any 4" or greater lift kit on a 87-95 Wrangler (see below).
- All 4" Kits will require the purchase of a drop pitman arm to ensure proper steering geometry (sold separately, see below).
- Note: Actual lift height is dependent on specific Jeep® characteristics and additional parts being put on the vehicle (bumpers, winch, hard tops, soft tops etc.).
- ORV kits with shocks include a pair of Neoprene Wrapped Grab Handles and an Off Road Organizer!

	Kit w/o Shocks	Kit w/ Shocks	Max Tire Size-HxWxD	Max Wheel Offset	Est. Install Time
87-95 Wrangler, 2"-2.5" Lift	18401.20	18415.20	31"x10.5"x15"	3.75"	4 Hrs.
87-95 Wrangler, 4" Lift*	18401.25	18415.25	33"x12.5"x15"	3.75"	6 Hrs.
76-86 CJ5, CJ7, CJ8, 2"-2.5" Lift	18401.08	18415.08	31"x12.5"x15"	3.75"	4 Hrs.
76-86 CJ5, CJ7, CJ8, 4" Lift*	18401.15	18415.15	33"x12.5"x15"	3.75"	4 Hrs.
55-75 CJ5, CJ6, 4" Lift*	18401.14	18415.14	33"x12.5"x15"	3.75"	4 Hrs.

* 87-95 Wrangler 4" Lift see SYE kits & CV driveshafts on page 85.

* 72-76 models will require a drop pitman arm. Sold separately. (See below)

18401.20 Kit includes: (4) leaf springs, (8) U-bolts, hardware kits.

18401.25 Kit includes: (4) leaf springs, (8) U-bolts, hardware kits, (2) track bar extension brackets.

18401.08/.15 Kit includes: (4) leaf springs, (8) U-bolts, hardware kits.

18401.14 Kit includes: (4) leaf springs, (8) U-bolts, hardware kits.

WARNING: See page 95 for important safety information.

Drop Pitman Arms

Lifting a vehicle takes more than just slapping on taller springs. The stock steering linkage is designed for use with the stock height suspension. The steering linkage angles of a lifted vehicle are more extreme and influenced by suspension travel. This drop pitman arm helps reduce the angle of your drag link and reduce bumpsteer created when a suspension lift is installed.



18006.50

Drop Pitman Arms

Part

07-10 Wrangler w/Power Steering, 3.5"-6" of Lift	18006.55
87-06 Wrangler w/Power Steering, 4" of Lift	18006.50
87-06 Wrangler w/Manual Steering, 4" of Lift	18006.52
93-98 Grand Cherokee w/Power Steering, 4"-8" of Lift	18006.54
84-01 Cherokee w/Power Steering, 4"-8" of Lift	18006.54
76-86 CJ w/Power Steering, 4" of Lift	18006.51
76-86 CJ w/Manual Steering, 4" of Lift	18006.53
72-75 CJ w/Power Steering, 4" of Lift	18006.57

WARNING: See page 95 for important safety information.

Universal Leaf Spring Perch/Weld-On

- Replacement for collapsed perches
- Allows for relocation of leaf springs or change to wider springs
- Weld-on installation



18267.01

Universal Leaf Spring Perch/Weld-On	Axle Tube Radius	Part #
Universal Spring Perch Pair	1.75" Wide	18267.01 (NEW)
Universal Spring Perch Pair	2" Wide	18267.02 (NEW)
Universal Spring Perch Pair	2.5" Wide	18267.03 (NEW)
Universal Spring Perch Pair	3" Wide	18267.04 (NEW)

Degree Wedges

Degree wedges are used to correct pinion angle and reduce driveline vibration on lifted leaf spring equipped vehicles.



Degree Wedges, 76-86 CJ, 87-95 YJ

Degree Wedges, 76-86 CJ, 87-95 YJ	Part #
Cast Aluminum Wedge Pair (for 6° pinion angle)	18206.01
Cast Aluminum Wedge Pair (for 8° pinion angle)	18206.02



1984-01 Cherokee

84-01 Jeep® Cherokee XJ 3" Lift

- Custom designed add-a-leaf springs with polyurethane bushings for a soft ride & easy installation.
- Tough powder coat finished (E-coated pre finish) U-bolts.
- Kit also includes 2 lower links and front track bar bracket.
- ORV kits with shocks include an Off Road Organizer!



84-01 Jeep® Cherokee XJ, 4WD/2WD	Kit w/o Shocks	Kit w/ Shocks	Max Tire Size-HxWxD	Max Wheel Offset	Estimated Install Time
3" Lift, 84-01 Jeep® Cherokee, 2WD/4WD**	18401.70	18415.70	31"x10.5"x15"	3.75"	6 Hours

**Add-A-Leaf Rear

18401.70 Kit includes: (2) front coil springs, (2) rear add-a-leaf springs

⚠️WARNING: WARNING: See page 95 for important safety information.

1993-98 Grand Cherokee

93-98 Jeep® Grand Cherokee 3" Coil Spring Lifts

- Custom designed coil springs for a soft ride, great on road performance.
- Kit includes standard links with urethane bushings for a great ride and long life.
- Also includes front track bar bracket.
- ORV kits with shocks include an Off Road Organizer!



93-98 Jeep® Grand Cherokee ZJ, 4WD/2WD	Kit w/o Shocks	Kit w/ Shocks	Max Tire Size-HxWxD	Max Wheel Offset	Estimated Install Time
3" Lift, 93-98 Jeep® Grand Cherokee, 2WD/4WD	18401.75	18415.75	31"x10.5"x15"	3.75"	8 Hours

18401.75 Kit includes: (4) coil springs, (4) lower links, front track bar bracket, hardware kit

⚠️WARNING: WARNING: See page 95 for important safety information.

1999-04 Grand Cherokee

99-04 Jeep® Grand Cherokee 2" Poly Spacer Lift

- Custom Spacer kit that gives you a more aggressive look while providing great on road performance.
- Kit includes 4 polyurethane spacers and all necessary installation hardware.
- ORV kits with shocks include an Off Road Organizer!
- Due to enhanced OE springs, bump stops are not required on this kit.



99-04 Jeep® Grand Cherokee WJ, 4WD/2WD	Kit w/o Shocks	Kit w/ Shocks	Max Tire Size-HxWxD	Max Wheel Offset	Estimated Install Time
2" Poly Spacer Lift, 99-04 Jeep® Grand Cherokee, 2WD/4WD	18401.80	18415.80	31"x10.5"x16"	3.75"	4 Hours

18401.80 Kit includes: (2) front coil spacers, (2) rear coil spacers

⚠️WARNING: WARNING: See page 95 for important safety information.

Heavy Duty Shackles

Heavy duty shackles for leaf spring equipped vehicles. Sold in pairs. Available with or without bushings. Wrangler shackles provide 1" of lift. Available with greasable bushings for a quiet ride and easier flexing.

18265.16 Heavy Duty Greasable Shackles, Front, 1987-1995 YJ

Heavy Duty Shackles	Without Bushings	With Black Bushings	With Red Bushings
55-75 CJ, Front Or Rear, Kit	18265.01	-	-
55-75 CJ, Greasable Front Or Rear, Kit	18265.02	18265.03	18265.04
76-86 CJ, Front, Kit	18265.05	-	-
76-86 CJ, Rear, Kit	18265.09	-	-
76-86 CJ, Greasable, Front, Kit	18265.06	18265.07	18265.08
76-86 CJ, Greasable, Rear, Kit	18265.10	18265.11	18265.12
87-95 Wrangler, Front (adds 1" lift), Kit	18265.13	-	-
87-95 Wrangler, Rear (adds 1" lift), Kit	18265.17	-	-
87-95 Wrangler, Greasable Front (adds 1" lift), Kit	18265.14	18265.15	18265.16
87-95 Wrangler, Greasable Rear (adds 1" lift), Kit	18265.18	18265.19	18265.20





1-2003



1-1002

1-501

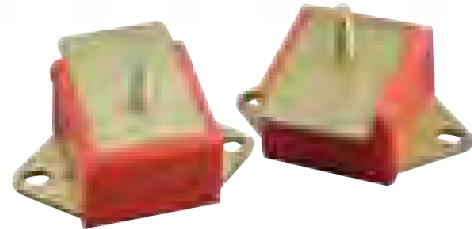

COMPLETE POLYURETHANE KIT

(includes all major suspension points for steel bodied models.
Not for fiberglass bodies):

Description	POLY #	REPLACED BY OMIX #
1955-75 CJ	1-2001	18350.01
1976-79 CJ5, CJ7	1-2002	18350.02
1980-86 CJ5, CJ7	1-2003	18350.03
1987-95 WRANGLER	1-2005	18350.05
1997-06 WRANGLER	1-2006	18350.06
1984-01 XJ CHEROKEE	1-2004	18350.04

FRONT SPRING & SHACKLE BUSHING KITS:

Description	POLY #	REPLACED BY OMIX #
1955-75 CJ	1-1001	18364.01
1976-86 CJ	1-1002	18364.02
1987-95 WRANGLER	1-1005	18364.03

REAR SPRING & SHACKLE BUSHING KITS:

Description	POLY #	REPLACED BY OMIX #
1955-75 CJ	1-1001	18364.01
1976-86 CJ	1-1003	18365.01
1987-95 WRANGLER	1-1005	18364.03
1984-01 XJ CHEROKEE	1-1007	18365.02

SHACKLE BUSHING KITS:

Description	POLY #	REPLACED BY OMIX #
1955-75 CJ, FRONT OR REAR (NEED 2)	1-805	18366.05
1976-86 CJ FRONT	1-801	18366.01
1976-86 CJ REAR	1-802	18366.02
1987-95 WRANGLER, FRONT OR REAR (NEED 2)	1-803	18366.03
1984-01 XJ CHEROKEE	1-804	18366.04

SWAYBAR BUSHING KITS:

Description	POLY #	REPLACED BY OMIX #
1976-86 CJ WITH 15/16" DIAMETER BAR, FRONT	1-1101	18367.01
1976-86 CJ WITH 7/8" DIAMETER BAR, FRONT	1-1110	18367.10
1987-95 WRANGLER WITH 1 1/8" DIAMETER BAR, FRONT	1-1107	18367.07
1987-95 WRANGLER WITH 15/16" DIAMETER BAR, FRONT	1-1102	18367.02
1997-06 WRANGLER WITH 30.5 mm DIAMETER BAR, FRONT	1-1111	18367.11
1997-06 WRANGLER WITH 13mm DIAMETER BAR, REAR	1-1112	18367.12
1984-01 XJ CHEROKEE, 1993-98 ZJ GRAND CHEROKEE 24mm, FRONT	1-1103	18367.03
1984-01 XJ CHEROKEE, 1993-98 ZJ GRAND CHEROKEE 25mm, FRONT	1-1104	18367.04
1984-01 XJ CHEROKEE, 1993-98 ZJ GRAND CHEROKEE 28mm, FRONT	1-1105	18367.05
1984-01 XJ CHEROKEE, 1993-98 ZJ GRAND CHEROKEE 23mm, FRONT	1-1106	18367.06
1984-01 XJ CHEROKEE, 1993-98 ZJ GRAND CHEROKEE 1", FRONT	1-1108	18367.08
1984-01 XJ CHEROKEE, 1993-98 ZJ GRAND CHEROKEE 7/8", FRONT	1-1115	18367.13
1984-01 XJ CHEROKEE, 1993-98 ZJ GRAND CHEROKEE 15/16", FRONT	1-1116	18367.14
1984-01 XJ CHEROKEE, 1993-98 ZJ GRAND CHEROKEE 1-1/8", FRONT	1-1117	18367.15
1984-01 XJ CHEROKEE, 5/8" BAR, REAR	1-1118	18367.16
1993-98 ZJ GRAND-CHEROKEE, REAR	1-1109	18367.09



1-1705

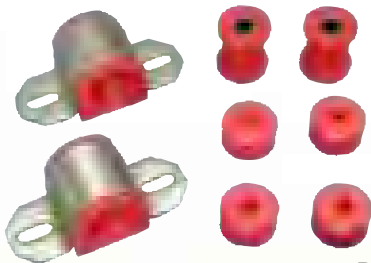

1-1104



1-1701

Polyurethane/Stainless Brake Lines

TRACK ARM BUSHING KITS:

Description	REPLACED	
	POLY #	BY OMIX #
1987-95 WRANGLER, FRONT OR REAR (NEED 2)	1-1202	18368.01
1997-06 WRANGLER, FRONT	1-1205	18368.04
1997-06 WRANGLER, REAR	1-1206	18368.05
1984-01 XJ CHEROKEE, FRONT	1-1203	18368.02
1993-98 ZJ GRAND CHEROKEE, FRONT	1-1203	18368.02
1993-98 ZJ GRAND CHEROKEE, REAR	1-1204	18368.03

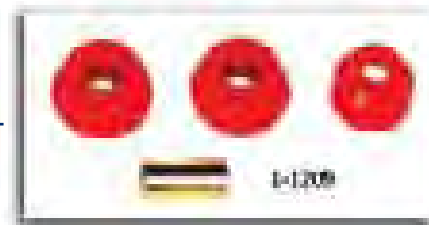

CONTROL ARM BUSHING KITS:

1997-06 WRANGLER, UPPER & LOWER, FRONT	1-204	18368.03
1984-01 XJ CHEROKEE, FRONT	1-202	18368.01
1993-98 ZJ GRAND CHEROKEE, FRONT	1-203	18368.02
1993-98 ZJ GRAND CHEROKEE, REAR	1-301	18362.04



COIL SPRING INSULATORS:

1997-03 WRANGLER, PAIR	1-1701	18369.04
------------------------	--------	----------

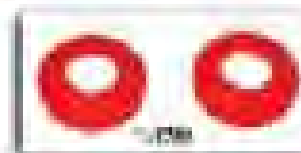

COIL SPRING INSULATOR LIFT:

2007-10 WRANGLER, PAIR, 2" LIFT (NEW)	1-1708	18369.05
---------------------------------------	--------	----------

BODY MOUNT BUSHING SETS:

1955-73 CJ (14 PCS)	1-101	18351.01
1974-75 CJ (18 PCS)	1-109	18351.07
1976-79 CJ5, CJ7 (22 PCS)	1-102	18351.02
1980-86 CJ5, CJ7 (22 PCS)	1-103	18351.03
1981-86 CJ8 (26 PCS)	1-104	18351.04
1987-95 WRANGLER (22 PCS)	1-105	18351.05
1997-06 WRANGLER (22 PCS)	1-107	18351.06

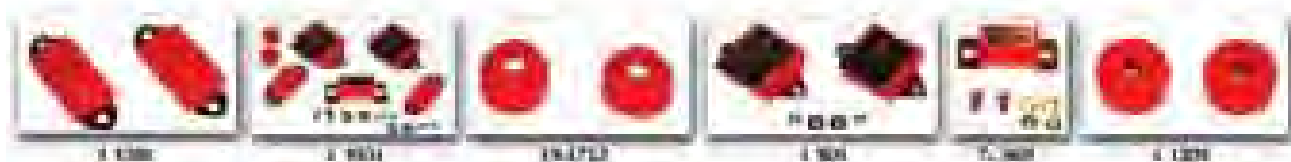

MISC. POLYURETHANE ITEMS:

Description	REPLACED	
	POLY #	BY OMIX #
1976-95 CJ & WRANGLER AXLE SNUBBER PAIR	1-1301	18369.03
1976-86 CJ 6 CYL COMPLETE DRIVE TRAIN KIT	1-1901	18390.50
1945-95 CJ & WRANGLER, TIE ROD BOOTS	19-1712	18369.02
1972-86 CJ 6 CYL ENGINE MOUNT PAIR	1-501	18390.01
1987-06 WRANGLER & XJ CHEROKEE 6-CYL ENGINE MOUNT PAIR	1-502	18390.02
1967-92 V8 AMC ENGINE MOUNT PAIR	1-503	18390.03
1973-95 CJ & WRANGLER TRANS. MOUNT	7-1604	18392.01
1997-06 WRANGLER TRANS. MOUNT	1-1601	18391.01
1973-95 CJ & WRANGLER TRANS. TORQUE ARM BUSHING PAIR	1-1201	18369.01
JACK HANDLE GRABBER (ANTI-RATTLE), ALL HI LIFT STYLE JACKS (NEW)	19-1404	18369.50

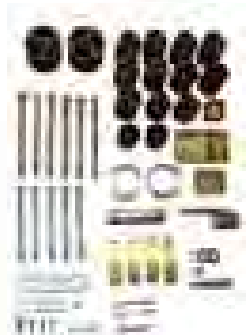

FRONT & REAR BRAIDED STAINLESS STEEL BRAKE LINES:

(PROVIDES UP TO 4" EXTRA LENGTH. ESSENTIAL FOR LIFTED VEHICLES)

Description	Part #	Description	Part #
1955-71 CJ W/ DRUM BRAKES FRONT PAIR	16734.01	1955-66 CJ REAR SINGLE	16735.01
1972-73 CJ W/ DRUM BRAKES FRONT PAIR	16734.02	1967-73 CJ SINGLE, REAR	16735.02
1974-75 CJ W/ DRUM BRAKES FRONT PAIR	16734.03	1974-75 CJ SINGLE, REAR	16735.03
1976-78 CJ W/ DRUM BRAKES FRONT PAIR	16734.04	1976-86 CJ SINGLE, REAR	16735.04
1976-81 CJ W/ DISC BRAKES FRONT PAIR	16734.05	1987-95 WRANGLER REAR SINGLE	16735.05
1982-86 CJ W/ DISC BRAKES FRONT PAIR	16734.06	1997-06 WRANGLER REAR SINGLE	16735.06
1987-95 WRANGLER FRONT PAIR	16734.07	1992-01 CHEROKEE 4WD (3-PIECE FRONT & REAR)	16735.09
1997-06 WRANGLER FRONT PAIR	16734.08	1993-98 GRAND CHEROKEE W/ REAR DRUM (3 LINE)	16735.10
		1993-98 GRAND CHEROKEE W/ REAR DISC (5 LINE)	16735.11



ORV™ SUSPENSION SYSTEMS BY RUGGED RIDGE™ LIMITED LIFETIME WARRANTY

Your Omix-Ada®/Rugged Ridge™ product is covered by the Lifetime Limited Warranty explained below that gives you specific legal rights. This limited warranty is the only warranty Omix-Ada®/Rugged Ridge™/ORV™ makes in connection with your product purchase. Parts sold by Omix-Ada® or Rugged Ridge™ but supplied by other vendors are exclusively warranted by the vendor supplying the part. Omix-Ada® neither assumes nor authorizes any vendor, retailer or other person or entity to assume for it any other obligation or liability in connection with this product or Limited Warranty.

What is covered? Subject to the terms, exclusions and limitations herein and with respect only to products first sold in the United States, Omix-Ada® warrants to the initial retail purchaser only that its Rugged Ridge™ suspension kits, and ORV™ shocks and stabilizers shall be free of defects in material and workmanship for so long as the initial retail purchaser owns the vehicle on which these products were originally installed. All other express or implied warranties are hereby disclaimed. Your warrantor for these parts is Omix-Ada®, Inc., 460 Horizon Dr., Suite 400 Suwanee, GA 30024. Omix-Ada® reserves the rights to: (a.) require proof of purchase as a condition of this Limited Warranty, (b.) make future revisions to its Limited Warranty without prior notice.

What is not covered? Your Omix-Ada®/Rugged Ridge™/ORV™ Limited Warranty does not cover any Rugged Ridge™/ORV™ suspension systems that are used or combined with non-ORV™ suspension components. Furthermore, ORV™ suspensions not installed with ORV™ or other recommended shock absorbers may void the Limited Warranty. Products that wear out or fail due to the use of larger tires or wheels are not covered by this Limited Warranty. Your Omix-Ada® Limited Warranty further does not cover products or parts supplied to Omix-Ada® by outside vendors or products, parts or vehicles Omix-Ada® determines to have been damaged by or subjected to:

- Installation damage, alteration, modification or failure to maintain.
- Normal wear and tear (bushings, tie-rod ends, etc.). Scratches or defects in product finishes (powder coating, plating, etc.) or damage due to shipping.
- Damage arising or related to non-Omix-Ada®/Rugged Ridge™/ORV™, including but not limited to any vehicle's electronic stability system, related components or other vehicle systems.
- Racing or other vehicle competitions or contests. Accidents, impact by rocks, trees, obstacles or other aspects of the environment.
- Theft, vandalism or other intentional damage.
- Products used in application other than those recommended in the current/Rugged Ridge™/ORV™ catalog or the instructions accompanying your Rugged Ridge™/ORV™ product.

Remedy Limited to Repair / Replacement. The exclusive remedy provided hereunder shall, upon Omix-Ada® inspection and at Omix-Ada®'s option, be either repair or replacement of product or parts covered under this Limited Warranty. Customers requesting warranty consideration on Omix-Ada® branded parts (including Rugged Ridge™ and ORV™) should first contact the independent distributor from whom you purchased your part to obtain a Returned Goods Authorization number. All removal, shipping and installation costs are customer's responsibility. Customers requesting warranty consideration on non-Omix-Ada® branded parts should refer to the manufacturers' Limited Warranty and contact them directly. If a replacement part is needed before the Omix-Ada® part can be returned, you must first purchase the replacement part. Then, if Omix-Ada® deems the part warrantable, you will be credited the purchase price.

Other Limitations - Exclusion of Damages - Your Rights Under State Law

- In consideration of the purchase price paid, neither Omix-Ada® nor any independent Omix-Ada® distributor/licensee are responsible for any time loss, rental costs, or for any incidental, consequential, punitive or other damages you may have or incur in connection with any part or product purchased. Your exclusive remedy hereunder for covered parts is repair/ replacement as described above.

- This Limited Warranty gives you specific rights. You may also have other rights that vary from state to state. For example, while all implied warranties are disclaimed herein, any implied warranty required by law is limited to the terms of Limited Warranty described above. Some states do not allow limitations of how long an implied warranty lasts and /or do not allow the exclusion or limitation of incidental or consequential damages, so the limitations and exclusions herein may not apply to you.



©Omix-Ada®, Inc. 9.1.2010.
All Rights Reserved.

Only Outland™ Side Tube Steps can offer you both 3" and 4" round Tube Steps for your truck

Whether you own a "beef up" lifted truck or a stock design, Outland Automotive makes a tube step for you! Our complete line of high quality 3" Tube Steps are the perfect solution for any truck or SUV looking for a sturdy step and great looks. Our 4" steps offer Crew Cab owners a little "extra beef" when they want that heavy duty and extra step space! All Outland Tube Step designs feature the highest quality finish, easy to install brackets and a complete application listing for today's (and yesterdays!) most popular trucks and SUV's: These are not your typical Tube Steps!

The Outland™ Quality Advantage:

- Outland Stainless Tube Steps feature prime 304L, .05" wall stainless tubing polished to a mirror finish. The polishing process for an Outland step is longer and deeper pulling out the deepest shine from the steel. A true "deep polish"! Since Outland uses 304L stainless, these side steps will never rust, providing years of use and great Looks.
- Outland painted steel Tube Steps feature special E-coated, .07" wall steel that is "thick source" powder coat painted for a tough chip resistant finish. The special E-coat under coating provides double rust protection as it bonds to the metal creating a protective layer found no where else.
- All Outland Tube steps feature no drill installation (except 76-06 Jeep models) for ease of installation and a truly custom fit. All Tube Step Installation brackets are constructed of durable 3/8"-1/4" powder coat painted steel for long life and years of bounce free use.
- Each Tube Step feature special UV treated no-slip step pads with 5 mounting pins. These step pads are installed on a compressed portion of the tube - no exposed metal to rust.



3" Round Black Tube Step

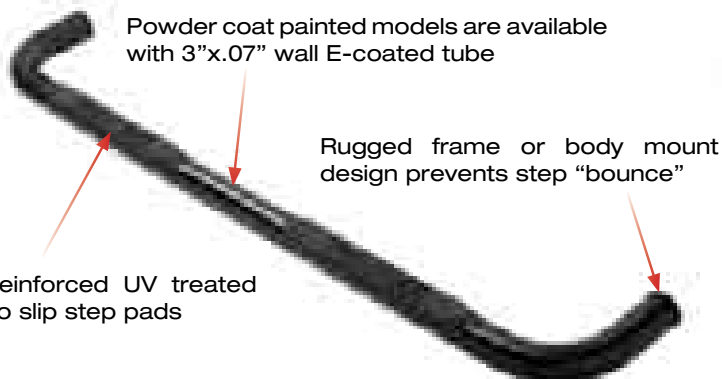

3" Round Stainless Steel Tube Step

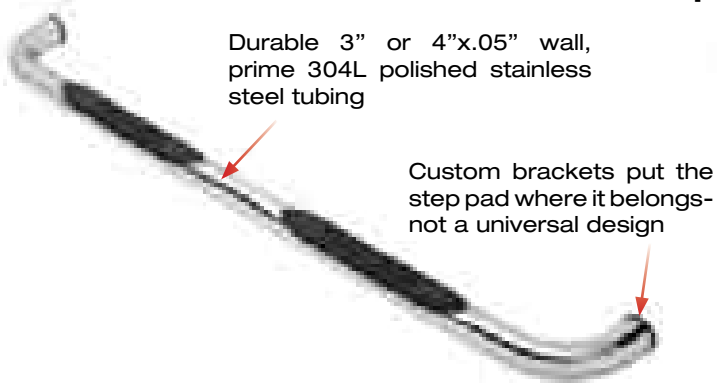

4" Round Stainless Steel Tube Step

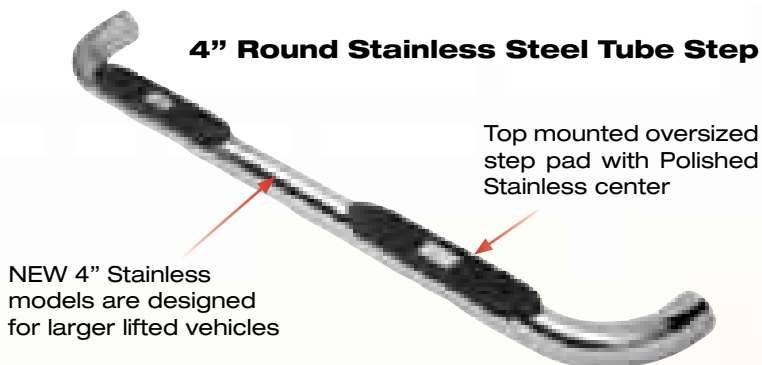

4" Round Stainless Tube Step Shown On 2007 GMC Sierra



3" Round Stainless Tube Step Shown On 2007 GMC Sierra

3" Stainless Steel/Painted Tubes Steps

Year/Model Chevy/GMC	Stainless	Black	Black Textured	Titanium
88-98 C/K Regular Cab (including Z71)	81593.02	81590.02	-	-
92-94 Blazer Full Size - 2-Door (exc ZR2)	81593.02	81590.02	-	-
92-99 Suburban	81593.01	81590.01	-	-
95-99 Tahoe/Yukon-2-Door	81593.02	81590.02	-	-
00-10 Tahoe/Yukon-4-Door (exc 04-07 Z71)	81593.03	81590.03	-	-
00-10 Suburban/Yukon XL Avalanche 1500	81593.04	81590.04	-	-
99-10 Silverado/Sierra Crew Cab Inc. HD	81593.05	81590.05	-	-
99-10 Silverado/Sierra Ext Cab Inc. HD	81593.06	81590.06	-	-
88-98 C/K Ext Cab	81593.07	81590.07	-	-
04-10 Colorado/Canyon Ext Cab	81593.08	81590.08	-	-
04-10 Colorado/Canyon Crew Cab	81593.09	81590.09	-	-
07-10 Silverado/Sierra Ext Cab	81593.10	81590.10	-	-
07-10 Silverado/Sierra Crew Cab	81593.11	81590.11	-	-
Dodge				
04-10 Durango	81593.12	81590.12	-	-
94-01 Ram-Quad Cab	81593.13	81590.13	-	-
02-08 Ram-Quad Cab	81593.14	81590.14	-	-
06-08 Ram Mega Cab	81593.15	81590.15	-	-
Ford				
99-10 Super Duty Super Cab	81593.16	81590.16	-	-
99-10 Super Duty Crew Cab	81593.17	81590.17	-	-
99-03 F150 Ext Cab	81593.18	81590.18	-	-
01-03 F150 Super Crew	81593.19	81590.19	-	-
04-08 F150 Super Cab	81593.20	81590.20	-	-
04-08 F150 Super Crew	81593.21	81590.21	-	-
98-06 Expedition	81593.22	81590.22	-	-
Jeep				
07-10 Wrangler (JK)-4-Door	81593.06	81590.06	11591.06	-
07-10 Wrangler (JK)-2-Door	81593.05	81590.05	11591.05	-
97-06 Wrangler	81593.04	81590.04	11591.04	11592.04
87-95 Wrangler	11593.03	11590.03	11591.03	11592.03
76-86 CJ 7	11591.02	11590.02	11592.02	-
76-83 CJ 5	-	11590.01	-	-
84-01 Cherokee 4-Door (Will fit 2-Door)	11590.81	-	-	-
99-04 Grand Cherokee	81593.32	-	-	-
05-10 Grand Cherokee	81593.33	-	-	-
Nissan				
04-10 Titan Ext Cab	81593.23	81590.23	-	-
04-10 Titan Crew Cab	81593.24	81590.24	-	-
Toyota				
00-06 Tundra Ext Cab	81593.25	81590.25	-	-
04-06 Tundra Double Cab	81593.26	81590.26	-	-
05-10 Tacoma Double Cab	81593.27	81590.27	-	-
05-10 Tacoma Ext Cab	81593.28	81590.28	-	-
07-10 Tundra Ext Cab	81593.29	81590.29	-	-
07-10 Tundra Crew Max	81593.30	81590.30	-	-
06-10 FJ Cruiser	81593.31	81590.31	-	-

Note: 76-06 Jeep CJ/Wrangler models require frame mounting. Drilling required.



4" Stainless Steel

Year/Model Chevy/GMC	Part #
99-06 Silverado Ext Cab 1500/2500/3500 Inc. HD	81520.01
99-06 Sierra Ext Cab 1500/2500/3500 Inc. HD	81520.01
01-06 Silverado Crew Cab	81520.02
01-06 Sierra Crew Cab	81520.02
07-10 Silverado Ext Cab 1500/2500/3500	81520.03
07-10 Sierra Ext Cab 1500/2500/3500	81520.03
07-10 Silverado Crew Cab	81520.04
07-08 Sierra Crew Cab	81520.04
06-08 Hummer H3	81520.25
Dodge	
06-08 Ram Mega Cab	81520.30
02-08 Ram Quad Cab 1500/2500/3500	81520.31
Ford	
04-08 F150 Super Cab XLT 4-Door	81520.50
04-08 F150 Super Crew	81520.51
99-10 Super Duty Super Cab	81520.52
99-10 Super Duty Crew Cab	81520.53
Nissan	
04-10 Tundra Double Cab	81520.80
Toyota	
07-10 Tundra Double Cab	81520.90
07-10 Tundra Crew Max	81520.91
Jeep	
07-10 Wrangler 4-Door	11593.08
07-10 Wrangler 2-Door	11593.07



**3" Round Black Tube Step
Shown On Dodge Ram**



**4" Round Stainless Tube Step
Shown On Dodge Ram**

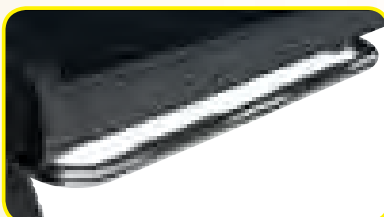

**3" Round Stainless Tube Step
Shown On Ford 150**



**4" Round Stainless Tube Step
Shown On Ford 150**

Truck/SUV Bull Bars

The Outland™ Quality Advantage:

- Outland Stainless Bull Bars feature prime 304L, .05" wall stainless tubing polished to a mirror finish. The polishing process for an Outland Bull Bar is the same used on their high quality tube steps pulling the true shine out of the metal. By using only prime 304L stainless, these stainless Bull Bars will never rust, providing years of use and great looks.
- Outland painted steel 3" Bull Bars feature special E-coated, .07" wall steel that is "thick source" powder coat painted for a tough chip resistant finish. The special E-coat under coating provides double rust protection as it bonds to the metal creating a protective layer found no where else.
- All Outland Bull Bars have ground smooth welds that provide a "seamless" look on the vehicle giving you the best looking Bull Bar on the market! By grinding these welds smooth on the Black powder coat painted models, you virtually eliminate any rust points. Great looks, long life, that is what Outland is all about.
- Outland Bull Bars feature no hassle installation. Each Bull Bar is custom fit for the specific vehicle making sure the mount points are the strongest available. Tough 3/8"-1/4" powder coat painted mounting brackets and oversized hardware ensure that the Bull Bar provides years of vibration free use.
- Each Bull Bar includes a matching skid plate for added protection and dynamic good looks. Each skid plate is laser cut to ensure clean smooth lines and a no hassle installation.

Complete the look of your Truck or SUV with an Outland Bull Bar! The "overbuilt" grille guards provide front end protection from brush and small trees while giving your vehicle a true off road look. Only Outland gives you two Bull Bar size options: 4" for those oversized trucks and 3" designs in both polished stainless steel and durable black powder coat finishes. All Outland Bull Bars feature a one piece design with ground smooth welds and a durable skid plate for added protection. When you need the best, look to Outland!



3" Stainless Bull Bar Shown on 2007 Sierra



4" Stainless Bull Bar Shown on 2007 Sierra



3" Black Bull Bar Shown on Dodge Ram



4" Stainless Bull Bar Shown on Dodge Ram



3" Stainless Bull Bar Shown on Ford F150



4" Stainless Bull Bar Shown on Ford F150

3" Stainless Bull Bar

Durable 3" or 4"x.05" wall, prime 304L polished stainless steel tubing

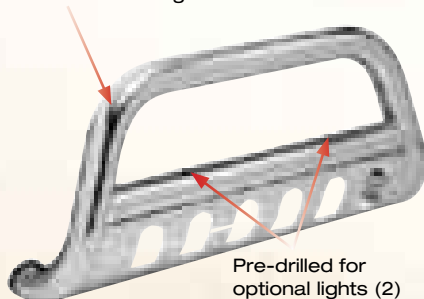

Pre-drilled for optional lights (2)

3" Black Bull Bar

Powder coat painted models are available with 3"x.07" wall E-coated tubing

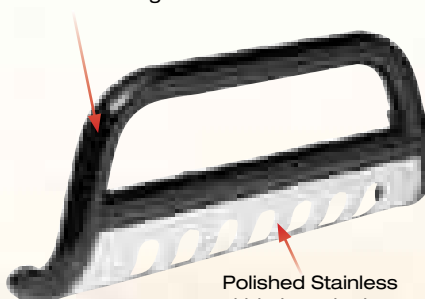

Polished Stainless skid plates look great, prevent rust

4" Stainless Bull Bar

NEW 4" Stainless Bull Bars are designed for larger, lifted vehicles

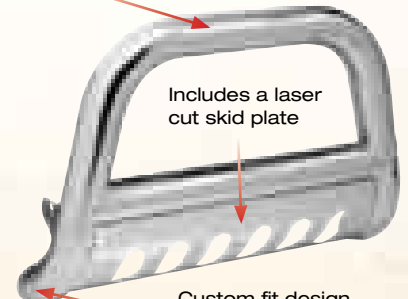

Includes a laser cut skid plate

Custom fit design provides a great look specific to your vehicle



**3" Stainless Bull Bar/Tube Steps
Shown On 2007 GMC Sierra**



**3" Black Bull Bar/Tube Steps
Shown On Dodge Ram**



**3" Stainless Bull Bar/Tube Steps
Shown On Ford F150**



**4" Stainless Bull Bar/Tube Steps
Shown On 2007 GMC Sierra**



**4" Stainless Bull Bar/Tube Steps
Shown On Dodge Ram**



**4" Stainless Bull Bar/Tube Steps
Shown On Ford F150**

4" Stainless Bull Bar

Year/Model Chevy/GMC	Part #
02-06 Avalanche 1500	81501.01
01-06 Silverado 1500 LD	81501.01
00-06 Suburban 1500	81501.01
00-06 Tahoe 1500	81501.01
01-06 Sierra 1500 LD	81501.01
00-06 Yukon/Yukon XL 1500 Exl. Denali	81501.01
07-10 Silverado 1500HD	81501.02
07-10 Silverado 2500LD	81501.02
07-10 Silverado 2500HD	81501.02
07-10 Silverado 3500HD	81501.02
07-10 Sierra 1500/2500/3500HD	81501.02
07-10 Sierra 2500LD	81501.02
06-08 Hummer H3	81501.25
Dodge	
02-08 Ram 2500/3500	81501.30
02-05 Ram 1500 (Exl. Daytona, Rumble Bee/SRT-10)	81501.30
06-08 Ram Mega Cab	81501.30
Ford	
99-06 Super Duty 250/350	81501.50
04-09 F150	81501.51
07-10 Super Duty 250/350	81501.52

3" Bull Bars

Year/Model Black Chevy/GMC	Stainless	Black
07-10 Avalanche 1500, Tahoe - 1/2 ton (1500), Suburban 1500, GMC Yukon/Yukon XL - 1/2 ton (1500), GMC Yukon/Yukon XL	82501.01	82001.01
01-06 Avalanche 1500 (with or without cladding), 00-06 Suburban - 1/2 ton (1500), 99-06 Silverado 1500LD, 00-06 Tahoe - 1/2 ton (1500), 99-06 GMC Sierra 1500, 00-06 GMC Yukon/Yukon XL - 1/2 ton (1500)	82501.02	82001.02
01-06 Avalanche 2500 (with or without cladding), 99-06 Silverado 2500LD, 01-06 Silverado1500HD/2500HD/3500HD, 00-06 Suburban - 3/4 ton (2500), 00-06 Tahoe - 3/4 ton (2500) 99-06 GMC Sierra 2500 LD, 01-06 GMC Sierra 1500HD/2500/3500HD, 00-06 GMC Yukon/Yukon XL - 3/4 ton (2500)	82501.03	82001.03
07-10 Avalanche 2500, Suburban/Tahoe/Yukon/Yukon XL 3/4 Ton (2500)	82501.04	82001.04
92-94 Full Size Blazer/Jimmy, 88-98 Chevy/GMC C/K Series 1500 PU, 88-98 Chevy/GMC C/K Series 2500/3500 PU, 92-99 Suburban/Tahoe/Yukon	82501.05	82001.05
04-08 Colorado, 04-09 GMC Canyon	82501.06	82001.06
07-10 Silverado/Sierra 1500LD	82501.07	82001.07
07-10 Silverado/Sierra 1500HD/2500/3500HD	82501.08	82001.08
Dodge		
94-01 Ram 1500 (Excludes 99-01 Sport models), 94-02 Ram 2500/3500(Excludes 99-02 Sport models)	82501.09	82001.09
02-05 Ram 1500 (Excludes Daytona/Rumble Bee/SRT-10 models), 03-08 Ram 2500/3500, 06-07 Ram Mega Cab 1500/2500/3500	82501.10	82001.10
06-08 Ram 1500	82501.11	82001.11
Ford		
00-06 Excursion, 99-04 F250/350/450/550 Super Duty	82501.12	82001.12
97-02 Expedition 4WD - (99-02 - 2WD), 97-04 F250LD, 4WD - (99-04 - 2WD), 99-04 F150/250LD 2WD, 01-03 F150 Super Crew, 04-07 Heritage	82501.13	82001.13
04-06 F150 Reg/Ext Cab & Super crew (Excludes Heritage Edition)	82501.14	82001.14
05-07 F250/350/450/550 HD Super Duty	82501.15	82001.15
08-09 F250/350/450/550 HD Super Duty	82501.16	82001.16
Jeep		
07-10 Wrangler	82501.27	82001.27
06-09 Commander	82501.17	82001.17
05-07 Grand Cherokee	82501.25	
08-09 Grand Cherokee	82501.26	
Nissan		
04-09 Titan King Cab/Crew Cab, Armada	82501.18	82001.18
05-07 Frontier PU, Pathfinder, X-Terra	82501.19	82001.19
Toyota		
03-07 4-Runner	82501.20	82001.20
07-10 FJ Cruiser	82501.21	82001.21
99-06 Tundra, 01-07 Sequoia	82501.22	82001.22
05-09 Tacoma	82501.23	82001.23
07-10 Tundra	82501.24	82001.24
License Plate Bracket (NEW)	-	81503.90



81503.90

Contractors Console

- Keeps valuables out of sight while providing a comfortable arm rest and drink holder.
- Arm rest folds forward exposing an oversized 8.5"x11" writing area.
- Reinforced hinge and lid support hold writing surface steady while writing.
- Huge storage compartment is perfect for tools paperwork, cell phones, CD's and cassettes - Keeps your vehicle clean and organized.
- Oversized dual adjustable cup holders secure different size cups and bottles.
- Special bottom mount strap allows for center seat belt mounting.
- New removable organizer tray, keeps small items in their place.
- Dimensions - 18.5" Length x 10.5" Width x 8" Height

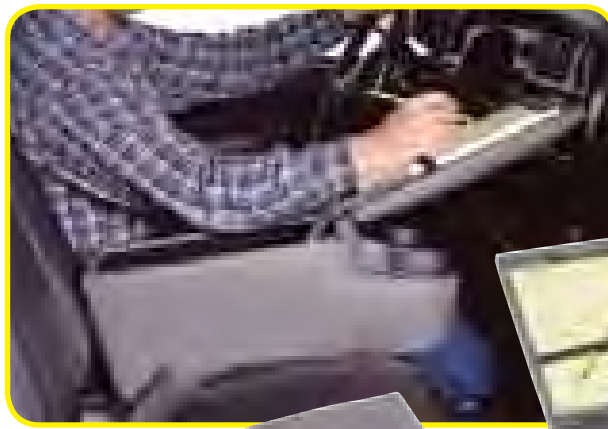

Contractors Console	Charcoal	Tan	Blue
Rugged Ridge Part #	33102.09	33102.04	33102.05



Truck Bench Seat Console

- Large rear storage area has a built-in CD cassette holder.
- Front storage area holds cell phones, glasses, tissues, coins and other small items.
- Can be used for rear seat use to organize clutter and provide hand drink cup holders for passengers.
- Dense foam padded arm rest gives greater comfort and longer life.
- Dimensions - 16.5" Length x 8.5" Width x 9" Height

Contractors Console	Charcoal	Tan	Blue
Rugged Ridge Part #	33101.09	33101.04	33101.05



Use in the back seat of SUV's and cars to eliminate clutter



Large dual storage area holds CD's, cassettes, and cell phones



Bottom mount strap allows for center seat belt mounting

Mini Van Console

Contractors Console	Charcoal	Tan	Blue
Rugged Ridge Part #	33101.09	33101.04	33101.05

- Removable soft sided CD holder keeps CD's clean and organized.
- Front storage compartment holds sunglasses, cell phones, coins, and other small items.
- Cavernous rear storage compartment holds tissue, trash, drinks, and other larger items.
- Dual adjustable front & rear cup holders hold most cups and bottles.
- Constructed of heavy duty padded vinyl to match your interior and provide long life.
- Dense foam arm rest gives greater comfort and is better looking.
- Dimensions - 29" Length x 9" Width x 14" Height.

Large front storage area opens to a removable CD Holder

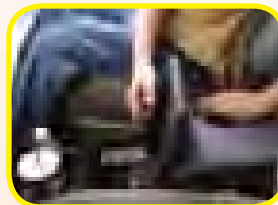

Keeps valuables out of sight and organizes your vehicle



Dual adjustable rear cup holder for back seat

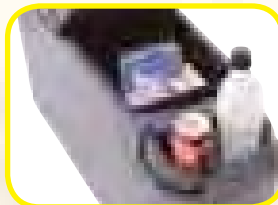

All Outland consoles feature dual adjustable cup holders that adjust to almost any cup size!



All Terrain Floor Liners

This is not your typical floor liner! Ordinary floor liners in the market today are constructed of extruded plastic materials vacuum formed to fit the vehicle. Rugged Ridge has taken a completely different approach to floor protection. Each All Terrain Floor Liner is injection molded for superior fit and quality. The injection molded process, though more expensive to develop, allows us to create a floor liner that has exacting measurements for better fit and finish along with a deeply formed perimeter wall for maximum coverage. Each All Terrain Floor Liner has chevrons that are up to 3/8" deep. That is up to 3 times the depth of other floor liners! We call this true "Deep Tread Technology"!

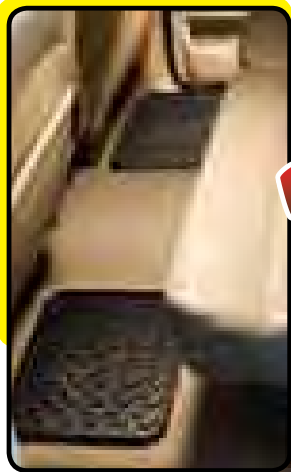

NEW!

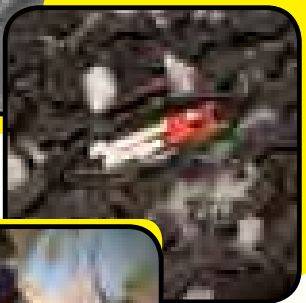

Year	Make/Model Chevy/GMC/Cadillac	Front	Rear	Kit
02-06	Avalanche (NEW)	82901.02	82950.01	82987.02
07-10	Avalanche (NEW)	82901.01	82950.01	82987.01
02-06	Escalade (NEW)	82901.02	82950.01	82987.02
07-10	Escalade (NEW)	82901.01	82950.01	82987.01
99-06	Silverado/Sierra 1500 Crew Cab (NEW)	82901.02	82950.01	82987.02
07-10	Silverado/Sierra 1500 Crew Cab (NEW)	82901.01	82950.01	82987.01
99-06	Silverado/Sierra 1500 Ext Cab (NEW)	82901.02	82950.01	82987.02
07-10	Silverado/Sierra 1500 Ext Cab (NEW)	82901.01	82950.01	82987.01
01-06	Silverado/Sierra 2500/3500 Crew Cab (NEW)	82901.02	82950.01	82987.02
07-10	Silverado/Sierra 2500/3500 Crew Cab (NEW)	82901.01	82950.01	82987.01
01-04	Silverado/Sierra 2500/3500 Ext Cab (NEW)	82901.02	82950.01	82987.02
00-06	Suburban (NEW)	82901.02	82950.01	82987.02
07-10	Suburban (NEW)	82901.01	82950.01	82987.01
00-06	Tahoe (NEW)	82901.02	82950.01	82987.02
07-10	Tahoe (NEW)	82901.01	82950.01	82987.01
00-06	Yukon (NEW)	82901.02	82950.01	82987.02
07-10	Yukon (NEW)	82901.01	82950.01	82987.01
Ford/Lincoln				
97-02	Expedition (NEW)	82902.05	82950.01	82987.25
97-03	F150 Ext Cab (NEW)	82902.04	82950.01	82987.24
04-08	F150 Ext Cab (NEW)	82902.01	82950.01	82987.21
09-10	F150 Ext Cab (NEW)	82902.03	82950.01	82987.23
97-03	F150 Reg Cab (NEW)	82902.04	82950.01	82987.24
04-08	F150 Reg Cab (NEW)	82902.01	82950.01	82987.21
09-10	F150 Reg Cab (NEW)	82902.03	82950.01	82987.23
01-03	F150 Super Crew (NEW)	82902.05	82950.01	82987.25
04-08	F150 Super Crew (NEW)	82902.01	82950.01	82987.21
09-10	F150 Super Crew (NEW)	82902.03	82950.01	82987.23
99-07	F250/F350 Super Duty (NEW)	82902.07	82950.01	82987.27
08-10	F250/F350 Super Duty (NEW)	82902.06	82950.01	82987.26
99-02	Lincoln Navigator (NEW)	82902.05	82950.01	82987.25
02-03	Lincoln Blackwood (NEW)	82902.05	82950.01	82987.25
06-08	Lincoln Mark LT (NEW)	82902.01	82950.01	82987.21
Dodge				
02-08	Ram 1500 Quad Cab (NEW)	82903.01	82950.01	82987.41
09-10	Ram 1500 Quad Cab (NEW)	82903.01	82950.01	82987.41
02-08	Ram 1500 Reg Cab (NEW)	82903.01	82950.01	82987.41
09-10	Ram 1500 Reg Cab (NEW)	82903.01	82950.01	82987.41
03-10	Ram 2500/3500 Quad Cab (NEW)	82903.01	82950.01	82987.41
06-10	Ram Mega Cab (NEW)	82903.01	82950.01	82987.41



⚠ WARNING: Always secure your load with storage retention devices (not included). Never overload your receiver rack past the limits of 200lbs of evenly spaced cargo.



Receiver Rack

- Carry those extra items with ease on the back of your vehicle.
- Mounts to any vehicle with a 2" receiver hitch
- Carries up to 200lbs of evenly distributed cargo.
- Powder coat painted for long life.
- 20"x60" platform.
- Receiver hitch pin not included.

Receiver Rack	Part #
All 2" Receiver Hitches	7700

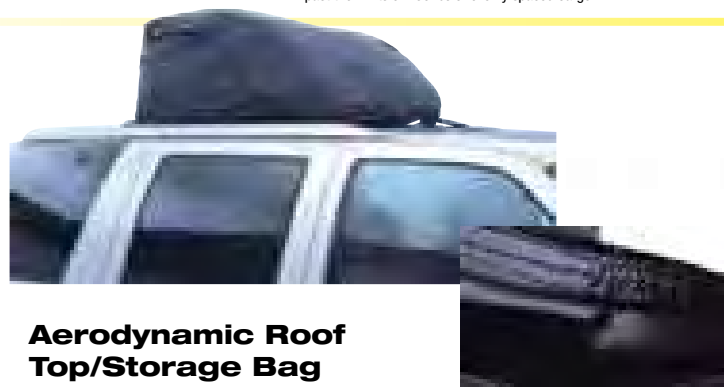

Aerodynamic Roof Top/Storage Bag

This storage system is designed for complete weatherproof protection of your cargo. The sloped front deflects water and air up and over the bag. Constructed of durable fiberglass reinforced waterproof tarpaulin material that ensures durability and weather resistance. With over 11 cubic feet of extra storage space this is a perfect alternative for expensive plastic pods. No-drilling required - attaches with heavy duty polypropylene straps to your existing roof rack.

Aerodynamic Roof Top Storage Bag	Part #
	12111.01



Auto Backpack Roof Top Storage System

This system comes in two different models, depending on your cargo requirements. The outer material is a combination of soft neoprene material to protect your paint and durable nylon for long life. Each Auto Backpack features four tie down points to make installation easy and secure. Designed to provide quick alternative storage, these easy to use and store roof top storage bags are a must for those road trips. With 13 cubic feet of storage space, this is a perfect alternative to those expensive and hard to store plastic pods.

Roof Top Storage System	Part #
(39"x32"x18"), 13 CuFt.	12110.01
(54"x48"x20") 20 CuFt	12110.02



Tailgate Nets

- Sport styling improves trucks appearance.
- Improves gas mileage by reducing tail gate drag.
- Great visibility for added safety.
- Constructed of durable die-cut polyester laminate, resists fading and stretching.
- Easy to install - some drilling required.

Contractors Console	Charcoal	Tan	Blue
Rugged Ridge Part #	33101.09	33101.04	33101.05



Universal Chrome Truck Step

- Constructed of highly polished chromed steel.
- Contoured to complement today's truck exteriors.
- One size fits most trucks/SUV's.
- Non-skid tape supplied for added safety.
- Easy to install - some drilling required.
- Sold individually.

Universal Truck Step	Part #
Universal Truck Step Chrome	31501.01

Manual Locking Hubs

Knee deep in mud with a failed automatic hub and a disabled vehicle? The only way to repair it is to replace it. The question is, with what? Factory automatic hubs have a history of failing when you need them most. A damaged hub will render your 4x4 useless and leave you stranded. Wish you could swap your venerable automatic hubs to a set of manual locking hubs? Rugged Ridge has heard your plea. Rugged Ridge Manual Locking Hubs are unanimously recognized as the world's toughest hubs by our thousands of satisfied customers worldwide. Brute strength matters, that is why the bodies of our hubs are crafted from impact resistant nodular iron, and feature a corrosion resistant die cast aluminum cap. Our hubs deliver better 4WD performance when locked and improved fuel economy in 2WD when unlocked, than automatic hubs. Purchasing a set of premium manual hubs is more cost effective than servicing your worn factory hubs. With the money you save you'll be able to carry a spare set, not that you'll need them. Sure you have to get out of the cab to lock the hubs, but unlike automatic hubs you won't have to wait until you lose traction for your four-wheel drive to engage.

Rugged Ridge Premium Hubs Feature:

- A full metal cap and body crafted from impact resistant nodular iron.
- Corrosion resistant die cast aluminum caps coated with high luster epoxy enamel for along lasting finish.
- Better 4WD performance when the manual hubs are locked. Works in reverse and compression braking.
- No slippage or partial engagement / disengagement issues that plague automatic hubs.
- Better fuel economy by freewheeling in 2WD mode. Great for any "tow vehicle".
- Decreases wear on internal components by engaging 4WD only when needed.
- More durable and cost effective than replacing or servicing automatic hubs.
- Ridiculously simple installation. Your average installation is completed in less than 20 minutes.
- Manual hubs offer extra gear ranges. By unlocking your hubs and driving in 4WD mode, you gain use of 2WD Low and 2WD High ranges.
- 1998-00 Ford Ranger (15001.70) application is exclusively available from Rugged Ridge!



Make/ Model	Years	Part #	Spline Count	Bolt Count	Make/ Model	Years	Part #	Spline Count	Bolt Count
Chevrolet / GMC					Jeep®				
Blazer, Jimmy, Suburban	69-91**	15001.18 *	19	Internal Mt.	Willys CJ2A	46-49	15001.01	10	6
1/2 Ton Pickup Truck	69-87	15001.18 *	19	Internal Mt.	Willys CJ3A	48-53	15001.01	10	6
3/4 Ton Pickup Truck (NEW)	60-76	15001.17	19	6	Willys CJ3B	53-64	15001.01	10	6
3/4 Ton Pickup Truck	77-87	15001.18 *	19	Internal Mt.	Willys M38A1	52-68	15001.01	10	6
1 Ton Pickup Truck (NEW)	76-91**	15001.39	30	Internal Mt.	CJ5 & CJ6	55-71	15001.01	10	6
Geo Tracker (NEW)	89-98	15001.38	26	6	CJ5, CJ6, CJ7	72-80	15001.02	27	6
Grand Vitara (NEW)	99-04	15001.38	26	6	CJ7 & CJ8	81-86	15001.26	27	5
Dodge / Chrysler					Jeepster Commando C101				
1/2 Ton Pickup Truck (NEW)	47-68	15001.17	19	6	Jeepster Commando C104	66-71	15001.01	10	6
1/2 Ton Pickup Truck & Ramcharger	69-75	15001.18 *	19	Internal Mt.	Wagoneer & Gladiator	72-73	15001.02	27	6
3/4 Ton Pickup Truck (NEW)	57-75	15001.17	19	6	Wagoneer & Cherokee (SJ) (NEW)	63-73	15001.01	10	6
Power Wagon WC-50 & WC-60 (NEW)	42-56	15001.08	16	6	J-10 Pickup (NEW)	74-91	15001.18 *	19	Internal Mt.
1/2 Ton Pickup Truck & Ramcharger	80-93	15001.18 *	19	Internal Mt.	J-20 Pickup (NEW)	74-91	15001.18 *	19	Internal Mt.
3/4 Ton Pickup Truck & Ramcharger	80-93	15001.18 *	19	Internal Mt.	Mazda				
3/4 Ton Pickup Truck (NEW)	90-93	15001.39	30	Internal Mt.	B3000 & B4000	01-08	15001.70	27	Internal Mt.
1 Ton Pickup Truck w/Dana 60 (NEW)	90-93	15001.39	30	Internal Mt.	Navajo (NEW)	90-94	15001.65	27	5
Raider (NEW)	87-89	15001.43	28	6	Pickup Truck (NEW)	94-97	15001.65	27	5
Ford					Mitsubishi				
Bronco (Except Bronco II)	66-96	15001.18 *	19	Internal Mt.	Montero	82-92	15001.43	28	6
F100 1/2 Ton	59-86	15001.18 *	19	Internal Mt.	Nissan				
F150 1/2 Ton	59-96	15001.18 *	19	Internal Mt.	Patrol	80-87	15001.23	29	6
F250 3/4 Ton w/Dana 44	59-75	15001.18 *	19	Internal Mt.	Patrol	90-94	15001.45	31	6
F250 3/4 Ton w/Dana 44HD (NEW)	63-77	15001.17	19	6	Pickup Truck	86-93	15001.29	27	6
F250 3/4 Ton w/Dana 44	78-86	15001.18 *	19	Internal Mt.	Frontier V6	90-01	15001.61	28	6
F250 3/4 Ton w/Dana 60 (NEW)	78-97	15001.39	30	Internal Mt.	Pathfinder	86-89	15001.29	27	6
F350 1 Ton (NEW)	76-97	15001.39	30	Internal Mt.	Pathfinder V6	90-01	15001.61	28	6
F250 & F350 Super Duty (NEW)	99-04	15001.39	30	Internal Mt.	Xterra	00-04	15001.61	28	6
Ranger	98-00	15001.70	27	Internal Mt.	Suzuki Sidekick/Geo Tracker				
Ranger (NEW)	90-97	15001.65	27	Internal Mt.	Samurai & Sierra (NEW)	82-94	15001.38	26	6
Ranger (incl. 15001.65 , 15002.65) (NEW)	90-97	15003.65	27	Internal Mt. Kit	Sidekick & Vitara (NEW)	89-04	15001.38	26	6
Explorer (NEW)	90-94	15001.65	27	Internal Mt.	Toyota				
Ranger & Bronco II (NEW)	83-89	15001.67	23	5	Pickup Truck	76-85	15001.21	30	6
International					4 Runner	76-85	15001.21	30	6
Scout	60-71	15001.01	10	6	Pickup Truck, T100 (NEW)	86-00	15001.13	26	6
Scout II, Terra, Traveler	72-80	15001.02	27	6	4 Runner (NEW)	86-95	15001.13	26	6
1/2 Ton Pickup Truck (NEW)	56-67	15001.17	19	6	Tacoma*** (NEW)	95-00	15001.13	26	6
3/4 Ton Pickup Truck (NEW)	56-67	15001.17	19	6	Dana 70				
1/2 Ton Pickup Truck (NEW)	68-75	15001.18 *	19	Internal Mt.	Dana 70 Hub (NEW)	15001.97	35	Internal Mt.	
Travelall (NEW)	68-75	15001.18 *	19	Internal Mt.	Other Components				
Isuzu					Service Kit for 15001.65 Hub (NEW)	15002.65			
Trooper II (NEW)	87-99	15001.33	17	6	Service Kit for 15001.18 Hub (NEW)	15002.18			
Rodeo (NEW)	91-99	15001.33	17	6	*** (Replaces OE manual hubs)				
Amigo (NEW)	91-99	15001.33	17	6					

* Some models converting from automatic hubs may require service kit for installation.

** All Chevrolet pickup trucks built in 1988 were equipped with an automatic hub system which cannot be converted.

Part #'s 15001.39, .97, .13, .17, .67 & 15002.18 available 2010.

Extreme Heavy Duty (XHD) 2.0 & 2.5 Winches

Heavy-duty pulling capacity in a compact size, the Rugged Ridge Extreme HD ATV / UTV Winch helps you tackle the toughest terrain by providing unsurpassed pulling power for your ATV or Side by side on each and every pull. Beefy cast construction with powder coated finish and stainless hardware eliminates rust. Limited 3 year warranty.

Extreme HD 2.0 Winch

- Rated Line Pull: 2,000 lbs. (907 kgs.) single line
- Durable 12V 1.1 HP Permanent Magnet motor
- Tough Single Stage Planetary Gear box with a 153:1 gear ratio
- Includes 50' of 5/32" (4mm x 15.2m) diameter wire rope with detachable hook
- Mechanical load holding gear brake system
- High Performance 200 Amp Solenoid
- Pull and turn free spooling clutch



COMING SOON!

The Extreme HD 2.0 & 2.5 come with every thing you need to mount your winch and get back out on the trail: Four-way Roller Fairlead, Hand Held Remote, Winch Mounting Plate, Detachable Clevis Hook, 200 Amp Solenoid with wiring harness.

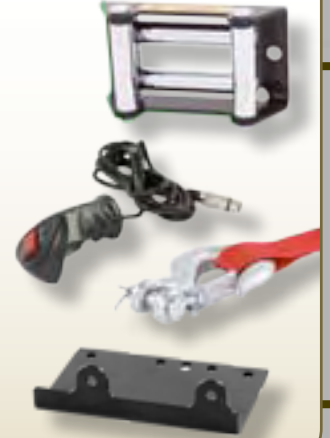

Extreme HD 2.5 Winch

- Rated Line Pull: 2,500 lbs. (1134 kgs.) single line
- Durable 12V 1.1 HP Permanent Magnet motor
- Tough Single Stage Planetary Gear box with a 153:1 gear ratio
- Includes 41' of 3/16" (4.8mm x 11m) diameter wire rope with detachable hook
- Mechanical load holding gear brake system
- High Performance 200 Amp Solenoid
- Pull and turn free spooling clutch
- Handle Bar Remote included

Extreme HD ATV/UTV Winches	Part #
Extreme HD 2.0 Winch, Each (NEW)	15100.50
Extreme HD 2.5 Winch, Each (NEW)	15100.55

Extreme Heavy Duty (XHD) 3.0/3.5/4.5 Winches

Rugged Ridge helps you tackle the toughest terrain by providing unsurpassed pulling power for your ATV or Side by side on each and every pull. It won't bog down like you buddy's winch because we sealed the motor and gear box to help keep mud and water out. A handle held and a handle bar remote come standard with each winch, putting you in control of your recovery situation. Beefy cast construction with powder coated finish and stainless hardware eliminates rust. Each Rugged Ridge Winch is backed by a limited three-year warranty.

Extreme HD 3.0 Winch

- Rated Line Pull: 3,000 lbs. (1360 kgs.) single line
- Durable 12V 1.2 HP Permanent Magnet motor
- Tough 3 Stage Planetary Gear box with a 138:1 gear ratio
- Sealed Motor and Gear Box helps keep mud and water out!
- Includes 50' of 3/16" (4.8mm x 15.2m) diameter wire rope with detachable hook
- Automatic load holding brake system (in the drum brake system)
- High Performance 200 Amp Solenoid
- Cam action free spooling clutch



COMING SOON!

The Extreme HD 3.0, 3.5, and 4.5 come with every thing you need to mount your winch and get back out on the trail: Four-way Roller Fairlead, Hand Held Remote, Handle Bar Remote, Winch Mounting Plate, Detachable Clevis Hook, 200 Amp Solenoid with remote wiring harness.



Extreme HD 3.5 Winch

- Rated Line Pull: 3,500 lbs. (1587 kgs.) single line
- Durable 12V 1.5 HP Permanent Magnet motor
- Tough 3 Stage Planetary Gear box with a 198:1 gear ratio
- Sealed Motor and Gear Box helps keep mud and water out!
- Includes 50' of 7/32" (5.5mm x 15.2m) diameter wire rope with detachable hook
- Automatic load holding brake system (in the drum brake system)
- High Performance 200 Amp Solenoid
- Cam action free spooling clutch

Extreme HD 4.5 Winch

- Rated Line Pull: 4,500 lbs. (2041 kgs.) single line
- Durable 12V 2.0 HP Permanent Magnet motor
- Tough 3 Stage Planetary Gear box with a 138:1 gear ratio
- Sealed Motor and Gear Box helps keep mud and water out!
- Includes 44' of 6/25" (6.0mm x 13.7m) diameter wire rope with detachable hook
- Automatic load holding brake system (in the drum brake system)
- High Performance 200 Amp Solenoid
- Cam action free spooling clutch

COMING SOON!

Extreme HD ATV/UTV Winches	Part #
Extreme HD 3.0 Winch, Each (NEW)	15100.60
Extreme HD 3.5 Winch, Each (NEW)	15100.65
Extreme HD 4.5 Winch, Each (NEW)	15100.70

Replacement Synthetic Winch Ropes For ATV/UTV

Stronger and lighter, the two key elements of Synthetic Rope that make it the choice of competition off road vehicles everywhere. Rugged Ridge high strength Synthetic Winch Rope is constructed from genuine Dyneema SK-75 fiber imported from the Netherlands. This revolutionary fiber is the choice of off-road enthusiast worldwide. It is stronger and lighter than wire rope and never kinks or splinters! Our synthetic line is woven from twelve UV-treated strands, resulting in increased strength, and a power to weight ratio unmatched by wire rope. Each synthetic rope comes with a protective sleeve that prevents it from over heating on the winch drum, black powder coated latched hook, stainless steel thimble, and is pre-terminated end for ease of installation. Synthetic rope does not store energy like steel cables, and in the event of a failure it is much less likely result severe injuries caused by the whiplash of broken wire rope. Each replacement rope kits can be easily attached to your current winch by removing your current steel cable and roller fairlead. A new Hawse Fairlead will be required for use with Synthetic Rope

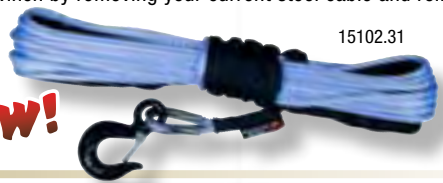

15102.31

Synthetic Winch Ropes	Part #
Synthetic Winch Rope 3/16" x 50', UTV,ATV, Breaking Force of 4,600 lbs., Each (NEW)	15102.30
Synthetic Winch Rope 1/4" x 50', UTV, ATV, Breaking Force of 8,400 lbs., Each (NEW)	15102.31



Aluminum Hawse Fairlead

This hawse fairlead will help guide the synthetic winch rope to and from the spool. The Rugged Ridge UTV hawse fairlead features the Rugged Ridge logo etched into the top to show your loyalty to your favorite brand! Includes hardware.

NEW!

Aluminum Hawse Fairlead	Part #
Aluminum Hawse Fairlead for UTV, Each (NEW)	61238.01

Recovery Gear Kits

Includes everything you need to help your buddy next time he gets stuck in the mud. The durable carrying case is filled with our most popular recovery products to make sure you can get out of those trouble spots quickly and safely.

Recovery Gear Kits	Part #
The Ultimate ATV / UTV Recovery Gear Kit, Each (NEW)	15104.26
The Lite ATV / UTV Recovery Gear Kit, Each (NEW)	15104.27



The Lite Kit

- A. Durable Recovery Gear Bag.
- B. Heavy Duty 8" 20,000lb Snatch Block Pulley.
- C. Premium 1" x 15' 10,000lb Recovery Strap.
- D. Premium 6" x 6' 20,000lb Tree trunk Protector Strap.
- E. One Heavy Duty 6,000lb zinc coated D-Ring.
- F. Tire Repair Kit in soft sided carrying case*.

The Ultimate Kit

- A. Durable Recovery Gear Bag.
- B. Heavy Duty 8" 20,000lb Snatch Block Pulley.
- C. Premium 1" x 15' 10,000lb Recovery Strap.
- D. Premium 6" x 6' 20,000lb Tree trunk Protector Strap.
- E. Pair of Heavy Duty 6,000lb zinc coated D-Rings.
- F. Tire Repair Kit in soft sided carrying case*.
- G. Winch Line Dampener.
- H. Pair of leather Recovery Gloves.

* Tire repair Kit contains: (10) Tire Plugs, (1) Aluminum Handle, (1) Reamer Attachment, (1) Needle Attachment, and (1) Allen Wrench.

TRI FOLD RECOVERY SHOVEL, UNIVERSAL APPLICATION

The Rugged Ridge Tri Fold Recovery Shovel is a fully functional collapsible shovel that features two serrated edges for cutting or digging. The heavy duty black powder coated body is 23 inches when open and folds to a mere 9 inches. It can be stowed easily in any vehicle, but is still rugged enough for the toughest of jobs. Includes durable storage case.



Rugged Ridge Tri-Fold Recovery Shovel	Part #
Tri-Fold Recovery Shovel, Each (NEW)	15104.42



Winch Cable Grab Handle

The winch hook handle is the perfect solution for handling a winch cable. It is constructed of tough nylon webbing with a molded sure-grip handle. Perfect for getting a good solid grip of the winch hook when free spooling cable for a recovery. Safely spool in your in winch cable without putting your hands at risk. Just slip your winch hook through the nylon webbing and you are ready to rock!

Winch Cable Grab Handle	Part #
Ultimate Winch Grab Handle Strap, Black, Universal Application, Each (NEW)	15102.01

ATV/UTV Accessories

UTV Grab Handles

Four styles to choose from: Dual, Ultimate, Deluxe and Sport. Dual, Ultimate and Deluxe models include Sure Grip Handles. The Dual UTV Grab Strap gives passengers a place to hold on while on the trail. Constructed of durable nylon webbing with soft molded foam handles for ease of use and comfort. Easily attaches with hook and loop around the center roll bar, no drilling required. Special side "Pockets" create a handy spot for hanging clothes. Special two handle design gives passengers a place to hang on during those off road adventures. All handles are custom designed to fit UTV Roll bar widths from 1" to 1½".



63305.04 Ultimate Grab Handle

Grab Handles	Part #
Dual UTV Grab Strap, Black, Each	63305.05
Ultimate UTV Grab Handles, Black, Pair	63305.04
Ultimate UTV Grab Handles, Red, Pair	63305.03
Sport UTV Grab Handles, Black, Pair	63305.01
Deluxe UTV Grab Handles, Black, Pair	63305.02

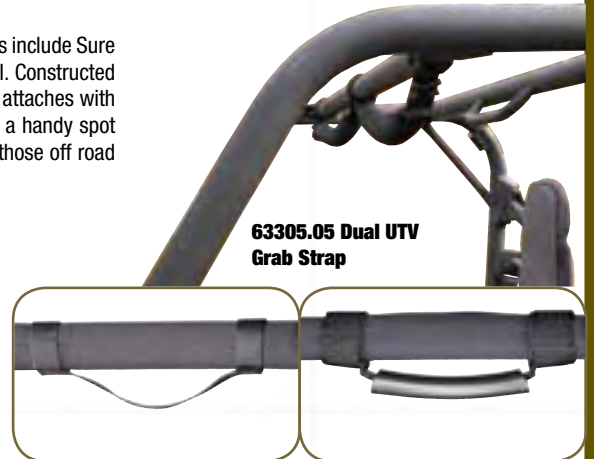

63305.05 Dual UTV Grab Strap



63305.01 Sport Grab Handle



63305.02 Deluxe Grab Handle

Neoprene Handle Kit



Neoprene Handle Kit Part #

For Yamaha Rhino, Black, 6 pc. Kit	63305.50
For Yamaha Rhino, Red, 6 pc. Kit	63305.51

Wheel Spacers for Yamaha® Rhino

These spacers space your wheels out an extra 1.75" to help fit wider tires and give your vehicle a wider track and improve stability. Constructed of double anodized black extra thick 6061T6 Aluminum for long life and extra corrosion resistance. All hardware is grade 8 for extra strength.



Wheel Spacers Part #

1.75" Wheel Spacers for Yamaha Rhino, Pair	65201.05
--	----------

Fire Extinguisher Holder

Thick nylon web straps are fully adjustable and secure with hook and loop fasteners. Works with both 1" and 1½" roll bars with or without padding. Holds one 3 lb fire extinguisher (not included).



Fire Extinguisher Holder Part #

Fits all 1"-1.5" Roll Bars, Black, Each	63305.21
Fits all 1"-1.5" Roll Bars, Red, Each	63305.20

Roll Bar Drink Holder



Custom designed to place a handy drink holder anywhere along your vertical roll bar. Constructed of durable nylon covered foam with heavy-duty Velcro and nylon straps to secure it to the roll bar. Foam insulates your drink, keeping it cool.

Roll Bar Drink Holder Part #

Fits all 1"-1.5" Roll Bars, Pair	62101.51
----------------------------------	----------

Rear View Mirror

This rear view mirror clamps to the roll bar of any UTV. Get the same visibility you are used to in your car in an easy to install package.



Rear View Mirror Part #

Fits all 1"-1.5" Roll Bars, Each	61020.01
----------------------------------	----------

Winch Plate for Yamaha® Rhino

Heavy-duty steel construction, and durable black powder coat finish for longevity. Fits all standard mount UTV winches.



Winch Plate Part #

For Yamaha Rhino, Each	61238.10
------------------------	----------

Roll & Pitch Meter

This Roll & Pitch Meter (Clinometer) features two gauges: left displays side to side angle & right displays front to back angle. Each display has a graphic readout that shows angles in degrees for quick reference. The Clinometer attaches to the dash with automotive grade double sided tape or can be permanently mounted with screws.



Roll & Pitch Meter Part #

Clinometer, UTV Graphic, Compass Model, Each	63309.01
--	----------

Roll Bar Storage Bag

This bag allows the storage of all your recovery gear and other important items between the A frame uprights on your Yamaha® Rhino. Constructed of weather resistant material with a zipper flap to help protect your gear from the environment. Attaches easily with four heavy-duty nylon straps allowing for quick removal and transport using the attached grab handle.



Roll Bar Storage Bag Part #

For Yamaha Rhino, Each	62801.50
------------------------	----------

Off road Organizer

Custom design for use in even the smallest glove boxes. Special pockets allow you to effectively organize manuals, maps, tire gauges, vehicle registration and more. Constructed of durable nylon in a tri-fold configuration.



Off road Organizer Part #

Fits all UTV Glove Boxes, Each	13305.06
--------------------------------	----------

With over 50 UTV parts available and more on the way, Rugged Ridge has the trick parts you need to make your UTV truly unique. Whether it's a work vehicle, a hunting rig, a hunting rig, or an off road toy, you want to make the most out of your investment - accessorizing with Rugged Ridge is the way to do it! Whether it's seat covers, grab handles or a full blown cab enclosure, Rugged Ridge has you covered for all your UTV accessory needs.



63570.01 Nylon Summer Brief, Yamaha Rhino

Nylon/Mesh/Fabric Summer Briefs for Yamaha® Rhino

Keep the sun off your Rhino's interior while keeping you cool and protected from the elements with a Summer Brief from Rugged Ridge. Constructed of your choice of nylon, sun stop mesh or durable soft top. All Summer Briefs are custom fit for Yamaha® Rhino and install with nylon web straps with snaps (drilling required). Soft top fabric version is available in Diamond Khaki or Diamond Black for the ultimate look. Sun stop mesh fabric blocks out the heat of the sun while still keeping that open air feel.



63575.01 Mesh Summer Brief Yamaha Rhino



EXCLUSIVE! Storage Pockets built into each Summer Brief



63701.36 Fabric Summer Brief Yamaha Rhino

Nylon/Mesh/Fabric Summer Briefs	Part #
Nylon Bikini Top w/Zippered Pockets, Diamond Black, Each	63570.01
Mesh Bikini Top w/Zippered Pockets, Diamond Black, Each	63575.01
Fabric Bikini Top w/Zippered Pockets, Diamond Black, Each	63701.35
Fabric Bikini Top w/Zippered Pockets, Diamond Khaki, Each	63701.36

Cab Enclosure for Yamaha® Rhino



63310.01 Cab Enclosure/Soft Top, Black Denim Fabric, for Yamaha Rhino

The Rugged Ridge Cab Enclosure is a complete soft top that fits over the roll cage to offer protection from the elements. Rugged Ridge is the premier supplier of soft tops for Jeep and other off road vehicles. We have used that engineering and research experience to craft the most durable UTV top available. Each Enclosure features the same automotive grade crystal clear DOT approved window glass, welded heat seams, vinyl coated polyester, and cotton fabric we use in our Jeep tops! Includes zipper storage pockets and zip out windows.

Cab Enclosure/Soft Top	Part #
Black Denim Fabric, for Yamaha Rhino, Each	63310.01

Tonneau Cover for Yamaha® Rhino



This durable tonneau cover keeps the contents of your UTV's bed safe from rain, snow, hail and mud. It opens quickly and easily for access to your bed and as a bonus it adds a smooth look to your UTV.

Tonneau Cover	Part #
For Yamaha Rhino, Each	63315.01

Front Fender Guards for Yamaha® Rhino



Heavy-duty 12 gauge steel construction keeps rocks and debris from damaging your plastic inner fenders. Corrosion resistant finish. This is a must buy for anyone who takes their UTV off road!

Front Fender Guards	Part #
For Yamaha Rhino, Pair	62004.01

Custom Seat Covers for Yamaha® Rhino

These covers are constructed of durable neoprene or soft poly-cotton front and back for the best looking seat cover available. Rugged Ridge does not use cheap stretch nylon on their seat covers! Soft poly-cotton protects and prevents the original vinyl seat from getting over heated, no more burned legs! Neoprene (wetsuit material) is a great fabric to protect your seats from dirt, water and whatever mother nature can throw at you. Each cover is custom tailored for your Rhino's original equipment seat style making your seats look like they have been recently reupholstered. Installation is easy with special designed elastic cords, and nylon straps that attach to your seat and to the seat cover mounting points. Available in light grey or black to match the interior of your UTV. Packed in pairs with headrest covers.

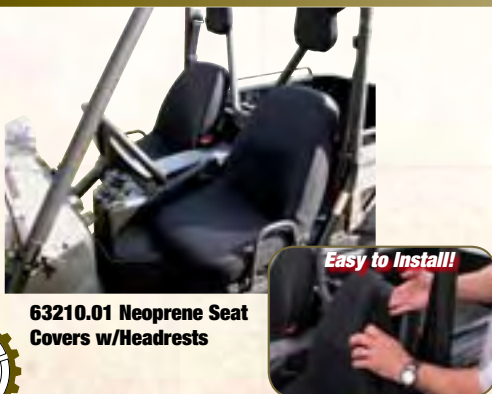

Easy to Install!

63210.01 Neoprene Seat Covers w/Headrests

Seat Covers with Headrests	Part #
Neoprene Seat Covers w/Headrest, Black, Pair	63210.01
Neoprene Seat Covers w/Headrest, Grey, Pair	63210.09
Fabric Seat Covers w/Headrest, Black, Pair	63240.01
Fabric Seat Covers w/Headrest, Grey, Pair	63240.09

Drivetrain Engineering Perfected



Are you looking for an axle or ring and pinion rugged enough to match your off the beaten path sense of adventure? Alloy USA® axle shafts and Precision Gear® ring & pinions have been propelling muscle cars, trucks and four wheel drive vehicles down highways, drag strips, back roads and over the world's roughest terrain for nearly a decade. With the recent asset and intellectual property purchase of Alloy USA® and Precision Gear® by Ultra Axle LLC, an affiliate of Omix-Ada® Inc., these two brands are now backed by an industry leading, financially strong company that will be there for you in the long haul. As a member of the Omix-Ada® group of companies Alloy USA® and Precision Gear® will provide the service and support you demand! The dedicated team of Alloy USA® and Precision Gear® engineers have developed, tested, raced and trail ridden each of our products until they were perfected. We marry the mechanics of engineering with the art of manufacturing to produce the finest in drivetrain solutions. High tensile strength 4340 Chromoly is heat-treated, tempered and induction hardened to produce these heavy-duty axles that are up to 40% stronger than stock. We use the latest splining technology to produce splines that are stronger than traditional cut splines. The shafts are then precision CNC machined and magnaflux inspected for cracks before receiving the Alloy USA® logo and a slick black anodized or natural finish.

Why have we put so much time and energy into developing our Axle Shafts and Ring & Pinions? Because horsepower is useless if you can't get it to the ground. We take pride in engineering solutions and prove it by backing each product with an industry leading warranty. Each axle is covered by our exclusive 10-year limited warranty and each ring and pinion is covered by a 5-year limited warranty so you can drive with confidence!

WELCOME TO THE NEW ALLOY USA® & PRECISION GEAR®!

THE BEST WARRANTY IN THE BUSINESS

Alloy USA®/Precision Gear® Limited Warranty

Your Alloy USA® or Precision Gear® product is covered by the Limited Warranty explained below that gives you specific legal rights. This limited warranty is the only warranty Ultra Axle® LLC (the distributor/warrantor of these products) makes in connection with your purchase. Ultra Axle® LLC neither assumes nor authorizes any vendor, retailer or other person or entity to assume for it any other obligation or liability in connection with its products or Limited Warranty.

What is covered? Subject to the terms, exclusions and limitations herein and with respect only to products first sold in the United States, Ultra Axle® LLC warrants to the initial retail purchaser only that products sold under its Alloy USA® and Precision Gear® trademarks including Axle Shafts, Ring and Pinions, Installation Kits, Jeep® Overhaul Kits, Alloy USA® X Joints and Differential Covers shall be free of defects in material and workmanship for the Limited Warranty term/duration described below. This Limited Warranty shall be measured from the date of initial retail purchase, extends only to the initial retail purchaser and is not transferable. All other express or implied warranties are hereby disclaimed. Your warrantor for these parts is Ultra Axle® LLC, 460 Horizon Dr., Suite 400 Suwanee, GA 30024 (770/614-6101). Ultra Axle® reserves the right to: (a.) require proof of purchase as a condition of this Limited Warranty, (b.) make future revisions to its Limited Warranty without prior notice.

Duration of Limited Warranty by Product Line

Alloy USA®, front and rear axles- **10 Year Limited Warranty**

Precision Gear® and Alloy USA® Ring and Pinions- **5 Year Limited Warranty**

Jeep® Overhaul kits, Alloy USA® X Joints, Tube Seals and Differential Covers- **3 Year Limited Warranty**

What is not covered: Your Alloy USA®, Precision Gear® Limited Warranty does not cover damage or claims to any component, vehicle or person other than Alloy USA® or Precision Gear® parts purchased by the initial retail purchaser. Your Alloy USA®, Precision Gear® Limited Warranty does not cover damage or claims to any component, vehicle or person Ultra Axle® LLC determines to have been damaged by or subjected to:

- Installation damage, alteration, modification, misuse or failure to maintain.
- Products used in application other than those recommended in the current Alloy USA®/Precision Gear® catalog or the instructions accompanying your Alloy USA®/Precision Gear® product.
- Normal wear and tear/product life deterioration, scratches or defects in product finishes (powder coating, plating, etc.) or damage due to shipping.
- Damage arising or related to non- Ultra Axle® LLC products including but not limited to any vehicle's electronic stability system, related components or other vehicle systems.
- Accidents, impact by rocks, trees, obstacles or other aspects of the use environment.
- Theft, vandalism or other intentional damage.

Remedy Limited to Repair / Replacement. The exclusive remedy provided hereunder shall, upon Ultra Axle® LLC inspection and at Ultra Axle® LLC option, be either repair or replacement of the Ultra Axle® LLC parts covered under this Limited Warranty. Customers requesting warranty consideration should first contact the independent distributor selling your part to obtain a Returned Goods Authorization number. All removal, shipping and installation costs are customer's responsibility. If a replacement part is needed before the Ultra Axle® LLC part can be returned, you must first purchase the replacement part. Then, if Ultra Axle® LLC determines the part warrantable, you will be credited the purchase price of that part.

Other Limitations - Exclusion of Damages - Your Rights Under State Law

- In consideration of the purchase price paid, neither Ultra Axle® LLC nor any independent distributor are responsible for any loss of use or time, rental costs, or for any incidental, consequential, punitive or other damages you may have or incur in connection with your vehicle or any Ultra Axle® LLC product. Your exclusive remedy for Ultra Axle® LLC parts covered hereunder is repair/replacement as described above.
- This Limited Warranty gives you specific rights. You may also have other rights that vary from state to state. For example, while all implied warranties are disclaimed herein, any implied warranty required by law is limited to the duration and other enforceable terms of Limited Warranty described above. Some states do not allow limitations of how long an implied warranty lasts and/or do not allow the exclusion or limitation of incidental or consequential damages, so the limitations and exclusions herein may not apply to you.

© Ultra Axle® LLC Axle LLC. 1.3.2010. All Rights Reserved.

Jeep® is a registered trademark of Chrysler LLC. Ultra Axle® LLC is an independent aftermarket vendor not affiliated with any vehicle manufacturer. Pro Gear® and Ultralite Gears and Differentials® are additional trademarks of Ultra Axle® LLC.



Chrysler®, Chevrolet®, Dodge®, GM®, Ford®, Jeep®, International® & other names used here are trademarks of their respective owners and are used within this publication for identification purposes only. Alloy USA® is not affiliated with these companies. The information in this catalog is believed to be correct at the time of publishing. The publisher is not responsible for any losses, direct or indirect, that are the result of any information within this publication. Alloy USA® and Precision Gear® and their corresponding logos are trademarks of Ultra Axle®, LLC. OMIX-ADA® and its corresponding logo are registered trademarks of OMIX-ADA®, Inc. ®Registered 2010, Ultra Axle®, LLC. All rights reserved.

Lock Right® Lockers

The Powertrax Lock-Right Lockers performance is equal to a solid spool axle, yet automatically unlocks to allow full differentiation in turns. The locker also reduces the excessive noise, tire wear, and drivetrain damage associated with other lockers. Powertrax lockers replace the spider gears in your differential carrier without affecting your ring and pinion settings. The whole job can be done in your driveway with common hand tools in a couple of hours. A carrier is not included. Whether it be snow, sand, mud, ice, etc... the LOCK-RIGHT will give you the traction you need.

APPLICATION	ALLOY #
LOCK RIGHT FRONT 1945-64 CJ 'S DANA-25 & 1964-71 CJ DANA-27	LR2115
LOCK RIGHT FRONT 1972-03 CJ, YJ, TJ	LR2210
LOCK RIGHT REAR 1945-49 CJ 'S WITH DANA-41	LR2416
LOCK RIGHT REAR 1945-62 CJ 'S WITH 10-SPLINE DANA-44	LR2415
LOCK RIGHT REAR 1955-69 CJ 'S WITH 19-SPLINE DANA-44	LR2413
LOCK RIGHT REAR 1970-86 CJ 'S WITH 30-SPLINE DANA-44, ALSO 1997-02 TJ	LR2410
LOCK RIGHT REAR 1976-86 CJ 'S WITH AMC-20	LR1710
LOCK RIGHT REAR 1987-93 YJ DANA-35 (EXCEPT 1993 W/ 605528 BOM) (PLUS Z-SHAFT)	LR2310S
LOCK RIGHT REAR 1994-03 YJ & TJ DANA-35 (ALSO 1993 YJ 605528 BOM) (PLUS Z-SHAFT)	LR2311S
LOCK RIGHT CHRYSLER 8.25" 12-BOLT 31-SPLINE	LR1220
LOCK RIGHT CHRYSLER 8.25" 10-BOLT 27-SPLINE	LR1230
LOCK RIGHT ZYTANIUM CROSSSHAFT, REAR AMC-20	LRSA1710
LOCK RIGHT ZYTANIUM CROSSSHAFT, FRONT DANA-30	LRSD2210
LOCK RIGHT ZYTANIUM CROSSSHAFT, REAR DANA-44	LRSD2410



Detroit Lockers®



APPLICATION	ALLOY #
DETROIT LOCKER, TRUETRAC, LIMITED SLIP DIFFERENTIAL, DANA 35 27 SPLINE 3.54 TO 5.38 GEAR RATIO, JEEP WRANGLER (YJ) 87-95, (TJ) 97-06, CHEROKEE (XJ) 84-01, GRAND CHEROKEE (ZJ) 93-98, (WJ) 99-04	912A569
DETROIT LOCKER, LIMITED SLIP DIFFERENTIAL, DANA 35 27 SPLINE 3.54 TO 5.38 GEAR RATIO, JEEP WRANGLER (YJ) 87-95, (TJ) 97-06, CHEROKEE (XJ) 90-01	162C56A
DETROIT LOCKER, LIMITED SLIP DIFFERENTIAL, DANA 35 30 SPLINE 3.54 TO 5.38, JEEP WRANGLER (YJ) 87-95, (TJ) 97-06, CHEROKEE (XJ) 90-01	162C66A
DETROIT LOCKER, DIFFERENTIAL, SUPER DANA 44 33 SPLINE 3.92 + GEAR RATIO, JEEP 66-68	187SL192A
DETROIT LOCKER, TRUETRAC, LIMITED SLIP DIFFERENTIAL, DANA 30 27 SPLINE 3.07 TO 3.54 GEAR RATIO, JEEP CJ 72-86, WRANGLER (YJ) 87-95, (TJ) 97-06, CHEROKEE (XJ) 84-01, GRAND CHEROKEE (ZJ) 93-98	912A584
DETROIT LOCKER, TRUETRAC, LIMITED SLIP DIFFERENTIAL, DANA 44 30 SPLINE 2.73 TO 3.73 GEAR RATIO, JEEP CJ5 70-75, CJ7 86, WRANGLER (TJ) 97-06	913A589
DETROIT LOCKER, TRUETRAC, LIMITED SLIP DIFFERENTIAL, DANA 44 30 SPLINE 3.92 TO 5.38 GEAR RATIO, JEEP CJ5 70-75, CJ7 86, WRANGLER (TJ) 97-06	913A590
DETROIT LOCKER, TRUETRAC, LIMITED SLIP DIFFERENTIAL, DANA 44 FRONT 30 SPLINE 2.73 TO 3.73 GEAR RATIO, JEEP WRANGLER (TJ) 03-06	913A591
DETROIT LOCKER, SOFT LOCKER, LOCKING DIFFERENTIAL, DANA 30 3.73 TO 5.38 RATIO, JEEP CJ 72-86, WRANGLER (YJ) 87-95, (TJ) 97-06, CHEROKEE (XJ) 84-01, GRAND CHEROKEE (ZJ) 93-98, (WJ) 99-02,	162SL60B
DETROIT LOCKER, SOFT LOCKER, LOCKING DIFFERENTIAL, AMC 20 3.08 TO 4.88 RATIO, JEEP CJ 76-86	187SL47A
DETROIT LOCKER, SOFT LOCKER, LOCKING DIFFERENTIAL, DANA 44 3.92 TO 5.38 RATIO, 30 SPLINE, JEEP CJ 70-75 & 86, WRANGLER (TJ) 97-06, CHEROKEE (XJ) 84-01, GRAND CHEROKEE (ZJ) 93-98, (WJ) 99-02	187SL16C
DETROIT LOCKER, SOFT LOCKER, LOCKING DIFFERENTIAL, DANA 44 30 SPLINE 2.73 TO 3.73 GEAR RATIO, JEEP CJ5 70-75, CJ7 86, WRANGLER (TJ) 97-06	187SL16D
DETROIT LOCKER, TRUETRAC, LIMITED SLIP DIFFERENTIAL, DANA 30 3.73 TO 5.38 RATIO, JEEP CJ 72-86, WRANGLER (YJ) 87-95, (TJ) 97-06, CHEROKEE (XJ) 84-01, GRAND CHEROKEE (ZJ) 93-98, (WJ) 99-02,	912A314

ARB® Lockers



APPLICATION	ALLOY #
ARB AIR LOCKER, 1970-03 CJ, MJ, TJ, ZJ, WJ, SJ DANA 44 30 SPLINE 3.92 & UP RATIO	ARB-RD06
ARB AIR LOCKER, 1970-03 CJ, MJ, TJ, ZJ, WJ, SJ DANA 44 30 SPLINE 3.73 & DOWN RATIO	ARB-RD07
ARB AIR LOCKER, 1972-03 CJ, XJ, YJ, TJ, ZJ, WJ DANA 30 27 SPLINE 3.73 & UP RATIO	ARB-RD100
ARB AIR LOCKER, 1972-03 CJ, XJ, YJ, TJ, ZJ, WJ DANA 30 27 SPLINE 3.54 & DOWN RATIO	ARB-RD101
ARB AIR LOCKER, 1976-86 CJ & SJ AMC 20 29 SPLINE 3.08 & UP RATIO	ARB-RD60
ARB AIR LOCKER, 1990-03 YJ, TJ, XJ, ZJ DANA 35 W/C-CLIP 27 SPLINE 2.73-3.31 RATIO	ARB-RD103
ARB AIR LOCKER, 1990-03 YJ, TJ, XJ, ZJ DANA 35 W/C-CLIP 27 SPLINE 3.54 & UP RATIO	ARB-RD102
ARB AIR LOCKER, 1997-UP ZJ, WJ, KJ CHRYSLER 8.25" 29 SPLINE, ALL RATIOS	ARB-RD93
ARB AIR LOCKER, SUPER DANA 30, 3.73 AND UP RATIO	ARB-RD104
ARB AIR LOCKER, SUPER DANA 35, C-CLIP, 30 SPL, 3.54 AND UP RATIO	ARB-RD105

10 TEN YEAR
MANUFACTURER WARRANTY



Front Axle Kits

High tensile strength 4340 Chromoly is heat-treated, tempered and induction hardened to produce these heavy-duty axles that are up to 40% stronger than stock 1040 axles. Each axle shaft is backed by Alloy USA's™ exclusive ten-year warranty! We use the latest splining technology to produce splines that are stronger than traditional cut splines. The shafts are then precision CNC machined and magnaflux inspected for cracks before receiving a slick black anodized finish. Our front axle shaft kits include everything you need to complete the job: both passenger and drive side inner and outer axle shafts, seals, U-joints and clips.



APPLICATION	ALLOY #	INNER	OUTER	RING
JEEP® Complete Inners/Outers with U-Joints & Clips				
Jeep CJ5 72-83, CJ7 & CJ8 76-81, Dana 30 Grande 30-Spline Kit (Narrow-Trac Kit) ³	12129	30	27	D30
Jeep CJ5 72-83, CJ7 & CJ8 76-81, Dana 30 Grande 30-Spline Kit With ARB Locker (Narrow-Trac Kit)	12129-ARB	30	27	D30
Jeep CJ7 & CJ8, 82-86, Dana 30 Grande 30-Spline Kit (Wide-Trac Kit) ³	12130	30	27	D30
Jeep CJ7 & CJ8, 82-86, Dana 30 Grande 30-Spline Kit With ARB Locker (Wide-Trac Kit)	12130-ARB	30	27	D30
Jeep CJ5 72-83, CJ7 & CJ8 76-81, Dana 30 27-Spline Kit (Narrow-Trac Kit)	12139	27	27	D30
Jeep CJ7 & CJ8 82-86, Dana 30 27-Spline Kit (Wide-Trac Kit)	12142	27	27	D30
Jeep Wrangler (YJ) 87-95, Cherokee (XJ) 84-91, Dana 30 30-Spline Kit (NEW)	12131	30	27	D30
Jeep Wrangler (YJ) 87-95, Cherokee (XJ) 84-91, Dana 30 30-Spline Kit w/ARB Locker (NEW)	12131-ARB	30	27	D30
Jeep Wrangler (YJ) 87-95, Cherokee (XJ) 84-91, Dana 30 Grande 30/30-Spline Kit (30-Spline Inners & Outers) (NEW)	12231	30	30	D30
Jeep Wrangler (YJ) 87-95, Cherokee (XJ) 84-91, Dana 30 Grande 30/30-Spline Kit w/ ARB Locker (30-Spline Inners & Outers) (NEW) ²	12231-ARB	30	30	D30
Jeep Wrangler (YJ) 87-95, Cherokee (XJ) 84-91, Dana 30 27-Spline Kit (Disconnect Eliminator)	12145	27	27	D30
Jeep Wrangler (TJ) 97-06, Cherokee (XJ) 92-01, Dana 30 Grande 30-Spline Kit (NEW) ³	12132	30	27	D30
Jeep Wrangler (TJ) 97-06, Cherokee (XJ) 92-01, Dana 30 Grande 30-Spline Kit w/ ARB Locker (NEW)	12132-ARB	30	27	D30
Jeep Wrangler (TJ) 97-06, Cherokee (XJ) 92-01, Dana 30 Grande 30/30-Spline Kit (30-Spline Inners & Outers) (NEW) ^{1,2,3}	12232	30	30	D30
Jeep Wrangler (TJ) 97-06, Cherokee (XJ) 92-01, Dana 30 Grande 30/30-Spline Kit w/ ARB Locker (30-Spline Inners & Outers) (NEW) ^{1,2}	12232-ARB	30	30	D30
Jeep Wrangler (TJ) 97-06, Cherokee (XJ) 92-01, Dana 30 27-Spline Kit	12148	27	27	D30
Jeep Wrangler (TJ) Rubicon 03-06, Dana 44 Grande 30-Spline Kit (NEW)	12165	30	27	D30
Jeep Wrangler (TJ) Rubicon 03-06, Dana 44 30/30-Spline Kit (30-Spline Inners & Outers) (NEW) ¹	12265	30	30	D44
Jeep Wrangler (JK) 07-10, Dana 30 27-Spline Kit (NEW)	12152	27	32	D30
Jeep Wrangler (JK) Rubicon 07-10, Dana 44 30-Spline Kit (NEW) ⁴	12155	30	32	D44
Jeep Wagoneer (SJ) 74-79, Dana 44 30-Spline Kit ⁴	12171	30	19	D44
Jeep Wagoneer (SJ) 80-92, Dana 44 30-Spline Kit ⁴	12174	30	19	D44

¹ NOTE: This kit includes upgraded 30 spline bearing hub units.

² NOTE: When converting to 30 spline outer axles, 1999 and older models must use the 2000-06 Wrangler rotor (Omix 16702.05).

³ NOTE: Upgrade to 30 spline locker required.

⁴ NOTE: Not available at the time of this printing. Will be announced when available.

Grande Outer Stub Upgrade

Grande 30 spline outer stub upgrade replaces factory 27 spline outer stub axles to 30 spline.

Kit includes:

- 2 - 30 Spline Chromoly Axle Stub Shafts
- 2 - 30 Spline Unit Bearings
- 2 - Alloy X-Joints



APPLICATION	ALLOY #
Jeep Wrangler (YJ, TJ) 87-06, Cherokee (XJ) 84-01, 30-Spline Outer/Unit Bearing Upgrade Kit	12168

NOTE: When converting to 30 spline outer axles, 1999 and older models must use the 2000-06 Wrangler brake rotor (Omix 16702.05).

3 THREE YEAR
MANUFACTURER WARRANTY



TEN YEAR
MANUFACTURER WARRANTY **10**

Front Axle Kits

APPLICATION	ALLOY #	INNER	OUTER	RING
GM Complete Inners/Outers with U-Joints & Clips				
GM 1/2-Ton Pickup, Suburban, Blazer, Jimmy 77-87, 8.5" 30-Spline Kit	12170	30	19	GM 8.5
GM 1/2-Ton Pickup, Suburban, Blazer, Jimmy 73-78, Dana 44 30-Spline Kit ⁴	12172	30	19	D44
FORD Complete Inners/Outers with U-Joints & Clips				
Ford F150 68-79, Bronco 78-79, Dana 44 30-Spline Kit ⁴	12175	30	19	D44
Ford F250 68-79, Dana 44 30-Spline Kit	12176	30	19	D44
Ford Bronco 71-77, Dana 44 30-Spline Kit ⁴	12177	30	19	D44
INTERNATIONAL Complete Inners/Outers with U-Joints & Clips				
International Scout 71-80, Dana 44 30-Spline Kit ⁴	12173	30	27	D44

Front Dana 60 Shafts

Our Dana 60 shafts feature the same high strength 4340 Chromoly shafts used in our front axle kits. These heavy-duty shafts are 40% stronger than OE and are made to stand up to abuse. You run a Dana 60 because you wanted the strength, don't let weak 30 spline axles ruin your day. Upgrade to our 35 spline count axles and wheel with confidence. Each Alloy USA™ axle is backed by an industry leading 10-year warranty. We use the latest splining technology to produce splines that are stronger than traditional cut splines. Our shafts are heat-treated, tempered and induction hardened to produce these heavy-duty axles that are up to 40% stronger than stock.

APPLICATION	ALLOY #	SIDE	LENGTH	SPLINE	MODEL
DODGE					
Dana 60 Chromoly Inner Axle Shaft ⁵	10662	RH	15.97"	35	D60
Dana 60 Chromoly Inner Chevy/Dodge ⁴	10661	LH	35.10"	35	D60
FORD					
Dana 60 78-79 Ford 18.68 LH Chromoly 35-Spline ⁵	10663	LH	18.68"	35	D60
Dana 60 78-79 Ford 34.56 RH Chromoly 35-Spline ⁵	10664	RH	34.56"	35	D60
Dana 60 Chromoly Inner Axle Shaft, 83-91 Ford, LH, Inner, 35-Spline ⁵	10662	LH	15.97"	35	D60
Dana 60 Ford 83-91 36.68 RH Inner 35-Spline Chromoly ⁵	10665	RH	36.68"	35	D60
FORD Outer Stub Axles					
Dana 60 Chromoly Ford Outer Unit Bearing 35-Spline ⁵	10652	NA	10.5"	35	D60
Dana 60 Ford Style Front Outer - 4340 Chromoly ⁵	10651	NA	11.40"	35	D60
GM					
Dana 60 Chromoly RH Inner Axle Shaft Chevy ⁵	10660	RH	17.67"	35	D60
Dana 60 Chromoly LH Inner Chevy/Dodge ⁴	10661	LH	35.10"	35	D60
GM Outer Stub Axles					
Dana 60 GM Style Front Outer - 4340 Chromoly ⁴	10650	NA	12"	35	D60

Front & Rear Dana 60 "Builders" Shafts

Our Dana 60 "Builders" shaft put you in charge of your build. Available in custom lengths and heavy-duty 35 spline upgraded applications. Our front shafts are made from bullet proof 4340 Chromoly and the rears from high tensile strength 4140. 4140 alloy axles are perfect for handling the load when twisting torque is applied. Each shaft is heat treated, tempered, induction hardened, furnished with a black anodized finish and covered by our exclusive 10-year warranty.

Dana 60 Front Blank 22" - 4340 Chromoly ⁵	10600	NA	22"	35	D60
Dana 60 Front Blank 39" - 4340 Chromoly ⁵	10601	NA	39"	35	D60
Front Custom Length - 4340 Chromoly	CALL	NA	CUSTOM	CUSTOM	D60
Rear Semi-Float, 35-Spline, Dual Bolt Circle - 4140 Chromoly ⁵	21114	NA	29-1/2"	35	D60
Rear Semi-Float, 35-Spline, Dual Bolt Circle - 4140 Chromoly ⁵	21115	NA	29-1/4"	35	D60
Rear Semi-Float, 35-Spline With 3.5"-Spline, Dual Bolt Circle - 4140 Chromoly ⁵	21214	NA	31-1/2"	35	D60
Rear Semi-Float, 35-Spline With 3.5"-Spline, Dual Bolt Circle- 4140 Chromoly ⁵	21215	NA	31-1/4"	35	D60

⁴ NOTE: Not available at the time of this printing. Will be announced when available.

⁵ NOTE: Upgrade to a 35 spline locker required

Performance Rear Axle Kits

10 TEN YEAR MANUFACTURER WARRANTY



High tensile strength 4340 Chromoly is heat-treated, tempered and induction hardened to produce these heavy-duty axles that are up to 40% stronger than stock 1040 axles. Alloy USA™ uses the latest cold rolled splining technology, to produce splines that are stronger than traditional cut splines. Our shafts are covered by an exclusive 10-year warranty! Rear axle shaft kits include everything you need for your installation: both passenger and drive side shafts, seals, bearings and wheel studs. Upgraded spline counts for Jeep applications: Dana 35 spline upgrades from 27 splines to 30 splines. Dana 44 spline upgrades from 30 splines to 33 and 35 splines.

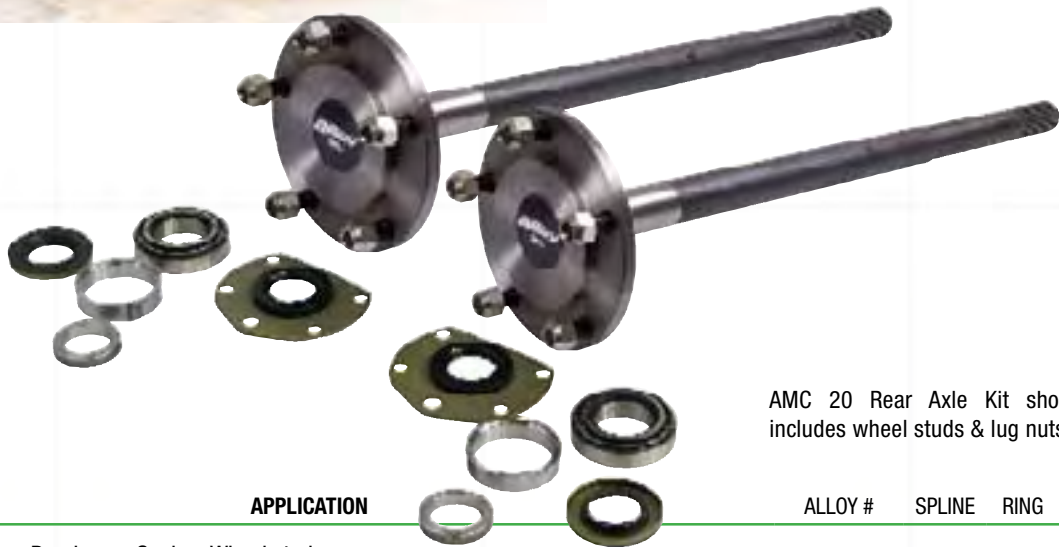

AMC 20 Rear Axle Kit shown includes wheel studs & lug nuts.

APPLICATION	ALLOY #	SPLINE	RING
JEEP® 2 Axles • Bearings • Seals • Wheel studs			
Jeep CJ5 76-83, CJ7 & CJ8 76-81, AMC 20, 1-Piece Conversion, Narrow-Trac, Kit	12125	29	M20
Jeep CJ7 & CJ8 82-86, AMC 20, 1-Piece Conversion, Wide-Trac Kit	12126	29	M20
Jeep CJ7 76-79, AMC 20, 1-Piece Conversion, Quadratrac Kit	12127	29	M20
Jeep Wrangler (YJ) 87-89, Cherokee (XJ) 84-89, Dana 35 Grande 30-Spline Kit, (Non C-clip) ¹	12133	30	D35
Jeep Wrangler (YJ) 87-89, Cherokee (XJ) 84-89, Dana 35 Grande 30-Spline Kit With ARB Locker (Non C-clip)	12133-ARB	30	D35
Jeep Wrangler (YJ) 87-89, Cherokee (XJ) 84-89, Dana 35 Grande 30-Spline Kit With Detroit Locker (Non C-clip)	12133-DET	30	D35
Jeep Wrangler (YJ) 90-95, (TJ) 97-06, Cherokee (XJ) 90-01, Dana 35 Grande 30-Spline Kit, (C-clip, Without ABS) ¹	12134	30	D35
Jeep Wrangler (YJ) 90-95, (TJ) 97-06, Cherokee (XJ) 90-01, Dana 35 Grande 30-Spline Kit With ARB Locker, (C-clip, Without ABS)	12134-ARB	30	D35
Jeep Wrangler (YJ) 90-95, (TJ) 97-06, Cherokee (XJ) 90-01, Dana 35 Grande 30-Spline Kit With Detroit Locker, (C-clip, Without ABS)	12134-DET	30	D35
Jeep Wrangler (YJ) 90-95, (TJ) 97-06, Cherokee (XJ) 90-01, Dana 35 27-Spline Kit, (C-clip, Without ABS) (NEW)	12200	27	D35
Jeep Grand Cherokee (ZJ) 94-98, Dana 35 27-Spline Kit (NEW)	12201	27	D35
Jeep Grand Cherokee (ZJ) 94-98, Dana 44 30-Spline Kit (NEW)	12202	30	D44
Jeep Wrangler (TJ) 97-06, Dana 44 30-Spline Kit	12135	30	D44
Jeep Wrangler (TJ) 97-06, Dana 44 Grande 33-Spline Kit ²	12136	33	D44
Jeep Wrangler (TJ) 97-06, Dana 44 Grande 33-Spline Kit With ARB Locker	12136-ARB	33	D44
Jeep Wrangler (TJ) 97-06, Dana 44 Grande 33-Spline Kit With Detroit Locker	12136-DET	33	D44
Jeep Wrangler (TJ) 97-06, Dana 44 Mas Grande 35-Spline Kit ³	12137	35	D44
Jeep Wrangler (TJ) 97-06, Dana 44 Mas Grande 35-Spline Kit With ARB Locker	12137-ARB	35	D44
Jeep Wrangler (JK) 07-10, Dana 44 Grande 30-Spline Kit (NEW)	12156	30	D44
Jeep Wrangler (JK) 07-10 Rubicon, Dana 44 Grande 32-Spline Kit (NEW)	12158	32	D44

¹ NOTE: Upgrade to 30 spline locker required.

² NOTE: Upgrade to 33 spline locker required.

³ NOTE: Upgrade to 35 spline locker required.

Performance Rear Axle Shafts



**TEN YEAR
MANUFACTURER WARRANTY**



Rule #1: If it broke it needed to be upgraded. For less than the cost of an original replacement axle shaft you can upgrade to an Alloy USA™ performance shaft. Each axle is heat-treated, tempered and induction hardened to have twice the tensile strength than stock and is up to 35% stronger. We use the latest splining technology, to produce splines that are stronger than traditional cut splines.

APPLICATION	ALLOY #	HOLLANDER	SPLINE	LENGTH	SIDE	RING
JEEP® Axle Shafts Sold Individually. Wheel bearings, seals and wheel studs available separately.						
Jeep CJ5 72-75, Dana 44, LH/RH, 30-Spline (NEW)	21147	NA	30	24-3/4"	LH/RH	D44
Jeep CJ5 76-83, CJ7 & CJ8 76-81, AMC 20, 2-Piece OE Style RH, Narrow-Trac (NEW)	21130	NA	29	29"	RH	M20
Jeep CJ5 76-83, CJ7 & CJ8 76-81, AMC 20, 2-Piece OE Style LH, Narrow-Trac (NEW)	21131	NA	29	26-1/4"	LH	M20
Jeep CJ5 76-83, CJ7 & CJ8 76-81, AMC 20, 1-Piece Conversion RH, Narrow-Trac (NEW)	21101	NA	29	26-1/4"	RH	M20
Jeep CJ5 76-83, CJ7 & CJ8 76-81, AMC 20, 1-Piece Conversion LH, Narrow-Trac (NEW)	21100	NA	29	23-1/4"	LH	M20
Jeep CJ7 76-79, AMC 20, 2-Piece OE Style RH, Quadratrac (NEW)	21132	NA	29	22"	RH	M20
Jeep CJ7 76-79, AMC 20, 2-Piece OE Style LH, Quadratrac (NEW)	21133	NA	29	33-1/2"	LH	M20
Jeep CJ7 76-79, AMC 20, 1-Piece Conversion RH, Quadratrac (NEW)	21104	NA	29	19"	RH	M20
Jeep CJ7 76-79, AMC 20, 1-Piece Conversion LH, Quadratrac (NEW)	21105	NA	29	30-7/16"	LH	M20
Jeep CJ7 & CJ8 82-86, AMC 20, 2-Piece OE Style RH, Wide-Trac (NEW)	21134	NA	29	31-9/16"	RH	M20
Jeep CJ7 & CJ8 82-86, AMC 20, 2-Piece OE Style LH, Wide-Trac (NEW)	21135	NA	29	28-9/16"	LH	M20
Jeep CJ7 & CJ8 82-86, AMC 20, 1-Piece Conversion RH, Wide-Trac (NEW)	21103	NA	29	28-7/16"	RH	M20
Jeep CJ7 & CJ8 82-86, AMC 20, 1-Piece Conversion LH, Wide-Trac (NEW)	21102	NA	29	25-1/2"	LH	M20
Jeep Wrangler (YJ) 87-89, Cherokee (XJ) 84-89, Dana 35, RH, 27-Spline w/o ABS (NEW)	21136	1799R	27	28.85"	RH	D35
Jeep Wrangler (YJ) 87-89, Cherokee (XJ) 84-89, Dana 35, LH, 27-Spline w/o ABS (NEW)	21137	1799L	27	30.35"	LH	D35
Jeep Wrangler (YJ) 90-92, Cherokee (XJ) 90-91, Dana 35, RH, 27-Spline w/ ABS (NEW)	21138	NA	27	29.04"	RH	D35
Jeep Wrangler (YJ) 90-92, Cherokee (XJ) 90-91, Dana 35, LH, 27-Spline w/ ABS (NEW)	21139	NA	27	30.54"	LH	D35
Jeep Wrangler (YJ) 90-95, (TJ) 97-06, Cherokee (XJ) Dana 35, RH, 27-Spline w/o ABS (NEW)	21120	1797R	27	29-1/16"	RH	D35
Jeep Wrangler (YJ) 90-95, (TJ) 97-06, Cherokee (XJ) Dana 35, LH, 27-Spline w/o ABS (NEW)	21121	1797L	27	30-9/16"	LH	D35
Jeep Wrangler (YJ) 93-95, (TJ) 97-02, Cherokee (XJ) 92-01 Dana 35, RH, 27-Spline w/ ABS & Drum (NEW)	21140	1832R	27	29"	RH	D35
Jeep Wrangler (YJ) 93-95, (TJ) 97-02, Cherokee (XJ) 92-01 Dana 35, LH, 27-Spline w/ ABS & Drum (NEW)	21141	1832L	27	30-5/8"	LH	D35
Jeep Wrangler (TJ) 03-06, Dana 35, RH, 27-Spline w/ABS & Rear Drum (NEW)	21148	NA	27	29"	RH	D35
Jeep Wrangler (TJ) 03-06, Dana 35, LH, 27-Spline w/ABS & Rear Drum (NEW)	21149	NA	27	29.06"	LH	D35
Jeep Wrangler (TJ) 03-06, Dana 35, RH, 27-Spline w/ABS & Rear Disc (NEW)	21150	NA	27	29"	RH	D35
Jeep Wrangler (TJ) 03-06, Dana 35, LH, 27-Spline w/ABS & Rear Disc (NEW)	21151	NA	27	29.75"	LH	D35
Jeep Wrangler (TJ) 97-06, Dana 44, RH, 30-Spline w/o ABS	21106	2416R	30	29-3/4"	RH	D44
Jeep Wrangler (TJ) 97-06, Dana 44, LH, 30-Spline w/o ABS	21107	2416L	30	29-1/4"	LH	D44
Jeep Wrangler (TJ) 03-06, Dana 44, RH, 30-Spline w/ABS & Rear Drum (NEW)	21142	NA	30	29-3/4"	RH	D44
Jeep Wrangler (TJ) 03-06, Dana 44, LH, 30-Spline w/ABS & Rear Drum (NEW)	21143	NA	30	29-1/4"	LH	D44
Jeep Wrangler (TJ) 03-06, Dana 44, RH, 30-Spline w/ABS & Rear Disc (NEW)	21144	NA	30	29-3/8"	RH	D44
Jeep Wrangler (TJ) 03-06, Dana 44, LH, 30-Spline w/ABS & Rear Disc (NEW)	21145	NA	30	30-1/16"	LH	D44
Jeep Wrangler (JK) 07-10, Dana 44, LH/RH, 30-Spline (NEW)	21204C	NA	30	31.49"	LH/RH	D44
Jeep Wrangler Rubicon (JK) 07-10, Dana 44, LH (NEW)	21205C	NA	32	30.79"	LH	D44
Jeep Wrangler Rubicon (JK) 07-10, Dana 44, RH (NEW)	21206C	NA	32	32.165"	RH	D44
Jeep Cherokee (XJ) 91-96, LH/RH, Chrysler 8.25", 27-Spline	21116	1831	27	29-3/4"	LH/RH	8.25"
Jeep Cherokee (XJ) 97-01, LH/RH, Chrysler 8.25", 29-Spline	21118	2235	29	29-3/4"	LH/RH	8.25"
Jeep Grand Cherokee (ZJ) 94-98, Dana 35, RH, 27-Spline (NEW)	21122	2081R	27	29-1/8"	RH	D35
Jeep Grand Cherokee (ZJ) 94-98, Dana 35, LH, 27-Spline (NEW)	21123	2081L	27	30-9/16"	LH	D35
Jeep Grand Cherokee (ZJ) 94-98, Dana 44, RH, 30-Spline (NEW)	21124	2232R	30	29-1/4"	RH	D44
Jeep Grand Cherokee (ZJ) 94-98, Dana 44, LH, 30-Spline (NEW)	21125	2232L	30	30-1/4"	LH	D44
Jeep Grand Cherokee (WJ) 99-04, Dana 35, RH, 27-Spline (NEW)	21126	2461	27	30-1/4"	RH	D35
Jeep Grand Cherokee (WJ) 99-04, Dana 35, LH, 27-Spline (NEW)	21127	2462	27	31-7/8"	LH	D35
Jeep Grand Cherokee (WJ) 99-04, Dana 44, RH, 30-Spline (NEW)	21128	2703R	30	29-3/8"	RH	D44
Jeep Grand Cherokee (WJ) 99-04, Dana 44, LH, 30-Spline (NEW)	21129	2703L	30	23-3/8"	LH	D44

Performance Rear Axle Kits

10 TEN YEAR
MANUFACTURER WARRANTY



Why do you need Alloy axle shafts? Because horsepower is useless if can't get it to the ground. Our performance rear axle kits feature 1541H alloy steel and have been propelling cars to victory for nearly a decade. 1541H is a high carbon steel that contains significantly more manganese than 1040 steel found in your stock axles. This increases ductility and translates the ability to absorb stresses. Our heat-treated and induction hardened shafts have twice the tensile strength than stock and are up to 35% stronger. We use the latest cold spline rolling technology to produce splines that are stronger than traditional cut splines. No cuts means no edges, which create stress points and can lead to fracturing. The shafts are then precision CNC machined and magnaflux inspected for cracks before receiving a slick black anodized or natural finish. Our rear axle shaft kits include everything you need for your installation: both passenger and drive side shafts, seals, bearings and wheel studs.



APPLICATION	ALLOY #	SPLINE	RING
FORD 2 Axles • Bearings • Seals • Wheel studs			
Ford Mustang 5-Lug 79-93, 8.8", 28-Spline Kit	12180	28	8.8"
Ford Mustang 5-Lug 79-93, 8.8", 31-Spline Kit ⁴	12181	31	8.8"
Ford Mustang 4-Lug 79-93, 8.8", 28-Spline Kit	12182	28	8.8"
Ford Mustang 4-Lug 79-93, 8.8", 31-Spline Kit ⁴	12183	31	8.8"
Ford Mustang 94-98, 8.8", 28-Spline Kit	12184	28	8.8"
Ford Mustang 94-98, 8.8", 31-Spline Kit ⁴	12185	31	8.8"
Ford Mustang 99-04, 8.8", 28-Spline Kit	12186	28	8.8"
Ford Mustang 99-04, 8.8", 31-Spline Kit ⁴	12187	31	8.8"
Ford Mustang 05-09, 8.8", 31-Spline Kit (NEW)	12189	31	8.8"
Ford Explorer 95-00, 8.8", Grande 31-Spline Kit, 4140 Chromoly (NEW)	12188	31	8.8"
GM 2 Axles • Bearings • Seals • Wheel studs			
Chevrolet Chevelle 65-67, Camaro 67-69, Nova 70-75, 8.2" & 8.5", 28-Spline Kit	12100	28	8.2"
Chevrolet Chevelle 68-72, Camaro 70-81 LH/RH, 8.2" & 8.5", 28-Spline Kit	12101	28	8.2"
Chevrolet Chevelle 73-77, 8.5", 28-Spline Kit	12102	28	8.5"
Chevrolet Chevelle 68-72, Camaro 70-81, 8.875", 30-Spline Kit	12109	30	8.875"
Chevrolet Chevelle 65-67, Camaro 67-69, 8.875", 30-Spline Kit	12110	30	8.875"
Chevrolet Camaro 90-92, 7.625", 28-Spline Kit	12103	28	7.625"
Chevrolet Camaro 93-96, 7.625", 28-Spline Kit	12104	28	7.625"

⁴ NOTE: Upgrade to 31 spline locker required.



Performance Rear Axle Shafts



TEN YEAR
MANUFACTURER WARRANTY **10**

Axle shafts sold individually. Wheel bearings, seals and wheel studs available separately.

Don't just replace your axle shafts, upgrade them. For less than the cost of an original replacement axle shaft you can upgrade to an Alloy USA™ performance shaft. Our axles are made from 1541H or 4140 steel depending on the application. Each axle is heat-treated and induction hardened to have twice the tensile strength than stock and is up to 35% stronger. We use the latest cold spline rolling technology to produce splines that are stronger than traditional cut splines. No cuts means no edges which create stress points and can lead to fracturing. Each shaft is backed by our exclusive 10-year warranty.

APPLICATION	ALLOY #	OE PART #	HOLLANDER	SPLINE	LENGTH	SIDE	RING
FORD Axle Shafts Sold Individually. Wheel bearings, seals and wheel studs available separately.							
Ford Mustang 79-93 5-lug LH/RH; Ford Ranger 83-92 LH, 8.8" 28-Spline	15110	E3TZ4234C	1338	1338	28	29-1/16"	LH/RH 8.8"
Ford Mustang 4 Lug 79-93 LH/RH, 8.8", 28-Spline	15116	D9BZ4234AC	1231	1231	28	29"	LH/RH 8.8"
Ford Mustang 94-98 LH/RH, 8.8", 28-Spline	15117	F4ZZ4234B	2006	2006	28	29-15/16"	LH/RH 8.8"
Ford Mustang 99-04 LH/RH, 8.8", 28-Spline	15154	XR3Z4234AA	2425	2425	28	30-5/8"	LH/RH 8.8"
Ford Mustang, 99-04 LH/RH, 8.8-Inch, 31-Spline (NEW) ⁴	15136	M-4235-E	-	-	31	30-5/8"	LH/RH 8.8"
Ford Mustang, 94-98 LH/RH, 8.8-Inch, 31-Spline (NEW) ⁴	15137	M-4235-D	-	-	31	29-15/16"	LH/RH 8.8"
Ford Mustang, 5 Lug 79-93 LH/RH, 8.8-Inch, 31-Spline (NEW) ⁴	15138	M-4235-F	-	-	31	29-1/16"	LH/RH 8.8"
Ford Mustang, 4 Lug 79-93 LH/RH, 8.8-Inch, 31-Spline (NEW) ⁴	15142	M-4235-B	-	-	31	29-1/6"	LH/RH 8.8"
Ford Mustang 66-70, Mercury Cougar 67-70 LH 9" 31-Spline (NEW)	15150	C90Z4234C	973L	973L	31	27.12"	LH 9"
Ford Mustang 66-70, Mercury Cougar 67-70 RH 9" 31-Spline (NEW)	15151	C90Z4234D	973R	973R	31	31-1/4"	RH 9"
Ford Mustang 05-09 LH, 8.8", 31-Spline (NEW)	15156	5R3Z4234B	-	-	31	31-11/16"	LH 8.8"
Ford Mustang 05-09 RH, 8.8", 31-Spline (NEW)	15155	5R3Z4234A	-	-	31	32-13/16"	RH 8.8"
Ford Crown Victoria 91-97, Mercury Marquis 92-97 w/ ABS LH/RH (NEW)	15159	F2AZ4234B	1823	1823	28	31-3/4"	LH/RH 8.8"
Ford Crown Victoria 98-02, Mercury Marquis 98-02 LH/RH (NEW)	15160	F8AZ4234B	2307	2307	28	32-7/16"	LH/RH 7.5"/8.8"
Ford F150, Bronco 83-86 RH, 8.8", 31-Spline	15100	E3TZ4264D	1340	1340	31	31-1/16" ¹	RH 8.8"
Ford F150, Bronco 83-86 LH, 8.8", 31-Spline	15101	E3TZ4234E	1341	1341	31	31-3/16"	LH 8.8"
Ford F150, E150 74-86, Rear LH/RH, 9", 31-Spline	15102	D6TZ4234A	1172	1172	31	31-27/32"	LH/RH 9"
Ford F150, E150, Bronco 87-96 RH, 8.8", 31-Spline	15103	E7TZ4234A	1573	1573	31	31-1/16"	RH 8.8"
Ford F150, Bronco 87-96 LH, 8.8", 31-Spline	15104	E7TZ4234B	1574	1574	31	33-3/16"	LH 8.8"
Ford E150 87-96 RH, 8.8", 31-Spline	15107	E7UZ4234E	1575	1575	31	35-5/8"	RH 8.8"
Ford F150, Expedition 97-04, RH, 8.8", 31-Spline	15105	F75Z4234AA	2192	2192	31	31-3/4"	RH 8.8"
Ford F150, Expedition 97-04, LH, 8.8", 31-Spline	15106	F75Z4234AB	2193	2193	31	33-3/8"	LH 8.8"
Ford F150, 97-04 LH, 9.75", 34-Spline	15143	F75Z4234MB	2239	2239	34	33.37"	LH 9.75"
Ford F150, 97-04 RH, 9.75", 34-Spline	15144	F75Z4234MA	2238	2238	34	31-3/4"	RH 9.75"
Ford F250, 86-97 RH Semi Float, 10.25", 35-Spline	15134	E6TZ4234B	1506	1506	35	30.56"	RH 10.25"
Ford F250, 86-97 LH Semi Float, 10.25", 35-Spline	15135	E6TZ4234C	1507	1507	35	33"	LH 10.25"
Ford Ranger 93-97 RH, 8.8", 28-Spline	15139	F37Z4234A	2080R	2080R	28	27-1/4"	RH 8.8"
Ford Ranger 83-92 RH, 7.5", 28-Spline	15108	E3TZ4234B	1337	1337	28	26-1/4"	RH 7.5"/8.8"
Ford Ranger 99-01 RH, 7.5" / 8.8", 28-Spline	15157	F87Z4234AC	24A	24A	28	27-1/4"	RH 7.5"/8.8"
Ford Ranger 99-01 LH, 7.5" / 8.8", 28-Spline	15158	F87Z4234AD	2420	2420	28	30-1/4"	LH 7.5"/8.8"
Ford Explorer 95-00 RH, 8.8" 31-Spline	15114	F5TZ4234A	2120	2120	31	27.62"	RH 8.8"
Ford Explorer 95-00 LH, 8.8" 31-Spline	15115	F5TZ4234B	2121	2121	31	30-1/2"	LH 8.8"
Ford Expedition, Lincoln Navigator 97-02 RH, 9.75", 34-Spline	15146	F75Z4234LA	2236	2236	34	31-1/4"	RH 9.75"
Ford Expedition, Lincoln Navigator 97-02 LH, 9.75", 34-Spline	15145	F75Z4234LB	2237	2237	34	33.37"	LH 9.75"
Ford Aerostar, 86-97 LH, 7.5", 28-Spline	15111	E69Z4234A	1456	1456	28	32-1/4"	LH 7.5"/8.8"

⁴ NOTE: Upgrade to 31 spline locker required.

Performance Rear Axle Shafts Continued

10 TEN YEAR
MANUFACTURER WARRANTY



Induction Hardened & Heat Treated

Cold Rolled Splines



Up to 35% Stronger Than Stock

Black Anodized or Natural Finish

APPLICATION	ALLOY #	OE PART #	HOLLANDER	SPLINE	LENGTH	SIDE	RING
DODGE Axle Shafts Sold Individually. Wheel bearings, seals and wheel studs available separately.							
Dodge Truck/Ramcharger 4WD 74-79, Truck/Ramcharger 2WD 75-83 LH/RH, 9.25", 31-Spline	19100	3723824	1081	31	31-1/16"	LH/RH	9.25"
Dodge Truck/Ramcharger 4WD 84-93 LH/RH, 9.25", 31-Spline (After 4/1/84)	19101	4137429	1398	31	31-5/8"	LH/RH	9.25"
Dodge Truck/Ramcharger 4WD 80-84 LH/RH, 9.25", 31-Spline (Until 3/31/84)	19102	4037726	1289	31	31-5/8"	LH/RH	9.25"
Dodge 1/2-Ton Pickup 94-00 LH/RH, 9.25", 31-Spline	19111	52067614	2030	31	34"	LH/RH	9.25"
GM Axle Shafts Sold Individually. Wheel bearings, seals and wheel studs available separately.							
Pontiac GTO, Firebird 66-69 LH/RH, 8.2", 28-Spline	17131	-	-	28	30"	LH/RH	8.2"
Chevrolet Chevelle 68-72, Camaro 70-72 LH/RH, 8.875", 30-Spline	17119	3969285	1000	30	30-1/16"	LH/RH	8.875"
Chevrolet Chevelle 65-67, Camaro 67-69, Chevy II 68-72 LH/RH, 8.875", 30-Spline	17120	3969349	1005	30	29-9/16"	LH/RH	8.875"
Chevrolet Chevelle 65-67, Camaro 67-69, Nova 70-75 LH/RH, 8.2" & 8.5", 28-Spline	17121	1255803	1010	28	29-5/8"	LH/RH	8.2/8.5"
Chevrolet Chevelle 68-72, Camaro 70-81 LH/RH, 8.2" & 8.5", 28-Spline	17122	1255802	1015	28	30-1/8"	LH/RH	8.2/8.5"
Chevrolet Chevelle 73-77 LH/RH, 8.5", 28-Spline	17123	1255801	1067	28	29-9/16"	LH/RH	8.5"
Chevrolet Camaro 90-92 LH/RH, 7.625", 28-Spline	17126	26031252	1776	28	30-5/8"	LH/RH	7.625"
Chevrolet Camaro 93-96 LH/RH, 7.625", 28-Spline	17127	26027558	1960	28	32"	LH/RH	7.6"
Chevrolet Camaro 98-02 (With Traction Control) LH/RH, 7.625", 28-Spline	17136	26059972	2342	28	32"	LH/RH	7.625"
GM 91-96 LH/RH, Caprice w/Disc Brakes 91-96, Cadillac RWD 91-92, Buick 91-96	17141	26018080	1858	30	30-3/8"	LH/RH	8.5"
GM 1/2 Ton Pickup 65-69 LH/RH, 8.875", 30-Spline	17133	3893605	780	30	20-1/2"	LH/RH	8.875"
GM Blazer, Jimmy, Suburban, 1/2 Ton Pickup 70-81 LH/RH, 8.875", 30-Spline	17103	14071750	1063	30	31-9/32"	LH/RH	8.875"
GM Blazer, Suburban, 1/2 Pickup 70-81 LH/RH, 8.875", 2WD, 30-Spline	17109	14071751	1062	30	31-5/16"	LH/RH	8.875"
GM Blazer, C10, C1500, Jimmy, Suburban, 1/2 Pickup 79-89 LH/RH, 8.5" 28-Spline	17112	14035542	1204	28	31.38"	LH/RH	8.5"
GM Blazer, Jimmy, Suburban, 1/2 Ton Pickup 81-88 LH/RH, 8.5", 28-Spline	17104	14039547	1300	28	31-5/16"	LH/RH	8.5"
GM Suburban (3/4 & 1 Ton), Van (3/4 & 1 Ton) 81-96 LH/RH, 9.5", 33-Spline	17140	14035395	1276	33	32-9/16"	LH/RH	9.5"
GM 1/2 Ton Pickup 88-00; Suburban, Tahoe, Yukon 92-98 LH/RH, 8.5", 4WD w/IFS, 30-Spline	17137	26010416	1671	30	33"	LH/RH	8.5"
GM Blazer, Jimmy, Suburban, 1/2 Ton Pickup 88-91 LH/RH, 8.5", 30-Spline	17105	26010414	1652	30	31-5/16"	LH/RH	8.5"
GM Suburban, 1/2 Ton Pickup, 3/4 Ton Pickup 88-99 LH/RH, 9.5", 6 Lug, 33-Spline	17106	15521928	1610	33	33.13"	LH/RH	9.5"
GM Suburban (1/2 Ton), Blazer 88-91h/rh, 8.5", 30-Spline	17113	26010415	1669	30	31-3/4"	LH/RH	8.5"
GM 1500 Series 88-98; 1/2 Pickup 88-00; Suburban 92-98; Tahoe, Yukon 94-98 LH/RH, 8.5"	17110	26010417	1670	30	31-13/16"	LH/RH	8.5"
GM 1500 Series 92-98, 2500 Series 88-98, 3500 Series 88-89, 3/4 Ton 88-89 LH/RH, 9.5", 8-lug	17118	15522070	1615	33	31-13/16"	LH/RH	9.5"
GM Silverado, Sierra 99-01 With Disc Brakes LH/RH, 8.5", 30-Spline	17129	12471369	2457	30	30-5/8"	LH/RH	8.5"
GM S10, S15, SM, Blazer, Jimmy, Sonoma 83-89 LH/RH, 7.5", 4WD, 26-Spline	17108	14035368	1329	26	29"	LH/RH	7.6"
GM S10 88-94 LH/RH, 7.5", 2WD, 28-Spline	17125	26015759	1599	28	26-5/8"	LH/RH	7.5"
GM S10, S15, SM, Blazer, Jimmy, Sonoma 90-98 LH/RH, 7.5" & 7.625", 4WD, 28-Spline	17107	26013882	1651	28	29"	LH/RH	7.5"
GM 1/2 Ton Van 75-88 LH/RH, 8.5", 28-Spline	17139	14042690	1085	28	33-5/16"	LH/RH	8.5"
GM 1/2 Ton Van 88-95 LH/RH, 8.5", 30-Spline	17138	26013313	1672	30	33-5/16"	LH/RH	8.5"
GM Astro Van 90-98 LH, 7.5", 28-Spline	17116	26011054	1765	28	34-13/16"	LH	7.5"
GM Astro Van 90-98 RH, 7.5", 28-Spline	17117	26011055	1764	28	30-1/16"	RH	7.5"
INTERNATIONAL Axle Shafts Sold Individually. Wheel bearings, seals and wheel studs available separately.							
International Scout 71-80 LH/RH, Dana 44	21117C	706162-2X	-	30	28-1/4"	LH/RH	D44



**FIVE YEAR
MANUFACTURER WARRANTY**



Jeep® Ring & Pinions

These affordable high strength gear sets come in all the popular ratios to satisfy everyone's gearing needs. Oversized tires require higher ring & pinion ratios to restore performance. Made from high quality 8620 forgings and Gleason gear cutting technology, these gears are made to last. Complete installation kits are available separately to complete the job. Exclusive 5-year warranty. Available in 3.73, 4.10, 4.56, 4.88 and 5.13 ratios.

APPLICATION	RATIO	ALLOY #
FRONT		
CJ5, CJ7, CJ8, 72-86, Dana 30 Front, 3.73 Ratio	3.73	D30373
CJ5, CJ7, CJ8, 72-86, Dana 30 Front, 4.10 Ratio	4.10	D30410
CJ5, CJ7, CJ8, 72-86, Dana Front 30, 4.56 Ratio	4.56	D30456
CJ5, CJ7, CJ8, 72-86, Dana 30 Front 4.88 Ratio	4.88	D30488
Wrangler (YJ) 87-95, Cherokee (XJ) 84-91, Dana 30 Reverse, 3.73 Ratio	3.73	D30373R
Wrangler (YJ) 87-95 Cherokee (XJ) 84-91, Dana 30 Reverse, 4.10 Ratio	4.10	D30410R
Wrangler (YJ) 87-95, Cherokee (XJ) 84-91, Dana 30 Reverse, 4.56 Ratio	4.56	D30456R
Wrangler (YJ) 87-95, Cherokee (XJ) 84-91, Dana 30 Reverse, 4.88 Ratio	4.88	D30488R
Wrangler (TJ) 97-06, Front Dana 30, 3.73 Ratio (Short)	3.73	D30373TJ
Wrangler (TJ) 97-06 Front Dana 30, 4.10 Ratio (Short)	4.10	D30410TJ
Wrangler (TJ) 97-06, Cherokee (XJ) 92-01, Dana 30, 4.56 Ratio (Short)	4.56	D30456TJ
Wrangler (TJ) 97-06, Cherokee (XJ) 92-01, Dana 30 4.88 Ratio (Short)	4.88	D30488TJ
Wrangler (TJ) Rubicon 03-06, Front/Rear Dana 44, 4.88 Ratio	4.88	D44488X
Wrangler (TJ) Rubicon 03-06, Front/Rear Dana 44, 5.13 Ratio	5.13	D44513X
Wrangler (JK) 07-10, Front Dana 30, 4.10, Ratio (NEW)	4.10	D30410RJK
Wrangler (JK) 07-10, Front Dana 30, 4.88 Ratio (NEW)	4.88	D30488RJK
Wrangler (JK) 07-10, Front Dana 30, 5.13 Ratio (NEW)	5.13	D30513RJK
Wrangler (JK) 07-10, Front Dana 44, 4.88 Ratio (NEW)	4.88	D44488RJK
Wrangler (JK) 07-10, Front Dana 44, 5.13 Ratio (NEW)	5.13	D44513RJK

APPLICATION	RATIO	ALLOY #
REAR		
CJ5, CJ7, CJ8, 76-86, AMC 20, 3.73 Ratio	3.73	AMC373
CJ5, CJ7, CJ8, 76-86, AMC 20, 4.10 Ratio	4.10	AMC410
CJ5, CJ7, CJ8, 76-86, AMC 20, 4.56 Ratio	4.56	AMC456
CJ5, CJ7, CJ8, 76-86, AMC 20, 4.88 Ratio	4.88	AMC488
Wrangler (YJ, TJ) 87-06, Cherokee (XJ) 84-01, Dana 35 Rear, 3.73 Ratio	3.73	D35373
Wrangler (YJ, TJ) 87-06, Cherokee (XJ) 84-01, Dana 35 Rear, 4.10 Ratio	4.10	D35410
Wrangler (YJ,TJ) 87-06, Cherokee (XJ) 84-01, Dana 35 Rear, 4.56 Ratio	4.56	D35456
Wrangler (YJ,TJ) 87-06, Cherokee (XJ) 84-01, Dana 35, 4.88 Ratio	4.88	D35488
Wrangler (TJ) 97-06, Rear Dana 44, 3.73 Ratio	3.73	D44373
Wrangler (TJ) 97-06, Rear Dana 44, 4.10 Ratio	4.10	D44410
Wrangler (TJ) 97-06, Rear Dana 44, 4.56 Ratio	4.56	D44456
Wrangler (TJ) 97-06, Rear Dana 44, 4.88 Ratio	4.88	D44488
Wrangler (TJ) 97-06, Rear Dana 44, 5.13 Ratio	5.13	D44513
Wrangler (TJ) Rubicon 03-06, Front/Rear Dana 44, 4.88 Ratio	4.88	D44488X
Wrangler (TJ) Rubicon 03-06, Front/Rear Dana 44, 5.13 Ratio	5.13	D44513X
Wrangler (JK) 07-10, Rear 7/16 Bolts, Dana 44, 4.10 Ratio (NEW)	4.10	D44410JK
Wrangler (JK) 07-10, Rear Dana 44, 4.88 Ratio (NEW)	4.88	D44488JK
Wrangler (JK) 07-10, Rear Dana 44, 5.13 Ratio (NEW)	5.13	D44513JK
Cherokee (XJ) 91-01, Chrysler 8.25", 3.55 Ratio (NEW)	3.55	C83355

APPLICATION	RATIO
Carrier Break	
Dana 30	3:54 & lower
Dana 30	3:73 & higher
Dana 35	3:31 & lower
Dana 35	3:55 & higher
Dana 44	3:73 & lower
Dana 44	3:92 & higher



Ring & Pinion Master Installation & Overhaul Kits For Jeep®



These great kits offer all the components you will need to complete your differential rebuild or ring & pinion installation. Complete with bearings, pinion seals, pinion shims, crush sleeve, pinion nut, ring gear bolts and marking compound.

APPLICATION	ALLOY #
CJ5, CJ7, CJ8, 72-86, AMC Model 20	352025
CJ5, CJ7, CJ8 72-86, Dana 30, Front (NEW)	352065
CJ5, CJ7, 72-75, Dana 44 Rear	352033
Wrangler (YJ) 87-95, Cherokee (XJ) 84-91, Dana 30 Front	352032
Wrangler (YJ, TJ) 87-06, Cherokee (XJ) 84-01, Dana 35 Rear	352049
Wrangler (TJ) 97-06, Cherokee (XJ) 92-01, Dana 30 Front	352031
Wrangler (TJ) 97-06, Dana 44 Rear	352033
Wrangler (TJ) Rubicon 03-06, Dana 44 Front/Rear	352045
Wrangler (JK) 07-10, Dana 30, Front (NEW)	352050
Wrangler (JK) 07-10, Dana 44, Front (NEW)	352051
Wrangler Rubicon (JK) 07-10, Dana 44, Rear (NEW)	352052
Wrangler X, Sahara (JK) 07-10, Dana 44, Rear (NEW)	352053
Grand Cherokee (WJ) 99-04, Dana 35, Rear (NEW)	352061
Grand Cherokee (WJ) 99-00, Before 3/29/00, Dana 44, Rear (NEW)	352062
Grand Cherokee (WJ) 00-04, After 3/29/00, Dana 44, Rear (NEW)	352063
Cherokee (XJ) 91-01, Chrysler 8.25, Rear (NEW)	352064

Yoke Conversion Kits

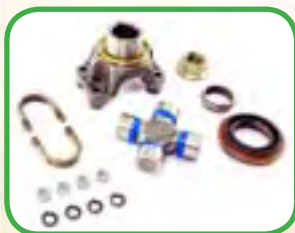

NEW YOKE CONVERSION KITS - Converts Strap To U-Bolt Design, Includes Spicer U-Joint And U-Bolts	ALLOY #
CJ5 76-81, CJ7, CJ8 76-86, AMC 20 (NEW)	380003
CJ5, CJ7, CJ8, 72-86, Wrangler (YJ, TJ) 87-06, Cherokee (XJ) 84-01, Dana 30 (NEW)	380001
Wrangler (YJ) 87-93, Wrangler (TJ) 97-02, Cherokee (XJ) 84-95, Dana 35 (NEW)	380002

Wheel Spacers



**THREE YEAR
MANUFACTURER WARRANTY**

NEW!

- Moves your wheels out to help fit wider tires-creates extra stability.
- Hub centric design to assure wheel balance.
- Constructed of durable 6061T6 aluminum for long life, extra strength and corrosion resistance.
- Available in 1.25" to 1.5" widths for today's most popular wheel sizes.
- Each pair includes pre-installed grade 8 wheel studs, 10 lug nuts and thread locker.
- Wheel adaptors convert current bolt patterns to alternate bolt patterns for use with different wheels.
- Wheel Spacers and Wheel adaptors are sold in pairs.



**COMING
SOON!**

Wheel Spacers

Vehicle Application	Width	Bolt Pattern	Part #
Jeep Wrangler 2007-2010 (NEW)	1.5"	5 on 5"	11300
Jeep Wrangler 1987-2006 (NEW)	1.25"	5 on 4.5"	11301
Jeep Cherokee 1984-2001 (NEW)	1.25"	5 on 4.5"	11301
Jeep CJ 1945-1986 (NEW)	1.25"	5 on 5.5"	11302

Wheel Adaptors

Vehicle Application	Width	Conversion	Part #
Jeep Wrangler 1987-2006 (NEW)	1.25"	5 on 5" to 5 on 4.5"	11310
Jeep Cherokee 1984-2001 (NEW)	1.25"	5 on 5" to 5 on 4.5"	11310

Alloy X-Joint

Cold Forged • Serviceable

APPLICATION

ALLOY #

Heavy Duty Alloy X-joint, Complete U-joint With Bearings (760 Style)

11500

Replaces 5-297X/5-760X

Now a serviceable U-joint for Dana 44 applications is available to you. Replace your 760X U-joint with Alloy USA's new X-joint!



Alloy Axle Tube Seals

Keep water, mud and debris from entering your front axle housing. These CNC machined aluminum housings feature two seals to provide double protection from the crud.



NEW!

APPLICATION

JK

ALLOY #

2007-10 Wrangler (JK) Dana 30 or 44 front axle 1984-06 Wrangler (YJ,TJ) Cherokee (XJ) Grand Cherokee (ZJ) (2) (NEW)

11105 (RED)
11106 (BLACK)

1984-06 Wrangler (YJ,TJ) Cherokee (XJ) Grand Cherokee (ZJ) Dana 30 (1)

11102 (RED)
11103 (BLACK)

(1) Note: Will not fit 87-95 Wranglers with O.E. front disconnect axle. Must upgrade to one piece axle. Will not fit Grande 30 spine axles. For 27 Spline applications only.

(2) Note: Will not fit 87-95 Wranglers with O.E. front disconnect axle. Must upgrade to 1 pc 30 spline grand axle. For use with all grande 30 spline axle upgrades & Rubicon Dana 44's.

Alloy HD Differential Covers

Indestructible! You won't break these covers, we guarantee it. Made from either 3/8" cast steel or 5/16" stamped steel, painted black inside and out, these heavy-duty covers are designed to protect your differential and all its working parts for as long as you own your vehicle. These indestructible covers have been ".44 caliber tested" - if they can take a bullet at point blank range (don't try this at home!), they can take all that the trail has to offer. Available for most popular Dana differential types and include extra reinforcement protection for the fill plug area. All mounting hardware and instructions are included for ease of installation.

Cast Differential Covers

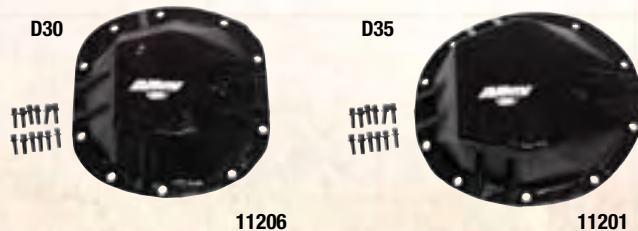

Stamped Differential Covers

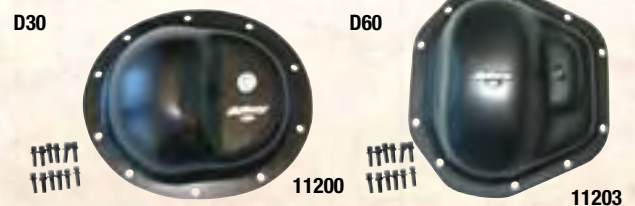

APPLICATION

CAST
3/8"
STEEL

STAMPED
5/16"
STEEL

HD Dana 30 Differential Cover (NEW)

11206

11200

HD Dana 35 Differential Cover (NEW)

11201

-

HD Dana 44 Differential Cover (NEW)

11202

-

HD Dana 60 Differential Cover (NEW)

11207

11203

HD AMC 20 Differential Cover (NEW)

11205

-

AXLE UPGRADES



PSL400



PSL450



PSL1100



PSL750



PSL900



PSL1000

Part

Dodge 1500-3500 Series. All with Dana 44 or Dana 60 with central disconnect	PSL400
Dodge 1985-93 1/2 or 3/4 Ton. All with central disconnect	PSL450
GM 1983-99 S/T 10-15, Blazer, Jimmy, All with vacuum actuators	PSL500
GM 1988-98 K1500, K2500 (6-LUG), 4WD Suburban, All w/thermal linear actuator	PSL600
GM 1988-99 K2500, K3500 (8-LUG), 1992-99 Suburban, All w/thermal linear actuator	PSL800
Ford 1997-2003 F150. This kit replaces factory vacuum unit	PSL750
1987-95 DANA-30, YJ, XJ Jeeps®	PSL900
1987-95 DANA-30 YJ, XJ Jeeps® with 3" to 6" lift	PSL920
XJ, YJ POSI LOCK cast iron shift fork, front D30 with disconnect	PSL100
GM/Chevy PSL600 & PSL800. Fits 1988-98 1500 & 2500 6-Lug 1992-98 Suburban,	
Tahoe & Yukon 6-Lug, & 1988-98 2500 & 3500 8-Lug 1992-98 Suburban 8-Lug	PSL1000
1984-91 XJ, 1987-95 YJ, 1994-01 DODGE RAM	PSL1100



PSL100

YOU PAID THOUSANDS OF DOLLARS FOR YOUR 4-WHEEL DRIVE! SHOULDN'T IT WORK WHEN YOU NEED IT? WHETHER YOU USE YOUR 4-WHEEL DRIVE ONCE A YEAR OR DAILY, 4X4 POSI-LOK IS THE ONLY SURE THING.

- A permanent replacement for the failure prone O.E. vacuum and electric front axle engagement systems.
- Allows you to engage the front axle from inside the cab.
- Engagement every time because you are in direct control.
- A 1" pull of the cable ensures you will have 4-wheel drive when you need it, as long as the transfer case is engaged.
- It is not a posi-trac or locker.
- Simple and easy to install.
- A patented front axle engagement system

4X4 POSI-LOK IS A CABLE OPERATED AXLE ENGAGEMENT SYSTEM TO REPLACE THE FAILURE PRONE VACUUM C.A.D. SYSTEM. IT ALSO ALLOWS THE USE OF 2 WHEEL (REAR) LOW RANGE AND A FRONT LOCKER.

Ring & Pinion

Install Kit Includes:

- Carrier Bearings
- Pinion Bearings
- Pinion Nut
- Pinion Seal
- Preload Shims or Crush Collar
- Pinion Shims
- Gasket or RTV
- Marking Compound
- Differential Shims (where applicable)
- Locktite
- Oil Slingers (where applicable)
- Ring Gear Bolts (where applicable)

Master Installation Kits: Precision Gear understands the complexity of rebuilding your differential. To help solve this difficulty and eliminate multiple trips to the parts store we have including everything you need to complete you ring & pinion installation and get you back on the road quick all in one great kit. Master installation kits include:

**FIVE YEAR
MANUFACTURER WARRANTY**

5



AMC 20

Ratio	Part #
3.08	AMC/308
3.54	AMC/354
3.73	AMC/373
4.10	AMC/410
4.56	AMC/456
Master Installation Kit	352025

Dana 30

Ratio	Part #
3.07	30D/307
3.54	30D/354
3.73	30D/373
3.91	30D/391
4.10	30D/410
4.56	30D/456
Master Installation Kit	352032

Dana 44

Ratio	Part #
3.23	44D/323
3.31	44D/331
3.42	44D/342
3.54	44D/354
3.73	44D/373
4.09	44D/409
4.27	44D/427
4.56	44D/456
4.88	44D/488
5.13	44D/513
Master Installation Kit	352033

Ford 8.8"

Ratio	Part #
3.55	F88/355
3.73	F88/373
4.10	F88/410
4.30	F88/430
4.56	F88/456
4.88	F88/488
Master Installation Kit	352013

* Ring & Pinions and Installation Kits are sold separately.



Dana 35

Ratio	Part #
3.55	35D/355
3.73	35D/373
4.10	35D/410
4.56	35D/456
4.88	35D/488
Master Installation Kit	352049

Dana 44 Reverse

Ratio	Part #
3.07	44D/307R
3.50	44D/350R
3.54	44D/354R
3.73	44D/373R
4.09	44D/409R
4.56	44D/456R
4.88	44D/488R
5.13	44D/513R
Master Installation Kit	352033A

Ford 9"

Ratio	Part #
3.08	F9/308
3.25	F9/325
3.50	F9/350
3.70	F9/370
3.89	F9/389
4.11	F9/411
4.30	F9/430
4.57	F9/457

1982- Master Installation Kit 352011
1983+ Master Installation Kit 352011A

Dana 35 Reverse

Ratio	Part #
4.56	35D/456R
4.88	35D/488R
5.13	35D/513R
Master Installation Kit	352049A

Dana 60

Ratio	Part #
3.54	60D/354
3.73	60D/373
4.10	60D/410
4.56	60D/456
4.88	60D/488
5.13	60D/513
Master Installation Kit	352034

Ford 10.25" (1985-92)

Ratio	Part #
3.55	F10/355S
3.73	F10/373E
4.10	F10/410S
4.56	F10/456S
Master Installation Kit	352046

Precision Gear Ring and Pinions: Precision Gear understands the rigors of racing. Horsepower is useless unless you can get it to the ground. Most companies providing ring and pinions today look for the cheapest source without consideration of quality. They “stand behind” their product until the day you buy it and install it on your car. -At Precision Gear each ring and pinion we sell is backed by an exclusive five year warranty! Our gears are made from high quality 8620 forgings and Gleason gear cutting technology because are gears are made to last!



For additional product listings and more information visit www.precisiongear.com.

Ford 10.25 (1993-98)

Ratio	Part #
3.55	F10/355L
3.73	F10/373L
4.10	F10/410L
4.56	F10/456L
4.88	F10/488L
5.13	F10/513L
Master Installation Kit	352046

GM 9.25"

Ratio	Part #
4.10	GM9F/410
4.56	GM9F/456
4.88	GM9F/488
5.13	GM9F/513
Master Installation Kit	352096

Toyota 7.5" Tacoma

Ratio	Part #
4.56	TAC/456R
4.88	TAC/488R
5.29	TAC/529R
Master Installation Kit	352056

Toyota 8" V6/Turbo

Ratio	Part #
4.11	TOY/411T
4.56	TOY/456T
4.88	TOY/488T
5.29	TOY/529T
Master Installation Kit	352043

GM 8.5"

Ratio	Part #
3.08	GM10/308
3.42	GM10/342
3.73	GM10/373
3.90	GM10/390
4.10	GM10/410
4.56	GM10/456
4.88	GM10/488
Master Installation Kit	352021

GM 8-7/8"

Ratio	Part #
3.08	GM12/308
3.42	GM12/342
3.73	GM12/373
4.10	GM12/410
4.56	GM12/456
4.88	GM12/488
Master Installation Kit	352018

GM 9.5"

Ratio	Part #
3.42	GM9/342
3.73	GM9/373
4.10	GM9/410
4.56	GM9/456
4.88	GM9/488
5.13	GM9/513
Master Installation Kit	352010

GM 10.5

Ratio	Part #
3.73	GM14/373
4.10	GM14/410
4.56	GM14/456
4.56+	GM14/456+
4.88+	GM14/488+
5.13+	GM14/513+
1987- Master Installation Kit	352023
1988+ Master Installation Kit	352023A

Toyota 8" Tacoma

Ratio	Part #
4.56	TAC/456
4.88	TAC/488
5.29	TAC/529
Master Installation Kit	352055

Toyota 8" 200mm

Ratio	Part #
3.54	TOY/354
4.11	TOY/411
4.56	TOY/456
4.88	TOY/488
5.29	TOY/529
Master Installation Kit	352041



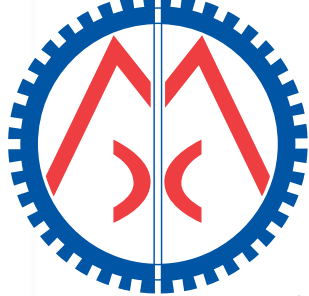

OMIX-ADA®

The following 111 pages contain all the parts you need for restoring/repairing your Jeep®! From 1941 to current, Omix has you covered. If you know Jeep, you know Omix!



AUTHENTIC RESTORATION PRODUCT

This emblem is Mopar's "Seal Of Approval" that the product meets their standards and is truly a licensed product. Parts identified with the Mopar Authentic Restoration Product emblem are the only parts in this catalog officially authorized and licensed by ChryslerLLC.

A Few Words About Product Safety: To help you make informed decisions about safety; this catalog and the instructions accompanying our products have provided certain information in the form of "Notices", "Warnings" and "Cautions". This information alerts you to potential hazards that could hurt you or others.

NOTICE This is a caution against anything which may cause damage to the vehicle or its equipment if the caution is ignored. The Notice includes information about how you can avoid or reduce those risks.

WARNING This is a signal telling you that you CAN be KILLED or SERIOUSLY HURT if you don't follow the Warning. The Warning includes information about what you must or must not do in order to reduce the risk of injury to yourself and others.

CAUTION This is a signal telling you that you or others CAN be HURT if you don't follow the instruction. The Caution includes information about how you can avoid those risks.

A FEW WORDS ABOUT PARTS AVAILABLE FROM THIS CATALOG.

PARTS IDENTIFIED AS MOPAR® APPROVED AUTHENTIC RESTORATION PRODUCTS™ REFLECT THAT THE PRODUCT IS LICENSED BY MOPAR® FOR MANUFACTURE BY THIRD PARTIES AND MEETS MOPAR® STANDARDS. OMIX-ADA® AND ITS LICENSEES ARE NOT AFFILIATED WITH CHRYSLER LLC. ALL PARTS LISTED ARE AFTERMARKET ORIGIN AND PART NUMBERS ARE FOR PURPOSES OF CROSS-REFERENCE ONLY. THE RUGGED RIDGE™ AND OUTLAND™ PARTS ARE OMIX-ADA® BRANDED PRODUCTS MANUFACTURED BY QUALIFIED THIRD PARTIES. PARTS LISTED UNDER PAGES 132-242, OTHER THAN MOPAR® APPROVED RESTORATION PARTS, ARE SUPPLIED BY QUALIFIED OMIX-ADA® VENDORS WORLDWIDE. (SEE LIMITED WARRANTY SUMMARY AT REAR OF THIS CATALOG).

THIS CATALOG MAY BE REPRODUCED BY INDEPENDENT RETAILERS UNDER LICENSE FROM OMIX-ADA®.

THIS CATALOG REPRODUCED UNDER LICENSE FROM OMIX-ADA INC.

PARTS IDENTIFIED WITH THE MOPAR AUTHENTIC RESTORATION PRODUCT EMBLEM ARE THE ONLY PARTS IN THIS CATALOG OFFICIALLY AUTHORIZED AND LICENSED BY CHRYSLER LLC.

ALL RIGHTS RESERVED. NO PART OF THIS CATALOG MAY BE REPRODUCED BY ANY MEANS, ELECTRONIC OR OTHERWISE, WITHOUT EXPLICIT WRITTEN AUTHORIZATION FROM OMIX-ADA, INC. © COPYRIGHT OMIX-ADA, INC.

BY ORDERING FROM THIS CATALOG THE PURCHASER AGREES TO THE FOLLOWING TERMS AND CONDITIONS: THIS CATALOG IS BEING DELIVERED AS IS AND OMIX-ADA, INC. OR LICENSEE MAKE NO WARRANTIES, EXPRESSED OR IMPLIED, ON MERCHANTABILITY OR FITNESS FOR ANY PARTICULAR PURPOSE. OMIX-ADA, INC. OR LICENSEE DISCLAIM ALL LIABILITY FOR DIRECT OR INDIRECT DAMAGES ARISING FROM THE USE OR PERFORMANCE OF THIS CATALOG OR THE PRODUCTS HEREIN. DEFECTIVE ITEMS WILL BE CREDITED OR REPLACED AT OMIX'S SOLE DISCRETION. OMIX IS NOT RESPONSIBLE FOR LABOR, CONSEQUENTIAL DAMAGES OR BODILY INJURIES ARISING FROM INSTALLING OR USING ITS PARTS, CATALOG OR LISTINGS. NO RETURNS ARE ALLOWED ON SPECIAL ORDERS, FACTORY DROPSHIPS, ELECTRICAL AND BODY PARTS. OMIX-ADA OR LICENSEE ARE NOT RESPONSIBLE FOR TECHNICAL ERRORS, OMISSIONS OR PRINTING ERRORS. PRICES, AVAILABILITY AND BRAND NAMES ARE SUBJECT TO CHANGE WITHOUT NOTICE.

JEEP®, WILLYS®, AMC™, WRANGLER™, CHEROKEE™, GRAND CHEROKEE™, LIBERTY™, CJ™, YJ™, XJ™, TJ™, JK™, ZJ™, WJ™, SJ™, KJ™, JEEP® GRILLE DESIGN AND OTHER NAMES USED IN THIS CATALOG ARE REGISTERED TRADEMARKS OF CHRYSLER LLC. OMIX-ADA OR ITS LICENSEES ARE NOT AFFILIATED WITH CHRYSLER LLC. ALL PARTS LISTED ARE AFTERMARKET REPLACEMENT PARTS. PART NUMBERS, ILLUSTRATIONS AND IMAGES USED FOR REFERENCE PURPOSE ONLY. NO IMPLICATION IS MADE THAT THESE ARE ORIGINAL EQUIPMENT PARTS, FROM THOSE SOURCES WHOSE PART NUMBERS ARE USED HERE FOR REFERENCE OR THAT THEY ARE APPROVED BY THOSE COMPANIES.

© OMIX-ADA, INC. 2010. ALL RIGHTS RESERVED.



WARNING

Your safety and the safety of other motorists is very important. Your Jeep® is an off road capable vehicle that readily lends itself to restoration and customization. As the owner of a modified suspension vehicle you are the person choosing the combination of suspension, wheels, tires, drive train and accessories that best fit your intended use. Likewise, you are the person responsible for the safety and legality of the vehicle you modify. In modifying your vehicle's suspension, balance your off-road capabilities against how the vehicle may actually be used off-road and on-road.

It is not practical or possible to warn about all hazards associated with your Jeep® restoration or modifying your suspension for improved off road capabilities. Start by familiarizing yourself with all vehicle manufacturers' instructions and warnings and the instructions and warnings accompanying your aftermarket product. Follow recommended maintenance procedures and routinely inspect your vehicle components for unusual wear or off-road damage. Restoration parts are direct replacements of original components and are not designed or warranted as meeting current safety standards (including FMVSS).

Always wear seat belts and/or appropriate off-road restraints, reduce your speed, tread lightly™ and safely enjoy your off-road vehicle.

Body



- » Replace Steel Body Tubs and Body Kits from 1941 – 1986
- » Replacement Body Panels from 1941 – 2010
- » Jeep®/Willys Licensed Body Tubs, Kits & Panels Available!
- » Body Tubs are completely assembled, and primed. Ready to be shipped to your door.
- » 16 gauge steel used on body tubs for all side and tail panels. In most cases it is thicker than original!
- » 18 Gauge steel used on body tubs in the front and rear flooring, all mounting brackets, top cowl assembly, and wheel housings.
- » Manufactured using a seven-step metal preparation process, including:
 - A 5 bath dip to totally eliminate rust, dirt and grease.
 - A phosphate and acid rinse step to ensure corrosion resistance and proper adhesion of the primer.
 - New primer formula and application method that is designed for a smooth and even finish.
- » Includes all major factory mounting locations, including channels for body mounting.
- » Dashes and shifter tunnels left blank in some applications with varied OE locations.

REBUILT ENTIRELY FROM PARTS LISTED IN THE CATALOG!

Our body panels are more than just parts; they are built with a legacy and heritage in mind. No other supplier can match Omix's passion and dedication to quality. This is why we have been authorized to use the "MOPAR Authentic Restoration" and "MOPAR Official Licensed Product" logos for the more than 30 licensed body tubs and panels we produce. We take pride in being one of the few manufacturers strong enough to stand behind the legendary Jeep® name.

Our Body Tub is a completely assembled body shell from the firewall to the tail light panel. Fitted, welded and assembled together with the cowl panel, rear wheel housings, dash panel, and glove box already in place. Or you can upgrade to a Body Tub Kit. It features the same great body tub, (2) front fenders, windshield frame, hood and tailgate. It is the ultimate restoration accessory, primed and shipped to your door.

No more grinding, welding, or cutting out rusty panels, just to struggle as you fight to line up the new part. All the hard work is done for you. Primed and nearly ready for paint. The hardest part will be picking out the new paint color. How quickly can you say Olive Drab?

Of course the body tubs are not completely finished, there will still be some fitting and working to make everything line up. Just the same; as if you were working with a 50 year old body tub. –But our tubs are as you close as you can get today to a body off the original Toledo assembly line. Why else would MOPAR authorize us to use the "Willys" and "Jeep" scripts on the officially licensed bodies and panels we produce?

1 JEEP BODY KITS

DESCRIPTION

WILLYS MB 41-42 (3/1/42). BODY WITH FENDERS, HOOD, WINDSHIELD & TAILGATE
 WILLYS MB 42-43 (3/42 TO 12/43). BODY WITH FENDERS, HOOD, WINDSHIELD & TAILGATE
 WILLYS MB 43-45. BODY WITH FENDERS, HOOD, WINDSHIELD & TAILGATE
 FORD GPW 41-45. BODY WITH FENDERS, HOOD, WINDSHIELD & TAILGATE
 WILLYS M38 48-53. BODY WITH FENDERS, HOOD, WINDSHIELD & TAILGATE
 WILLYS M38A1 52-68. BODY WITH FENDERS, HOOD, WINDSHIELD & TAILGATE
 WILLYS CJ2A 46-49. BODY WITH FENDERS, HOOD, WINDSHIELD & TAILGATE
 WILLYS CJ3A 48-53. BODY WITH FENDERS, HOOD, WINDSHIELD & TAILGATE
 JEEP CJ3B 53-64. BODY WITH FENDERS, HOOD, WINDSHIELD & TAILGATE
 JEEP CJ5 55-68. BODY WITH FENDERS, HOOD, WINDSHIELD & TAILGATE
 JEEP CJ5 69. BODY WITH FENDERS, HOOD, WINDSHIELD & TAILGATE
 JEEP CJ5 70-71. BODY WITH FENDERS, HOOD, WINDSHIELD & TAILGATE
 JEEP CJ5 72-75. BODY WITH FENDERS, HOOD, WINDSHIELD & TAILGATE
 JEEP CJ6 55-68. BODY WITH FENDERS, HOOD, WINDSHIELD & TAILGATE
 JEEP CJ5 76-83. BODY WITH FENDERS, HOOD, WINDSHIELD & TAILGATE
 JEEP CJ7 76-86. BODY WITH FENDERS, HOOD, WINDSHIELD & TAILGATE
 JEEP CJ8 SCRAMBLER 81-86. BODY WITH FENDERS, HOOD, WINDSHIELD & TAILGATE
 JEEP CJ6 69-71, BODY WITH FENDERS, HOOD, WINDSHIELD & TAILGATE

PART No.

12001.03
 12001.20
 12001.02
 12001.04
 12001.05
 12001.15
 12001.07
 12001.08
 12001.09
 12001.10
 12001.11
 12001.12
 12001.13
 12001.14
 12001.16
 12001.17
 12001.18
 12001.19



12002.02



12002.06



12002.14

2 JEEP BODY TUBS

DESCRIPTION

WILLYS MB 41-42 (UNTIL 3/1/42)
 WILLYS MB 42-45 (FROM 3/1/42)
 FORD GPW 41-45
 WILLYS M38 48-53
 WILLYS CJ2A 46-49
 WILLYS CJ3A 48-53
 JEEP CJ3B 53-64
 JEEP CJ5 55-69
 JEEP CJ5 70-71
 JEEP CJ5 72-75
 JEEP CJ6 55-71
 JEEP CJ5 76-83
 JEEP CJ7 76-86
 JEEP CJ8 SCRAMBLER 81-86

PART No.

12002.02
 12002.01
 12002.03
 12002.04
 12002.06
 12002.07
 12002.08
 12002.09
 12002.10
 12002.11
 12002.12
 12002.13
 12002.14
 12002.15

Body kits, body tubs and body parts are sold "As Is". See Limited Warranty Information inside back cover. Drilling, cutting and other modifications may be required for proper installation. Claims for freight damage must be placed with freight carriers.

Nothing represents a Jeep® more than its very name! It's just not the same unless, well, it says "Jeep®"! The visual appearance of the name stands for a legacy and history that no other vehicle in the world can match. Now you can return your Jeep® to its original markings with these stamped Hoods, Tailgates, Back Panels, Toolbox, Body Tubs, Valve Covers, Grilles and Dash Pads!



WILLYS® & JEEP® MARKED ITEMS

1 LICENSED JEEP BODY TUBS AND KITS

DESCRIPTION	PART No.
WILLYS CJ2A 46-49, WILLYS STAMPED, BODY WITH FENDERS, HOOD W/ WILLYS SCRIPT, WINDSHIELD & TAILGATE W/ WILLYS SCRIPT	DMC-673859-2A WILLYS CJ3A 48-53, WILLYS STAMPED, BODY WITH FENDERS, HOOD W/ WILLYS SCRIPT, WINDSHIELD & TAILGATE W/ WILLYS SCRIPT
WILLYS CJ3B 53-64, WILLYS STAMPED, BODY WITH FENDERS, HOOD W/ WILLYS SCRIPT, WINDSHIELD & TAILGATE W/ WILLYS SCRIPT	DMC-673859-3A
JEEP CJ5 76-83, WITH JEEP SCRIPT STAMPED IN COWL SIDES	DMC-693197
JEEP CJ7 76-86, WITH JEEP SCRIPT STAMPED IN COWL SIDES	DMC-5461335
JEEP CJ5 55-69, WITH JEEP SCRIPT STAMPED IN COWL SIDES	DMC-5464362
JEEP CJ5 70-71, WITH JEEP SCRIPT STAMPED IN COWL SIDES	DMC-680637
JEEP CJ5 72-75, WITH JEEP SCRIPT STAMPED IN COWL SIDES	DMC-680637-VC

2 VALVE COVERS

DESCRIPTION	PART No.
"JEEP®" MARKED VALVE COVER: FOR 1981-87 6 CYL ENGINE	DMC-6914
"JEEP®" MARKED VALVE COVER, PAIR: FOR 1968-91 V8 AMC	DMC-6920

3 DASHPADS

DESCRIPTION	PART No.
"JEEP®" MARKED DASHPAD: FOR 1976-86 CJ, BLACK	DMC-5760458
"JEEP®" MARKED DASHPAD: FOR 1976-86 CJ, LIGHT GRAY	DMC-5760459

4 WINDSHIELD FRAME & TOOLBOX

DESCRIPTION	PART No.
"WILLYS®" WINDSHIELD FRAME: FOR 1946-53 CJ2A	DMC-663628
"JEEP®" TOOLBOX: FOR 1946-75 CJ's	DMC-3227K

5 GRILLES

DESCRIPTION	PART No.
FOR CJ2A EARLY 1945-46	DMC-663536
FOR CJ2A LATE 1947-49	DMC-668124
FOR CJ3A 1949-53	DMC-673149
FOR CJ3B 1959-64 WITH "WILLYS®" MARK	DMC-681798
FOR CJ5, 1955-71	DMC-815385
FOR CJ6, 1955-71	DMC-815385
FOR CJ, 1972-86	DMC-5752656

6 HOODS

DESCRIPTION	PART No.
"WILLYS®" MARKED HOOD: FOR 1946-53 CJ2A, CJ3A	DMC-670969
"WILLYS®" MARKED HOOD: FOR 1953-64 CJ3B	DMC-681334

7 TAILGATES

DESCRIPTION	PART No.
"WILLYS®" MARKED TAILGATE: FOR 1946-68 CJ	DMC-663188
"WILLYS®" MARKED BACK PANEL: FOR 1941-45 MB	DMC-2758
"JEEP®" MARKED TAILGATE: FOR 1969-83 CJ5	DMC-685459
"JEEP®" MARKED TAILGATE: FOR 1976-86 CJ7	DMC-5454025

Body kits, body tubs and body parts are sold "As Is". See Limited Warranty Information inside back cover. Drilling, cutting and other modifications may be required for proper installation. Claims for freight damage must be placed with freight carriers.



1 HEADLIGHT ASSEMBLIES

DESCRIPTION	PART No.
1972-86 CJ (each)	12402.01
1972-86 CJ (pair)	12402.02
1997-06 WRANGLER, RIGHT	12402.04
1997-06 WRANGLER, LEFT	12402.03
2007-10 WRANGLER, RIGHT (NEW)	12402.20
2007-10 WRANGLER, LEFT (NEW)	12402.21
1993-98 GRAND CHEROKEE, RIGHT	12402.06
1993-98 GRAND CHEROKEE, LEFT	12402.07
1999-04 GRAND CHEROKEE LAREDO, RIGHT	12402.08
1999-04 GRAND CHEROKEE LAREDO, LEFT	12402.09
1999-04 GRAND CHEROKEE LIMITED, RIGHT	12402.10
1999-04 GRAND CHEROKEE LIMITED, LEFT	12402.11
2005-07 GRAND CHEROKEE, RIGHT (NEW)	12402.18
2005-07 GRAND CHEROKEE, LEFT (NEW)	12402.19
2002 LIBERTY (through 11/5/02), RIGHT	12402.12
2002 LIBERTY (through 11/5/02), LEFT	12402.13
2002-04 LIBERTY (starting 11/6/02), RIGHT	12402.14
2002-04 LIBERTY (starting 11/6/02), LEFT	12402.15
2005-07 LIBERTY, RIGHT	12402.16
2005-07 LIBERTY, LEFT	12402.17

2 ROUND SEALED BEAM HEADLIGHT BULBS

DESCRIPTION	PART No.
1941-45 MB, GPW, SEALED BEAM, 6V	12409.03
1965-86 CJ, SEALED, 12V	12409.01
1946-64 CJ, SEALED, 6V	12409.02
1965-86 CJ, HALOGEN	12409.04
1997-06 WRANGLER	12409.04

3 RECTANGULAR HALOGEN HEADLIGHTS

DESCRIPTION	PART No.
1987-95 WRANGLER	12409.05
1984-01 CHEROKEE	12409.05

4 HEADLIGHT HOUSINGS

DESCRIPTION	PART No.
MB & GPW, WITHOUT BULB	12402.05
1987-95 WRANGLER, RH	12421.02
1987-95 WRANGLER, LH	12421.01
1984-01 CHEROKEE, RH	12421.02
1984-01 CHEROKEE, LH	12421.01
* NEUTRAL - PAINT TO MATCH	

5 HEADLIGHT RETAINING RINGS

DESCRIPTION	PART No.
1972-86 CJ	12420.01
1997-06 WRANGLER	12420.02
1987-95 WRANGLER	12420.03
1984-01 CHEROKEE	12420.03

6 HEADLIGHT BEZELS

DESCRIPTION	PART No.
1945-49 CJ2A, CHROME (each)	12419.01
1948-53 CJ3A, CHROME (each)	12419.01
1953-65 CJ3B, CHROME (each)	12419.02
1955-71 CJ5, CHROME (each)	12419.02
1955-71 CJ6, CHROME (each)	12419.02
1972-86 CJ, CHROME (each)	12419.03
1972-86 CJ, CHROME (pair)	12419.04
1987-95 WRANGLER, CHROME, LEFT	12419.21
1987-95 WRANGLER, CHROME, RIGHT	12419.22
1987-95 WRANGLER, CHROME, (pair)	12419.05
1997-06 WRANGLER, CHROME, RIGHT	12419.06
1997-06 WRANGLER, CHROME, LEFT	12419.07
1997-06 WRANGLER, PAIR, CHROME	12419.08
1997-06 WRANGLER, BLACK (pair)	12419.23
1987-96 WRANGLER, BLACK (pair)	12419.24
1984-01 CHEROKEE, GRAY, RIGHT	12419.10
1984-01 CHEROKEE, GRAY, LEFT	12419.09
1984-01 CHEROKEE, CHROME, RIGHT	12419.12
1984-01 CHEROKEE, CHROME, LEFT	12419.11
1991-96 CHEROKEE, BLACK/CHROME, RIGHT	12419.14
1991-96 CHEROKEE, BLACK/CHROME, LEFT	12419.13
1993-96 CHEROKEE, BLACK, RIGHT	12419.16
1993-96 CHEROKEE, BLACK, LEFT	12419.15
1997-01 CHEROKEE, BLACK, RIGHT	12419.18
1997-01 CHEROKEE, BLACK, LEFT	12419.17
1997-01 CHEROKEE, RIGHT	12419.20
1997-01 CHEROKEE, LEFT	12419.19

7 HEADLIGHT ADJUSTING HARDWARE

DESCRIPTION	PART No.
HEADLIGHT ADJUSTING SCREW, 1972-86 CJ	12410.01

8 FOG LIGHTS

DESCRIPTION	PART No.
2007-10 WRANGLER, RH=LH	12407.12
1993-95 CHEROKEE, RH=LH	12407.09
1997-01 CHEROKEE, RIGHT	12407.02
1997-01 CHEROKEE, LEFT	12407.01
1993-95 GRAND CHEROKEE RH=LH	12407.09
1997-98 GRAND CHEROKEE, RIGHT	12407.06
1997-98 GRAND CHEROKEE, LEFT	12407.05
1999-03 GRAND CHEROKEE, RIGHT	12407.04
1999-03 GRAND CHEROKEE, LEFT	12407.03
2005-07 GRAND CHEROKEE, RH=LH	12407.11
2002-04 LIBERTY, RIGHT	12407.08
2002-04 LIBERTY, LEFT	12407.07
2005-06 LIBERTY EXCEPT RENEGADE, RH=LH	12407.10
2007-10 JK Fog Light (NEW)	12407.12



1 FRONT TURN SIGNAL LIGHTS

DESCRIPTION	PART No.
1993-98 GRAND CHEROKEE, CLEAR RIGHT (U.S.)	12401.14
1993-98 GRAND CHEROKEE, CLEAR LEFT (U.S.)	12401.13
1993-98 GRAND CHEROKEE, AMBER, RIGHT (export only)	12401.16
1993-98 GRAND CHEROKEE, AMBER, LEFT (export only)	12401.15

2 PARK & TURN SIGNAL LIGHTS

DESCRIPTION	PART No.
1955-71 CJ LAMP ASSEMBLY (amber)	12405.01
1955-71 CJ LAMP ASSEMBLY (clear)	12405.02
1955-71 CJ LENS ONLY (amber)	12405.03
1955-71 CJ LENS ONLY (clear)	12405.04
1976-86 CJ LAMP ASSEMBLY WITH CLEAR LENS	12405.06
1976-86 CJ LAMP ASSEMBLY WITH AMBER LENS (export)	12405.07
1976-86 CJ LENS ONLY, CLEAR	12405.08
1976-86 CJ LENS ONLY, AMBER (export)	12405.09
1987-93 WRANGLER, LH OR RH (amber)	12405.10
1997-06 WRANGLER	12405.11
2007-10 WRANGLER, RIGHT (amber) (NEW)	12405.24
2007-10 WRANGLER, LEFT (amber) (NEW)	12405.25
1984-96 CHEROKEE, RIGHT	12405.12
1984-96 CHEROKEE, LEFT	12405.13
1997-01 CHEROKEE, RIGHT	12405.14
1997-01 CHEROKEE, LEFT	12405.15
1993-98 GRAND CHEROKEE, RIGHT	12405.16
1993-98 GRAND CHEROKEE, LEFT	12405.17
2002-04 LIBERTY, RIGHT	12401.18
2002-04 LIBERTY, LEFT	12401.17
2005-06 LIBERTY, RIGHT	12401.22
2005-06 LIBERTY, LEFT	12401.23

3 SIDE MARKER LIGHTS

DESCRIPTION	PART No.
1976-86 CJ, AMBER SIDE MARKER LENS, FRONT	12401.01
1976-86 CJ, AMBER SIDE MARKER KIT (socket, wiring, bulb & lens)	12401.02
1976-86 CJ, RED SIDE MARKER LENS, REAR	12401.03
1976-86 CJ, RED SIDE MARKER KIT (socket, wiring, bulb & lens)	12401.04
1976-86 CJ, SOCKET & WIRING FOR SIDE MARKERS	12401.05
1987-95 WRANGLER, (amber)	12401.06
1997-06 WRANGLER, RIGHT (amber)	12401.08
1997-06 WRANGLER, LEFT (amber)	12401.07
2007-10 WRANGLER, RIGHT (amber) (NEW)	12401.24
2007-10 WRANGLER, LEFT (amber) (NEW)	12401.25
1984-96 CHEROKEE, RIGHT	12401.10
1984-96 CHEROKEE, LEFT	12401.09
1997-01 CHEROKEE, RIGHT	12401.12
1997-01 CHEROKEE, LEFT	12401.11
2005-06 LIBERTY, RIGHT	12401.20
2005-06 LIBERTY, LEFT	12401.21

4 BACK-UP LIGHTS

DESCRIPTION	PART No.
1946-75 CJ, ASSEMBLY (includes socket, bulb & wiring)	12406.01
1955-75 CJ, LENS ONLY	12405.04

5 TAIL LIGHTS

DESCRIPTION	PART No.
1941-45 MB AND GPW, ASSEMBLY WITH LENS, LEFT	12403.51
1941-45 MB AND GPW, ASSEMBLY WITH LENS, RIGHT	12403.52
1941-45 MB AND GPW, TAIL LAMP BUCKET ASSEMBLY (without lens or bulb), RH=LH	12403.50
1946-75 CJ, ROUND, LEFT	12403.01
1946-75 CJ, ROUND, RIGHT	12403.02
1976-86 CJ, LENS FOR ALL TAIL LIGHTS	12404.01
1976-80 CJ, LEFT, BLACK	12403.03
1976-80 CJ, LEFT, CHROME	12403.05
1976-80 CJ, RIGHT, BLACK	12403.04
1976-80 CJ, RIGHT, CHROME	12403.06
1981-86 CJ, RIGHT, BLACK	12403.08
1981-86 CJ, RIGHT, CHROME	12403.10
1981-86 CJ, LEFT, BLACK	12403.07
1981-86 CJ, LEFT, CHROME	12403.09
1987-97 WRANGLER, LENS FOR ALL TAIL LIGHTS	12404.01
1991-97 WRANGLER, RIGHT, BLACK	12403.14
1991-97 WRANGLER, RIGHT, CHROME	12403.16
1991-97 WRANGLER, LEFT, BLACK	12403.13
1991-97 WRANGLER, LEFT, CHROME	12403.15
1984-96 CHEROKEE, RIGHT	12403.18
1984-96 CHEROKEE, LEFT	12403.17
1997-01 CHEROKEE, RIGHT	12403.20
1997-01 CHEROKEE, LEFT	12403.19
1993-98 GRAND CHEROKEE, RIGHT	12403.22
1993-98 GRAND CHEROKEE, LEFT	12403.21
1999-04 GRAND CHEROKEE, RIGHT	12403.24
1999-04 GRAND CHEROKEE, LEFT	12403.23
2005-06 GRAND CHEROKEE, LEFT	12403.33
2005-06 GRAND CHEROKEE, RIGHT	12403.32
2007-10 GRAND CHEROKEE, RIGHT (NEW)	12403.34
2007-10 GRAND CHEROKEE, LEFT (NEW)	12403.35
2002-04 LIBERTY, RIGHT	12403.26
2002-04 LIBERTY, LEFT	12403.25
2005-07 LIBERTY WITHOUT AIR DAM, LEFT	12403.29
2005-07 LIBERTY WITHOUT AIR DAM, RIGHT	12403.28
2005-07 LIBERTY WITH AIR DAM, LEFT	12403.31
2005-07 LIBERTY WITH AIR DAM, RIGHT	12403.30

6 1976-95 CJ & WRANGLER FLASHER RELAYS

DESCRIPTION	PART No.
2 BLADE (552)	12411.01
2 BLADE (224)	12411.02
3 BLADE (550)	12411.03

7 REPLACEMENT LIGHT BULBS

DESCRIPTION	PART No.
1972-86 CJ, FRONT PARKING LAMP BULB (amber)	12408.01
1972-86 CJ, SIDE MARKER BULB	12408.06
1976-86 CJ, REAR BACK-UP BULB	12408.04
1976-86 CJ, REAR STOP, TURN & TAIL LIGHT BULB	12408.05
1984-06 ALL, INTERIOR COURTESY LIGHT BULB	12408.07
1987-06 WRANGLER, REAR BACK-UP BULB	12408.04
1987-06 WRANGLER, REAR STOP, TURN & TAIL LIGHT BULB	12408.05
1987-93 WRANGLER, FRONT PARKING LAMP BULB	12408.02
1987-98 WRANGLER, SIDE MARKER BULB	12408.06
1994-06 WRANGLER, FRONT PARKING LAMP BULB	12408.03
2003-06 WRANGLER INTERIOR DOME LIGHT BULB	12408.08



1 WINDSHIELD GLASS SEALS

DESCRIPTION	PART No.
1941-49 MB, CJ2A (seal between inner & outer windshield)	12301.01
1941-49 MB, CJ2A GLASS SEAL (2 needed)	12301.02
1951-75 M38, M38A1, CJ3A, CJ3B, CJ5, CJ6	12301.03
1976-86 CJ	12301.04
1987-95 WRANGLER, GLASS SEAL	12301.05
1997-06 WRANGLER, SEAL, INNER WINDSHIELD	12301.09

2 WINDSHIELD GLASS HARDWARE

DESCRIPTION	PART No.
1987-95 WRANGLER, GLASS SEAL LOCK ONLY	12301.06
1987-95 WRANGLER, WINDSHIELD GLASS SEAL CLIP	12301.07
1997-06 WRANGLER, WINDSHIELD REVEAL MOLDING	12301.08

3 COWL RUBBER SEALS

DESCRIPTION	PART No.
1941-63 MB, M38, CJ2A, CJ3A, CJ3B	12302.01
1951-75 CJ5, CJ6	12302.02
1976-86 CJ	12302.03
1987-95 WRANGLER	12302.04
1997-02 WRANGLER	12302.05

4 DOOR SEALS

DESCRIPTION	PART No.
1976-86 CJ DOOR WEATHER SEAL PASS. SIDE (RH)	12303.02
1987-95 WRANGLER DOOR WEATHER SEAL PASSENGER SIDE (RH)	12303.02
1976-86 CJ DOOR WEATHER SEAL, DRIVER SIDE (LH)	12303.01
1987-95 WRANGLER DOOR WEATHER SEAL, DRIVER SIDE (LH)	12303.01
1997-06 WRANGLER WITH FULL DOOR, RH, WEATHERSTRIP OUTER DOOR	12303.12
1997-06 WRANGLER WITH FULL DOOR, LH, WEATHERSTRIP OUTER DOOR	12303.13
1987-95 WRANGLER HALF DOOR WEATHER SEAL (RH)	12303.04
1987-95 WRANGLER HALF DOOR WEATHER SEAL (LH)	12303.03
1997-06 WRANGLER RH, HALF DOOR, OUTER SEAL	12303.14
1997-06 WRANGLER LH, HALF DOOR, OUTER SEAL	12303.15

5 DOOR WINDOW SEALS

DESCRIPTION	PART No.
1976-86 CJ, DOOR WINDOW REAR SEAL, LH=RH	12303.05
1987-95 WRANGLER, DOOR WINDOW REAR SEAL, LH=RH	12303.05

6 DOOR GLASS OUTER SEALS

DESCRIPTION	PART No.
1976-86 CJ, DOOR GLASS OUTER SEAL, RH	12303.06
1976-86 CJ, DOOR GLASS OUTER SEAL, LH	12303.07
1987-95 WRANGLER, DOOR GLASS OUTER SEAL, RH	12303.06
1987-95 WRANGLER, DOOR GLASS OUTER SEAL, LH	12303.07

7 DOOR GLASS INNER SEALS

DESCRIPTION	PART No.
1976-86 CJ, DOOR GLASS INNER SEAL, RH	12303.08
1976-86 CJ, DOOR GLASS INNER SEAL, LH	12303.09
1987-95 WRANGLER, DOOR GLASS INNER SEAL, RH	12303.08
1987-95 WRANGLER, DOOR GLASS INNER SEAL, LH	12303.09

8 DOOR GLASS EDGE SEALS

DESCRIPTION	PART No.
1982-86 CJ, DOOR EDGE SEAL W/ MOVABLE VENT WINDOW, LH=RH	12303.10
1987-95 WRANGLER, DOOR EDGE SEAL WITH MOVABLE VENT WINDOW, LH=RH	12303.10
1978-81 CJ, DOOR GLASS EDGE SEAL WITH STATIONARY VENT WINDOW	12303.11



1 HARDTOP, TAILGATE & LIFTGATE SEALS & COMPONENTS

DESCRIPTION	PART No.
A 1977-86 CJ7 LIFTGATE OUTER SEAL WITH PLASTIC LOCKS	12304.01
1987-95 WRANGLER, WEATHERSTRIP, REAR LIFT-GATE GLASS	12304.08
B 1977-86 CJ7 LIFTGATE INNER GLASS SEAL	12304.02
C 1976-86 CJ HARDTOP REAR SIDE WINDOW SEAL, RH-LH	12304.03
D 1977-86 HARDTOP TO WINDSHIELD FRAME SEAL	12304.04
D 1987-95 HARDTOP TO WINDSHIELD FRAME SEAL	12304.04
E 1977-86 CJ HARDTOP LIFTGATE HINGE	11901.01
F 1977-86 CJ HARDTOP T-HANDLE	11901.02
G 1976-86 CJ7 & CJ8 TAILGATE SEAL	12305.01
G 1987-95 WRANGLER TAILGATE SEAL	12305.02
G 1997-06 WRANGLER LOWER TAILGATE SEAL (NEW)	12305.03
1987-95 WRANGLER TAILGATE'S UPPER WEATHERSTRIP (between liftgate & tailgate)	12304.09
H 1987-95 WRANGLER CORNER HARDTOP SEAL, RH	12304.06
H 1987-95 WRANGLER CORNER HARDTOP SEAL, LH	12304.05
I 1977-86 HARDTOP SEAL KIT, CJ	12304.07
I 1987-95 HARDTOP SEAL KIT, WRANGLER	12304.07
J 1977-86 CAM & CABLE, CJ7 HARDTOP	11901.03
K 1977-86 LATCH ASSEMBLY, CJ7 HARDTOP, EACH	11901.04
1987-95 WRANGLER HARDTOP FASTENER KIT (NEW)	12215.11

2 SOFT TOP SEALS

DESCRIPTION	Part No.
1987-95 WRANGLER WITH FACTORY SOFT TOP, PLASTIC DOOR SEAL, RH	12306.04
1987-95 WRANGLER WITH FACTORY SOFT TOP, PLASTIC DOOR SEAL, LH	12306.03

3 SOFT TOP SEAL HARDWARE

DESCRIPTION	PART No.
1987-95 WRANGLER WITH FACTORY SOFT TOP, DOOR SEAL CLIP	12306.08
1987-95 WRANGLER REPLACEMENT SOFT TOP SNAPS	12306.07



OMIX-ADA®

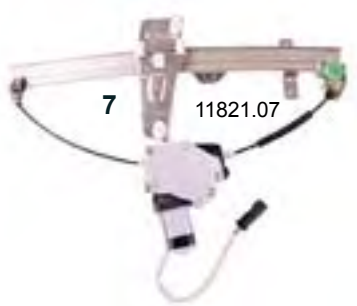
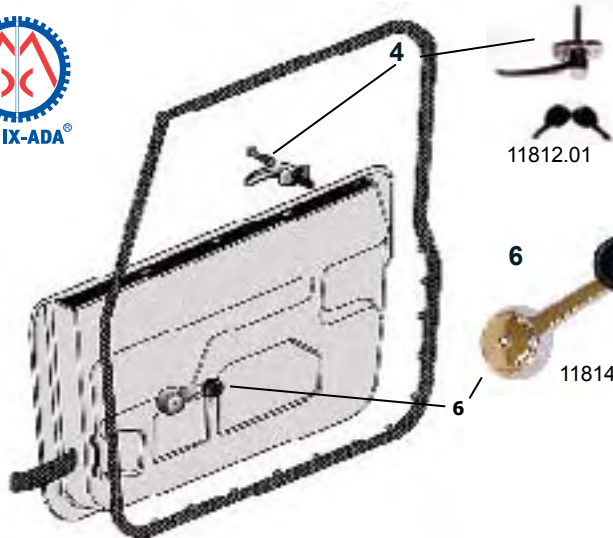

1 DOOR LATCH BRACKET KITS

DESCRIPTION	PART No.
1981-86 CJ FULL DOOR, LH	11810.01
1981-86 CJ, STAINLESS STEEL, LH	11810.03
1981-86 CJ FULL DOOR, RH	11810.02
1981-86 CJ, STAINLESS STEEL, RH	11810.04
1981-86 CJ, STAINLESS STEEL, RH & LH PAIR	11810.05
1987-95 WRANGLER FULL DOOR, LH	11810.01
1987-95 WRANGLER STAINLESS STEEL, LH	11810.03
1987-95 WRANGLER, FULL DOOR, RH	11810.02
1987-95 WRANGLER, STAINLESS STEEL, RH	11810.04
1987-95 WRANGLER, STAINLESS STEEL, RH & LH PAIR	11810.05

5 DOOR PADDLE HANDLES

DESCRIPTION	PART No.
1981-86 CJ WITH FULL STEEL DOOR, BLACK, LH	11812.05
1981-86 CJ WITH FULL STEEL DOOR, BLACK, RH	11812.06
1981-86 CJ WITH FULL STEEL DOOR, CHROME, LH	11812.03
1981-86 CJ WITH FULL STEEL DOOR, CHROME, RH	11812.04
1987-95 WRANGLER WITH FULL STEEL DOOR, BLACK, LH	11812.05
1987-95 WRANGLER WITH FULL STEEL DOOR, BLACK, RH	11812.06
1987-95 WRANGLER WITH FULL STEEL DOOR, CHROME, LH	11812.03
1987-95 WRANGLER WITH FULL STEEL DOOR, CHROME, RH	11812.04
1997-06 WRANGLER WITH FULL STEEL DOOR, BLACK, LH	11812.06
1997-06 WRANGLER WITH FULL STEEL DOOR, BLACK, RH	11812.05
1997-06 WRANGLER WITH FULL STEEL DOOR, CHROME, LH	11812.04
1997-06 WRANGLER WITH FULL STEEL DOOR, CHROME, RH	11812.03

*Please note: In 1997 Jeep® inverted the door handle design. LH and RH for 1997-06 are flipped when compared to the 1981-95 versions.

2 DOOR LATCH PLATES

DESCRIPTION	PART No.
1981-86 CJ FULL DOOR, RH=LH	11811.01
1987-95 WRANGLER FULL DOOR, RH=LH	11811.01

6 WINDOW CRANKS

DESCRIPTION	PART No.
1976-86 CJ, WINDOW CRANK HANDLE	11814.01
1987-91 WRANGLER, WINDOW CRANK HANDLE	11814.01

3 DOOR LATCH PINS

DESCRIPTION	PART No.
1981-86 CJ FULL DOOR, LATCH PIN, RH=LH	11811.02
1987-95 WRANGLER FULL DOOR, LATCH PIN, RH=LH	11811.02

7 FRONT WINDOW REGULATORS

DESCRIPTION	PART No.
1993-98 GRAND CHEROKEE, LH Manual	11821.01
1993-98 GRAND CHEROKEE, LH Power	11821.03
1993-98 GRAND CHEROKEE, RH Manual	11821.02
1993-98 GRAND CHEROKEE, RH Power	11821.04
1999-00 GRAND CHEROKEE, LH	11821.05
1999-00 GRAND CHEROKEE, RH	11821.06
2001-04 GRAND CHEROKEE, LH	11821.08
2001-04 GRAND CHEROKEE, RH	11821.07

4 DOOR HANDLES

DESCRIPTION	PART No.
1976-80 CJ WITH HARDTOP, DOOR HANDLE WITH KEY	11812.01
1976-80 CJ WITH HARDTOP, DOOR HANDLE WITH KEY, PAIR (pair uses same key)	11812.02

8 DOOR FOOTMAN LOOPS

DESCRIPTION	PART No.
1976-86 CJ, STAINLESS (kit)	11105.01
1987-95 WRANGLER, STAINLESS (kit)	11105.01



11812.08



12042.32



12042.31



11801.01



11813.11



13317.01



11817.01

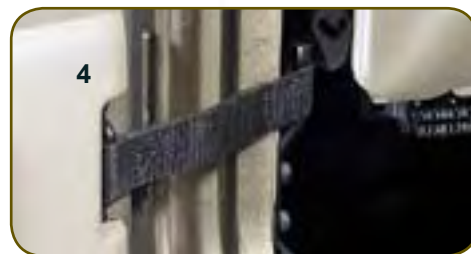

12103.01



11813.08



11813.02



11813.05



11818.01



11818.09



11818.37



1 OUTER TAILGATE HANDLES

DESCRIPTION	PART No.
1987-95 WRANGLER	11812.08
1997-06 WRANGLER	11812.10

2 OUTER DOOR HANDLES

DESCRIPTION	PART No.
1987-06 WRANGLER WITH FACTORY HALF DOORS, RIGHT	11812.08
1987-06 WRANGLER WITH FACTORY HALF DOORS, LEFT	11812.09
2002-07 LIBERTY, LEFT FRONT	12042.31
2002-07 LIBERTY WITH LOCK, RIGHT FRONT	12042.32
2002-07 LIBERTY, LEFT REAR	12042.35
2002-07 LIBERTY, RIGHT REAR	12042.36
2004-07 LIBERTY, RIGHT FRONT WITHOUT LOCK	12042.34

3 OE STYLE INNER DOOR HANDLES

DESCRIPTION	PART No.
1976-86 CJ BLACK, WITHOUT HARDWARE	11801.01
1987-95 WRANGLER HANDLE KIT, BLACK, WITH HARDWARE (2 screws & 2 cover pcs), FOR HALF OR FULL DOORS	11816.01
1987-95 WRANGLER HANDLE KIT, SPICE, WITH HARDWARE (2 screws & 2 cover pcs), FOR HALF OR FULL DOORS	11816.37
1987-95 WRANGLER HANDLE KIT GRAY, WITH HARDWARE (2 screws & 2 cover pcs), FOR HALF OR FULL DOORS	11816.09
1991-02 WRANGLER, PASS. SIDE, FOR HALF OR FULL DOORS	11812.12
1991-02 WRANGLER, DRIVER SIDE, FOR HALF OR FULL DOORS	11812.13

4 DOOR STRAPS

DESCRIPTION	PART No.
1976-86 CJ DOOR STRAP (each)	11817.01
1976-86 CJ ADJUSTABLE DOOR STRAP (pair)	12103.01
1987-95 WRANGLER DOOR STRAP (each)	11817.01
1987-06 WRANGLER ADJUSTABLE DOOR STRAP (pair)	12103.01

5 GLOVE BOX LOCKS & CYLINDERS

DESCRIPTION	PART No.
1976-86 CJ LATCH BRACKET, GLOVE BOX LOCK	13317.01
1972-86 CJ LATCH ASSEMBLY GLOVE BOX (push button, non-lockable version)	11813.11

6 DOOR LOCKS & CYLINDERS

DESCRIPTION	PART No.
1981-86 CJ HARDTOP DOOR LOCK & KEY SET, PAIR (BOTH SIDES)	11813.02
1974-91 SJ	11813.08
1987-90 WRANGLER HARDTOP DOOR LOCK & KEY, PAIR (both sides)	11813.02
1991-94 WRANGLER	11813.03
1995-02 WRANGLER	11813.04
2003-10 WRANGLER	11813.05
1991-94 CHEROKEE	11813.03
1995-97 CHEROKEE	11813.04
1998-01 CHEROKEE	11813.05
1993-94 GRAND CHEROKEE	11813.03
1995 GRAND CHEROKEE	11813.04
1996-98 GRAND CHEROKEE	11813.05
1999-04 GRAND CHEROKEE	11813.06
2002-03 LIBERTY	11813.07
2004 LIBERTY	11813.06

7 TAILGATE LOCKS & CYLINDERS

DESCRIPTION	PART No.
1991-94 WRANGLER	11813.09
1995 WRANGLER	11813.10
1997 WRANGLER	11813.10
1998-02 WRANGLER	11813.04
2003-06 WRANGLER	11813.05

8 GROMMETS FOR DOOR TRIM PANELS 1987-06 WRANGLER WITH HALF DOORS

DESCRIPTION	PART No.
SPICE (3 required per door)	11818.37
GRAY (3 required per door)	11818.09
BLACK (3 required per door)	11818.01



5 1997-06 WRANGLER

DESCRIPTION	PART No.
FLARE KIT (6 pieces) INCLUDES	
4 FLARES, 2 EXTENSIONS & HARDWARE*	11603.01
FLARE KIT (6 pieces) INCLUDES 4 FLARES & 2 EXTENSIONS*	11603.11
FLARE KIT (4 pieces) FLARES ONLY HARDWARE NOT INCLUDED*	11603.02
FRONT PASSENGER SIDE* FLARE	11603.04
FRONT DRIVER SIDE* FLARE	11603.03
REAR PASSENGER SIDE FLARE	11603.06
REAR DRIVER SIDE FLARE	11603.05
DRIVER SIDE FLARE EXTENSION	11603.07
PASSENGER SIDE FLARE EXTENSION	11603.08
HARDWARE KIT	11603.09
*Will not fit Sahara Models	

6 2007-10 WRANGLER

DESCRIPTION	PART No.
2007-10 KIT (4 pieces) (includes hardware) (NEW)	11609.01
2007-10 DRIVER SIDE FLARE, FRONT (NEW)	11609.11
2007-10 PASSENGER SIDE FLARE, FRONT (NEW)	11609.10
2007-10 PASSENGER SIDE, REAR (NEW)	11609.12
2007-10 DRIVER SIDE, REAR (NEW)	11609.13
*Will not fit Sahara Models	

7 7" FENDER FLARES & KITS

Improve your vehicles aggressive, rugged looks with **Rugged Ridge 7" Fender Flares**. Not just for looks - These durable thermoplastic flares also provide added protection from road debris and stone chips

DESCRIPTION	PART No.
1976-86 CJ, 7" FLARE KIT: (4 pieces) WITH HARDWARE*	11606.01
1955-86 CJ, 7" FRONT PASSENGER SIDE (RH) FLARE	11606.02
1955-86 CJ, 7" FRONT DRIVER SIDE (LH) FLARE	11606.03
1987-95 WRANGLER, 7" FLARE KIT: (6 pcs) WITH HARDWARE *	11607.01
1987-95 WRANGLER, 7" FENDER FLARE, FRONT RH WITHOUT HARDWARE	11607.02
1987-95 WRANGLER, 7" FENDER FLARE FRONT LH WITHOUT HARDWARE	11607.03
1997-06 WRANGLER, 7" FLARE KIT: 6 PIECES: (2) FRONT RH & LH & (2) REAR RH & LH, (2) EXTENSIONS RH & LH, WITH HARDWARE	11608.01
1997-06 WRANGLER, 7" FLARE KIT: 6 PIECES: (2) FRONT RH & LH & (2) REAR RH & LH, (2) EXTENSION RH & LH, WITHOUT HARDWARE	11608.11
1997-06 WRANGLER, 7" FLARE FRONT RH	11608.02
1997-06 WRANGLER, 7" FLARE FRONT LH	11608.03
1997-06 WRANGLER, 7" FLARE REAR RH	11608.04
1997-06 WRANGLER, 7" FLARE REAR LH	11608.05

* Rugged Ridge's 7" CJ & YJ Fender Flares use a TJ Style Rear Flare enabling it to cover a larger wheel space. This feature also makes it necessary to cut the rear wheel housings to accept a larger size tire. Cutting & drilling required on 1976-95 models. Not designed for Sahara models. Rubicon models do not require side extensions.

1 1955-86 CJ-5 & CJ-7

DESCRIPTION	PART No.
COMPLETE KIT WITH HARDWARE (4 pieces)	11601.01
FRONT DRIVER SIDE FLARE	11601.03
FRONT PASSENGER SIDE FLARE	11601.02
REAR DRIVER SIDE FLARE	11601.05
REAR PASSENGER SIDE FLARE	11601.04
HARDWARE KIT (plastic locks & screws)	11601.06

2 1981-86 CJ-8 SCRAMBLER

DESCRIPTION	PART No.
COMPLETE KIT WITH HARDWARE (4 pieces)	11604.01
FRONT DRIVER SIDE FLARE	11601.03
FRONT PASSENGER SIDE FLARE	11601.02
REAR PASSENGER SIDE	11604.02
REAR DRIVER SIDE	11604.03

3 1984-96 CHEROKEE

Finally, A Fender Flare Kit for The CHEROKEE Series!

DESCRIPTION	PART No.
COMPLETE KIT WITH HARDWARE (4 pieces)	11605.01
FRONT DRIVER SIDE	11605.03
FRONT PASSENGER SIDE	11605.02
REAR DRIVER SIDE	11605.05
REAR PASSENGER SIDE	11605.04

4 1987-95 WRANGLER

DESCRIPTION	PART No.
FLARE KIT (6 pieces) INCLUDES 4 FLARES, 2 EXTENSIONS, BRACKETS AND HARDWARE KIT	11602.01
FLARE KIT (4 pieces) INCLUDES: 4 FLARES & HARDWARE KIT	11602.02
FRONT DRIVER SIDE FLARE	11602.03
FRONT PASSENGER SIDE FLARE	11602.04
REAR DRIVER SIDE FLARE	11602.05
REAR PASSENGER SIDE FLARE	11602.06
FRONT EXTENSION, DRIVER SIDE FLARE	11602.07
FRONT EXTENSION, PASSENGER SIDE FLARE	11602.08
HARDWARE KIT (plastic locks & screws)	11601.06
EXTENSION BRACKET NOT INCLUDED	
FRONT EXTENSION BRACKET	11602.09

See page 18 for even more Oversized Flares!!!



1 DASHPADS

DESCRIPTION	PART No.
"JEEP" MARKED DASHPAD FOR 1976-86 CJ, BLACK	DMC-5760458
"JEEP" MARKED DASHPAD FOR 1976-86 CJ, LIGHT GRAY (paintable)	DMC-5760459

2 STEEL DASH PANEL

DESCRIPTION	PART No.
1976-86 CJ STEEL DASH PANEL (cut out for glove box only)	13320.01

3 DASH LIGHTS

DESCRIPTION	PART No.
1976-86 CJ DASH INDICATOR LIGHT FULL KIT (6 PIECES)	13319.01
1976-86 CJ DASH INDICATOR LIGHT "LIGHTS"	13319.02
1976-86 CJ DASH INDICATOR LIGHT "WIPER WASHER"	13319.03
1976-86 CJ DASH INDICATOR LIGHT "AIR"	13319.04
1976-86 CJ DASH INDICATOR LIGHT "TEMP"	13319.05
1976-86 CJ DASH INDICATOR LIGHT "DEFROST"	13319.06
1976-86 CJ DASH INDICATOR LIGHT "FAN"	13319.07
1987-95 WRANGLER INSTRUMENT LIGHT SOCKET (NEW)	17237.04

4 PLASTIC REPLACEMENT GLOVE BOX INSERTS

DESCRIPTION	PART No.
1972-86 CJ	13316.01
1955-71 CJ	13316.02
1955-71 CJ, EXTRA LARGE	13316.03
1972-73 COMMANDO	13316.04
JEEPSTER, EARLY MODEL WAGON, PICK-UP	13316.05

5 GLOVE BOX DOORS

DESCRIPTION	PART No.
1972-86 CJ, STAINLESS	11125.01
1972-86 CJ, BLACK	11228.01

6 REPLACEMENT DASH ITEMS

DESCRIPTION	PART No.
1976-86 CJ INTERIOR WINDSHIELD BRACKET KNOB (each)	13318.01
1976-86 CJ WIPER PIVOT COVER PLASTIC (each)	13318.02
1976-86 CJ RADIO DELETE PANEL	13318.03
1976-86 CJ DELETE PANEL HDW (2 nuts, 2 washers)	13318.04
1968-86 CJ KNOB FOR HEATER & WIPER SWITCH (each)	13318.05
1973-86 CJ HEADLIGHT SWITCH KNOB W/ ROD	13318.06
1976-86 CJ TURN SIGNAL LEVER	13318.07
1976-86 CJ STEERING COLUMN COVER, BLACK PLASTIC (OE style)	13318.08
1972-86 CJ BOLT (Torx head) INSTRUMENT PANEL	17258.01
1955-86 CJ DASH GRAB BAR, STAINLESS	11123.01
1955-86 CJ DASH GRAB BAR, BLACK	11203.01
1987-95 WRANGLER BOLT (Torx head) INST PANEL	17258.01
1987-95 WRANGLER DASH GRAB BAR, BLACK	11203.01
1987-95 WRANGLER DASH GRAB BAR, STAINLESS	1123.01

7 REPLACEMENT SEAT BELTS FOR CJ & WRANGLER

DESCRIPTION	PART No.
1982-95 CJ & WRANGLER FRONT 3 POINT SHOULDER HARNESS	13202.01
1976-81 CJ FRONT RETRACTABLE LAP BELT	13202.02
6" BRACKET FOR 13202.01 & 13202.02, ADDS HEIGHT TO FEMALE END TO CLEAR CONSOLES & LARGE SEATS	13202.03
1941-75 CJ FRONT BELT, 60"	13202.04
1976-86 CJ REAR BELT, 60"	13202.04
1987-95 WRANGLER REAR BELT, 60" SEAT BELT HARNESS FLOOR MOUNT, ROUND WASHER WITH WELDED NUT	13202.05
SEAT BELT HARNESS FLOOR MOUNT, OVAL WASHER WITH WELDED NUT	13202.06
SEAT BELT RETRACTOR, LAP BELT	13202.07

8 INTERIOR REARVIEW MIRRORS

DESCRIPTION	PART No.
1941-45 WILLYS REAR VIEW MIRROR	11020.01
1948-75 CJ REAR VIEW MIRROR	11020.01
1972-86 CJ REAR VIEW MIRROR KIT INCLUDES MIRROR, BUTTON & GLUE	11020.02
1987-06 WRANGLER REAR VIEW MIRROR KIT INCLUDES MIRROR, BUTTON & GLUE	11020.02
MIRROR MOUNTING GLUE	11021.01

9 REPLACEMENT SUN VISORS

Replace those old, worn out or missing sun visors with these OE style replicas. Available in factory matching black, gray, charcoal or spice. Sold in pairs. Mounting screws not included.

DESCRIPTION	PART No.
1972-86 CJ BLACK VINYL	13301.01
1972-86 CJ GRAY VINYL	13301.09
1972-86 CJ CHARCOAL VINYL	13301.15
1972-86 CJ SPICE VINYL	13301.37
1987-95 WRANGLER BLACK VINYL	13312.01
1987-95 WRANGLER GRAY VINYL	13312.09
1987-95 WRANGLER CHARCOAL VINYL	13312.15
1987-95 WRANGLER SPICE VINYL	13312.37

10 CUP HOLDER

DESCRIPTION	PART No.
1984-96 CHEROKEE	12035.50

11 REPLACEMENT DOOR ITEMS

DESCRIPTION	PART No.
1976-86 CJ INTERIOR DOOR HANDLE	11801.01
1976-86 CJ HARD TOP DOOR WINDOW CRANK HANDLE	11814.01
1987-91 WRANGLER HARD TOP DOOR WINDOW CRANK HANDLE	11814.01

Body kits, body tubs and body parts are sold "As Is". See Limited Warranty Information inside back cover. Drilling, cutting and other modifications may be required for proper installation. Claims for freight damage must be placed with freight carriers.



WARNING
Restoration or replacement fuel tanks are direct replacements of original components and are not designed or warranted as meeting current safety standards (including FMVSS).

MB & GPW

1 STEEL BODY KITS

Kits include: Body Tub, Hood, 2 fenders and windshield frame. Top Bow and other body parts sold separately.

DESCRIPTION	PART No.
MINI-MB BODY KIT (includes top bow assy & seat frame)	12001.01
MB EARLY STEEL BODY KIT WITH SLAT GRILLE (1941 and early 1942)	12001.03
MB STEEL BODY KIT (March 1942 through December 1943)	12001.20
MB STANDARD STEEL BODY KIT (44-45)	12001.02
GPW STEEL BODY KIT	12001.04

2 STEEL BODY TUBS

DESCRIPTION	PART No.
MB STANDARD STEEL TUB ONLY	12002.01
MB EARLY STEEL TUB ONLY	12002.02
GPW STEEL TUB ONLY	12002.03

3 STEEL FENDERS & HOODS

DESCRIPTION	PART No.
MB, GPW HOOD	12003.01
MB, GPW HOOD HINGE	12021.01
MB, GPW HOOD CATCH KIT, USE ONE PER SIDE	12021.83
MB, GPW HOOD CATCH KIT, BLACK POWDERCOATED, USE ONE PER SIDE	11210.04
MB, GPW HOOD CATCH BRACKET	12021.77
MB, GPW HOOD WINDSHIELD CATCH, VERTICAL MOUNT, BLACK POWDERCOATED, USE ONE PER SIDE	11210.05
MB, GPW FRONT FENDER, DRIVER SIDE	12004.01
MB, GPW FRONT FENDER PASSENGER SIDE	12004.02
MB, FENDER BRACE, DRIVER SIDE (LH)	12021.03
MB, FENDER BRACE, PASSENGER SIDE (RH)	12021.02

4 BACK PANELS

DESCRIPTION	PART No.
*WILLYS® MARKED MB BACK PANEL	DMC-2758
MB, GPW BACK PANEL	12005.01

5 SEAT FRAMES & PARTS

DESCRIPTION	PART No.
MB, GPW DRIVER SEAT FRAME	12011.01
MB, GPW PASSENGER SEAT FRAME	12011.02
MB, GPW REAR SEAT FRAME	12011.03
AUTHENTIC GPW, REAR SEAT FRAME	12011.15
MB, GPW REAR SEAT TO WHEELHOUSE SUPPORT	12021.17
MB, GPW REAR SEAT PIVOT BRACKET	12021.18
MB, GPW REAR SEAT PIVOT RETAINER	12021.19
MB, GPW REAR SEAT HOOK	12021.20

MB BODY TUB

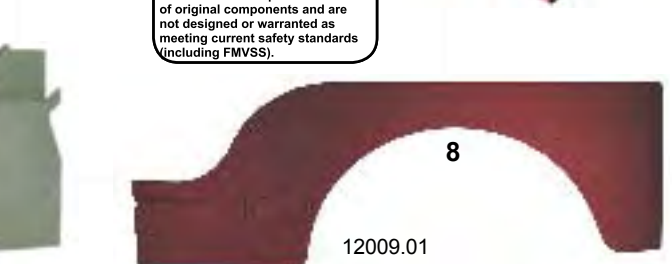

6 WINDSHIELD FRAME & PARTS

DESCRIPTION	PART No.
MB, GPW STEEL WINDSHIELD FRAME (inner & outer)	12006.01
MB, GPW WINDSHIELD CLAMP & HOOK (each side)	12021.04
MB, GPW COWL RUBBER	12302.01
MB, GPW INNER & OUTER WINDSHIELD SEAL	12301.01
MB, GPW GLASS SEAL (2 needed)	12301.02
MB, GPW WINDSHIELD ADJUSTER ARM	12021.05
MB, GPW WINDSHIELD ADJUSTER KNOB	12021.06
MB, GPW WINDSHIELD INNER FRAME	12021.07
MB, GPW WINDSHIELD HOOD REST WITHOUT CANVAS	12021.08
MB, GPW WINDSHIELD BRACKET TO COWL	12021.09
MB, GPW WINDSHIELD HOLD DOWN	12021.84
MB, GPW WINDSHIELD HOLD DOWN BRACKET	12021.10
MB, GPW WINDSHIELD CATCH	12021.78
MB, GPW WINDSHIELD HOLD DOWN & CATCH (NEW)	12021.94

7 TIRE CARRIERS

DESCRIPTION	PART No.
LATE MB, GPW SPARE TIRE CARRIER, 3 BOLT	12021.11
EARLY MB, GPW SPARE TIRE CARRIER, 2 BOLT	12021.12
EARLY MB SUPPORT BRACKET FOR 2 BOLT SPARE TIRE CARRIER	12021.13
EARLY MB PLATE FOR 2 BOLT SPARE TIRE CARRIER	12021.14

8 STEEL REPLACEMENT PANELS

DESCRIPTION	PART No.
MB, GPW FLOOR PANEL ASSEMBLY, FRONT	12007.01
MB, GPW FLOOR PANEL ASSEMBLY, REAR	12008.01
MB, GPW SIDE PANEL, DRIVER SIDE (with axe sheath)	12009.01
MB, GPW SIDE PANEL, PASSENGER SIDE	12009.02
MB, GPW SIDE COWL PANEL WITH STEP, DRIVER SIDE	12010.01
MB, GPW SIDE COWL PANEL WITH STEP, PASSENGER SIDE	12010.02
MB, GPW FRONT STEP ONLY, DRIVER SIDE	12021.15
MB, GPW FRONT STEP ONLY, PASSENGER SIDE	12021.16

9 BODY MOUNTING KIT

DESCRIPTION	PART No.
MB, GPW	12201.01

10 FUEL TANKS

DESCRIPTION	PART No.
EARLY MB GAS TANK, SMALL SPOUT	17720.01
LATE MB, GPW GAS TANK, BIG SPOUT	17720.02
EARLY MB GAS TANK WELL	12021.21
LATE MB, GPW GAS TANK WELL	12021.22
LATE MB, GPW FUEL CAP FOR BIG SPOUT TANK	17726.01
GAS TANK FELT KIT (NEW)	12021.87

Body kits, body tubs and body parts are sold "As Is". See Limited Warranty Information inside back cover. Drilling, cutting and other modifications may be required for proper installation. Claims for freight damage must be placed with freight carriers.



11550.01

1 CROSSMEMBERS & FRAME PARTS

DESCRIPTION	PART No.
MB, GPW TM/TC CROSSMEMBER	12021.23
MB, GPW REAR CROSSMEMBER	12021.24
MB CHASSIS FRAME RAIL (TIP), 18.5", LH	12021.31
MB CHASSIS FRAME RAIL (TIP), 18.5", RH	12021.32
MB CHASSIS FRONT FRAME RAIL, 49", LH (NEW)	12021.91
MB CHASSIS FRONT FRAME RAIL, 49", RH (NEW)	12021.92
MB, GPW SHOCK PLATE, REAR DRIVER SIDE	12021.53
MB, SHOCK PLATE, REAR PASSENGER SIDE	12021.52
MB, REAR FLOOR BRACKET SHORT	12021.55
MB, GPW REAR FLOOR BRACKET, LONG	12021.56
MB, CJ2A, CJ3A, CJ3B "V" FRAME BRACKET	12021.64
GPW (will not fit MB) BATTERY TRAY	12021.61
MB, GPW BATTERY HOLD DOWN	12021.85
MB, GPW BATTERY STRAP HOLD DOWN TO FENDER (NEW)	12021.93
MB, GPW BATTERY J-BOLT	12021.82

2 BUMPER PARTS:

DESCRIPTION	PART No.
MB, GPW REAR BUMPERETTE (each)	12021.25
MB, GPW FRONT BUMPER	12021.26
MB, FRONT BUMPER WOOD FILL	12021.69
GPW, FRONT BUMPER WOOD FILL	12021.70
MB, GPW BUMPER GUSSET, UPPER, DRIVER SIDE	12021.27
MB, GPW BUMPER GUSSET, UPPER, PASS. SIDE	12021.28
MB, GPW BUMPER GUSSET, LOWER, DRIVER SIDE	12021.29
MB, GPW BUMPER GUSSET, LOWER, PASS. SIDE	12021.30

3 HEADLIGHT & TAIL LAMP

DESCRIPTION	PART No.
MB, GPW, ASSEMBLY WITH LENS, LEFT	12403.51
MB, GPW, ASSEMBLY WITH LENS, RIGHT	12403.52
MB, GPW - HEADLIGHT BUCKET (WITHOUT LIGHT)	12402.05
MB, GPW - BLACKOUT LIGHT BUCKET	12021.80
MB, GPW TAIL LAMP BUCKET ASSY, RH=LH (without lens or bulb)	12403.50

4 MISCELLANEOUS MB & GPW PARTS

DESCRIPTION	PART No.
MB, GPW FOOTREST	12021.57
MB, GPW FOOTREST, GPW-STYLE	12021.81
MB, GPW AIR HORN	12021.58
MB, GPW AIR CLEANER TUBE & BRACKET	12021.59
MB, GPW MASTER CYLINDER COVER PLATE	12021.60
MB, FRONT AXLE, OIL SEAL (wheel end)	16526.04
MB, GPW BODY HANDLE, CORNER	12021.47
MB, GPW BODY HANDLE, SIDE	12021.48
MB, GPW BLACKOUT DRIVE LAMP BRACKET	12021.49
MB, GPW HEADLAMP BRACKET, RH	12021.50
MB, GPW HEADLAMP BRACKET, LH	12021.51
MB, GPW MIRROR ARM (NEW)	11001.10
MB, GPW RADIATOR & AIR DEFLECTOR FELT & STAPLER KIT (NEW)	12021.86
MB, GPW RADIATOR FELT KIT (NEW)	12021.86
MB, GPW FUEL TANK ANTI SQUEAK FELT KIT (NEW)	12021.87
MB, GPW TOOL COMPARTMENT FELT KIT (NEW)	12021.89

5 TOP BOW ASSEMBLIES

DESCRIPTION	PART No.
MB, GPW TOP BOW ASSEMBLY	12021.33
MB, GPW TOP BOW PIVOT BRACKET	12021.34
MB, GPW TOP BOW PIVOT	12021.35
MB, GPW TOP BOW PIVOT BRACKET FRONT PASSENGER SIDE	12021.36
MB, GPW TOP BOW PIVOT BRACKET FRONT DRIVER SIDE	12021.37

6 STORAGE BODY PARTS:

DESCRIPTION	PART No.
MB, GPW MACHINE MOUNTING PLATE	12021.54
MB, GPW JERRY CAN CARRIER (jerry can not included)	12021.62
MB, GPW JERRY CAN STRAP BRACKET	12021.79
MB, OIL CAN BRACKET	12021.63
MB, GPW AXE CLAMP, FRONT	12021.39
MB, GPW AXE CLAMP, REAR	12021.40
MB, GPW AXE SHEATH	12021.41
MB, GPW SHOVEL BRACKET	12021.42
MB, GPW FOOTMAN LOOP	12021.43
MB TOOL COMPARTMENT LID	12021.44
GPW TOOL COMPARTMENT LID	12021.45
MB, GPW TOOL BOX LOCK & KEY	12021.76
MB, GPW GLOVE COMPARTMENT LID	12021.46

7 PINTLE HOOK

DESCRIPTION	PART No.
PINTLE HOOK	11550.01

8 REPLACEMENT WHEEL

DESCRIPTION	PART No.
MB, GPW, M38 ONE-PIECE REPLACEMENT CIVILIAN STYLE WHEEL (16")	16725.01

9 REPLACEMENT COMBAT WHEEL

DESCRIPTION	PART No.
MB, SPLIT STYLE	16725.02

1948-53 M38 BODY PARTS

Body kits, body tubs and body parts are sold "As Is". See Limited Warranty Information inside back cover. Drilling, cutting and other modifications may be required for proper installation. Claims for freight damage must be placed with freight carriers.



1 STEEL BODY KITS

Kits include: Body Tub, Hood, 2 fenders and windshield frame. Top Bow and other body parts sold separately.

DESCRIPTION	PART No.
STEEL BODY KIT	12001.05
STEEL BODY TUB ONLY	12002.04
BODY MOUNTING KIT	12001.01

2 HOOD & TAILGATE

DESCRIPTION	PART No.
STEEL HOOD	12003.02
HOOD HINGE	12021.01
STEEL TAILGATE	12005.02

3 AUTHENTIC M38 STYLE FENDERS

DESCRIPTION	PART No.
STEEL FENDER, DRIVER SIDE	12004.03
STEEL FENDER, PASSENGER SIDE	12004.04

4 WINDSHIELD FRAME & PARTS

DESCRIPTION	PART No.
WINDSHIELD FRAME	12006.02
WINDSHIELD RIGHT PIVOT BRACKET	12023.02
WINDSHIELD LEFT PIVOT BRACKET	12023.01
WINDSHIELD FRAME PIVOT BOLT	12023.03
WINDSHIELD FRAME CLAMP & HOOK	12023.04
WINDSHIELD FRAME TO COWL RUBBER	12302.01
WINDSHIELD GLASS SEAL KIT	12301.03
WINDSHIELD FRAME HOOD REST	12023.05
WINDSHIELD FRAME VENTILATOR COVER	12023.06

5 SEAT FRAMES & PARTS

DESCRIPTION	PART No.
FRONT DRIVER SIDE SEAT FRAME	12011.05
FRONT PASSENGER SIDE SEAT FRAME	12011.06
REAR SEAT FRAME	12011.07
REAR SEAT WHEELHOUSE SUPPORT	12023.07
REAR SEAT PIVOT BRACKET	12023.08
REAR SEAT PIVOT RETAINER	12023.09
REAR SEAT SPRING RETAINER	12023.10

6 STEEL REPLACEMENT PANELS

DESCRIPTION	PART No.
FLOOR PANEL ASSEMBLY, FRONT	12007.02
FLOOR PANEL ASSEMBLY, REAR	12008.02
TOP COWL PLATE (NEW)	12023.47
SIDE COWL PANEL WITH STEP DRIVER SIDE	12010.03
SIDE COWL PANEL WITH STEP PASSENGER SIDE	12010.04
SMALL SIDE COWL STEP DRIVER SIDE	12021.15
SMALL SIDE COWL STEP PASSENGER SIDE	12021.16
SIDE PANEL, DRIVER SIDE	12009.03
SIDE PANEL, PASSENGER SIDE	12009.04
DOOR CHANNEL TO COWL DRIVER SIDE	12023.33
DOOR CHANNEL TO COWL PASSENGER SIDE	12023.32
DOOR SOCKET HINGE DRIVER SIDE	12023.35
DOOR SOCKET HINGE PASSENGER SIDE	12023.34
INSTRUMENT PANEL	12023.36
MASTER CYL ACCESS PLATE	12023.37
DRAIN HOLE COVER	12023.38
CENTER FRONT TRANSMISSION PANEL	12023.39



Body kits, body tubs and body parts are sold "As Is". See Limited Warranty Information inside back cover. Drilling, cutting and other modifications may be required for proper installation. Claims for freight damage must be placed with freight carriers.



WARNING
Restoration or replacement fuel tanks are direct replacements of original components and are not designed or warranted as meeting current safety standards (including FMVSS).

7 GAS TANK & PARTS

DESCRIPTION	PART No.
GAS TANK	17720.03
GAS TANK GROMMET	12023.11
GAS TANK FELT KIT (NEW)	12021.87

8 TOP BOW ASSEMBLY & PARTS

DESCRIPTION	PART No.
TOP BOW ASSEMBLY	12023.12
TOP BOW SOCKET	12023.13
REAR TOP BOW STORAGE BRACKET	12023.14
FRONT TOP BOW BRACKET	12023.15
REAR TOP BOW STORAGE BRACKET (NEW)	12023.45
CANVAS TOP RETAINER (NEW)	12023.46

9 REPLACEMENT WHEEL

DESCRIPTION	PART No.
M38, MB, GPW ONE-PIECE REPLACEMENT CIVILIAN STYLE WHEEL (16")	16725.01

10 SPARE TIRE CARRIER

DESCRIPTION	PART No.
SPARE TIRE CARRIER	12023.16
SPARE TIRE VIBRATION BUMPER	12023.17

11 CROSSMEMBERS & BUMPERS

DESCRIPTION	PART No.
TRANSMISSION/TRANSFER CASE CROSSMEMBER	12023.18
FRONT BUMPER	12023.19
REAR CROSSMEMBER	12023.20
REAR INTERMEDIATE CROSSMEMBER (NEW)	12023.48

12 STORAGE BODY PARTS

DESCRIPTION	PART No.
AXE CLAMP, FRONT	12023.24
AXE SHEATH	12023.25
SHOVEL BRACKET	12023.26
FOOTMAN LOOP, OLIVE GREEN	12023.27
FOOTMAN LOOP, SILVER FINISH	12023.28
RADIO RECEPTACLE BRACKET	12023.29
MACHINE HOLDER BRACKET	12023.31
FIRST AID KIT BRACKET	12023.40
GLOVE BOX DOOR ASSEMBLY	12023.41
TOOL COMPARTMENT LID	12023.42
JERRY CAN CARRIER (jerry can not included)	12021.62

13 MISCELLANEOUS BODY PARTS

DESCRIPTION	PART No.
HEADLIGHT GUARD	12023.21
GRILLE/TAILGATE HINGE	12023.22
BLACKOUT DRIVE LAMP BRACKET	12023.23
FUEL GUARD	12023.30
RADIATOR FELT KIT (NEW)	12021.86

14 WIPER MOTOR KITS KITS INCLUDE: MOTOR, ARM & BLADE

DESCRIPTION	PART No.
6V ELECTRIC WIPER KIT	19101.01
12V ELECTRIC WIPER KIT	19101.02
12V STAINLESS STEEL WIPER KIT	19101.03
24V WIPER KIT	19101.04
SPARE WIPER ARM AND BLADE (fits all above kits)	19102.01

Body kits, body tubs and body parts are sold "As Is". See Limited Warranty Information inside back cover. Drilling, cutting and other modifications may be required for proper installation. Claims for freight damage must be placed with freight carriers.



12001.07 1



12002.26 2



12011.10 4



12004.05 3



12004.06 3



12006.04 5



12011.08 4



DMC-3227K 6



12005.03 3



DMC-670969 6



DMC-663188 6



DMC-681798 6



1 STEEL BODY KITS

Kits include: Body Tub, Hood, 2 fenders and windshield frame. Top Bow and other body parts sold separately.

DESCRIPTION	PART No.
CJ2A	12001.07
CJ3A	12001.08
CJ3B	12001.09

2 STEEL BODY TUBS

DESCRIPTION	PART No.
CJ2A	12002.06
CJ3A	12002.07
CJ3B	12002.08

3 STEEL HOODS, FENDERS & TAILGATE

DESCRIPTION	PART No.
CJ2A & CJ3A HOOD	12003.01
CJ3B HOOD	12003.03
CJ2A, CJ3A, CJ3B HOOD HINGE	12021.01
CJ2A, CJ3A, CJ3B TAILGATE	12005.03
CJ2A, CJ3A, CJ3B TAILGATE HINGE (each side)	12025.01
CJ2A FRONT FENDER, DRIVER SIDE	12004.05
CJ2A FRONT FENDER, PASSENGER SIDE	12004.06
CJ3A, CJ3B FRONT FENDER, DRIVER SIDE	12004.03
CJ3A, CJ3B FRONT FENDER, PASSENGER SIDE	12004.04

4 SEAT FRAMES

DESCRIPTION	PART No.
CJ2A REAR SEAT FRAME	12011.08
CJ2A FRONT DRIVER SEAT FRAME	12011.09
CJ2A FRONT PS SEAT FRAME	12011.10
CJ2A, CJ3A, CJ3B UNDERSEAT TOOL COMPARTMENT WITH LID	12025.10
CJ3A REAR SEAT FRAME	12011.12
CJ3A FRONT SEAT FRAME, DRIVER	12011.13
CJ3A FRONT SEAT FRAME, PASSENGER	12011.14

5 WINDSHIELD FRAMES & PARTS

DESCRIPTION	PART No.
CJ2A (inner & outer) WINDSHIELD FRAME	12006.03
CJ3A WINDSHIELD FRAME	12006.04
CJ3B WINDSHIELD FRAME	12006.05
CJ2A, CJ3A, CJ3B WINDSHIELD COWL RUBBER SEAL	12302.01
CJ2A WINDSHIELD INNER-OUTER WEATHERSTRIP	12301.01
CJ2A WINDSHIELD GLASS SEAL (2 needed)	12301.02
CJ3A, CJ3B WINDSHIELD GLASS WEATHERSTRIP	12301.03
CJ2A INNER WINDSHIELD FRAME	12025.03
CJ2A CENTER WINDSHIELD FRAME LATCH	12025.04
CJ2A WINDSHIELD ADJUSTING ARM KIT LEFT	12025.05
CJ2A WINDSHIELD ADJUSTING ARM KIT RIGHT	12025.06
CJ2A WINDSHIELD ADJUSTING ARM SPARE T-BOLT	12025.07
CJ3A WINDSHIELD VENTILATION COVER & HANDLE KIT	12025.08
CJ3A WINDSHIELD VENT HANDLE KIT W/O COVER	12025.09
CJ2A, CJ3A, CJ3B WINDSHIELD CLAMP KIT (each side)	12021.04
CJ2A, CJ3A, CJ3B WINDSHIELD PIVOT BRACKET LH	12023.01
CJ2A, CJ3A, CJ3B WINDSHIELD PIVOT BRACKET RH	12023.02
CJ2A, CJ3A, CJ3B WINDSHIELD TIE DOWN STRAP (NEW)	11825.20

6 LICENSED RESTORATION ITEMS

DESCRIPTION	PART No.
"WILLYS"® MARKED BODY KIT: FOR 46-49 CJ2A (NEW)	DMC-673859-2A
"WILLYS"® MARKED BODY KIT: FOR 48-53 CJ3A (NEW)	DMC-673859-3A
"WILLYS"® MARKED BODY KIT: FOR 53-64 CJ3B (NEW)	DMC-693197
"WILLYS"® MARKED HOOD: FOR 1946-53 CJ2A, CJ3A	DMC-670969
"WILLYS"® MARKED HOOD: FOR 1953-64 CJ3B	DMC-681334
"WILLYS"® MARKED TAILGATE: FOR 1946-68 CJ2A, CJ3A/3B	DMC-663188
"JEEP"® MARKED TOOLBOX: FOR 1946-75 CJs	DMC-3227K
GRILLE, CJ2A, EARLY, 1945-46	DMC-663536
GRILLE, CJ2A, LATE, 1947-49	DMC-668124
GRILLE, CJ3A, 1949-53	DMC-673149
GRILLE, CJ3B, 1953-64 WITH "WILLYS"® MARK	DMC-681798

Body kits, body tubs and body parts are sold "As Is". See Limited Warranty Information inside back cover. Drilling, cutting and other modifications may be required for proper installation. Claims for freight damage must be placed with freight carriers.

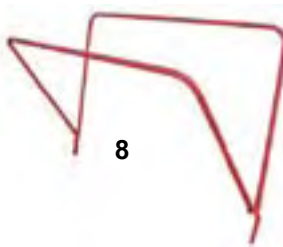

WARNING
Restoration or replacement fuel tanks are direct replacements of original components and are not designed or warranted as meeting current safety standards (including FMVSS).

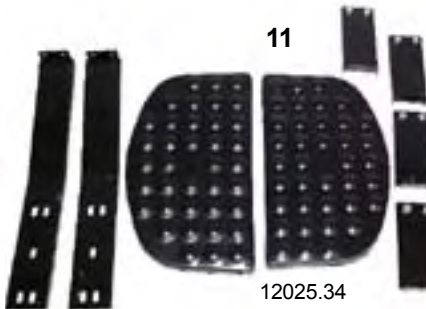

7 STEEL REPLACEMENT BODY PANELS

DESCRIPTION	PART No.
CJ2A, CJ3A REAR CENTER FLOOR PANEL	12008.03
CJ2A, CJ3A FRONT FLOOR PANEL	12007.03
CJ2A, CJ3A TOP COWL PLATE	12025.11
CJ2A, CJ3A SIDE BODY PANEL DRIVER SIDE	12009.05
CJ2A, CJ3A SIDE BODY PANEL PASSENGER SIDE	12009.06
CJ2A, CJ3A SIDE COWL PANEL DRIVER SIDE	12010.05
CJ2A, CJ3A SIDE COWL PANEL PASSENGER SIDE	12010.06
CJ2A, CJ3A, CJ3B SIDE COWL STEP ONLY DRIVER SIDE	12021.15
CJ2A, CJ3A, CJ3B SIDE COWL STEP ONLY PASS SIDE	12021.16
CJ2A, CJ3A DASHBOARD PLATE	12025.15
CJ2A, CJ3A FIREWALL PLATE	12025.16
CJ2A, CJ3A PANEL TAIL LIGHT DRIVER SIDE	12025.17
CJ2A, CJ3A PANEL TAIL LIGHT PASSENGER SIDE	12025.18
CJ2A WHEEL GUARD LOWER DRIVER SIDE	12025.43
CJ2A WHEEL GUARD LOWER PASSENGER SIDE	12025.44
CJ2A WHEEL GUARD UPPER DRIVER SIDE	12025.41
CJ2A WHEEL GUARD UPPER PASSENGER SIDE	12025.42
CJ3A WHEEL GUARD UPPER DRIVER SIDE	12025.19
CJ3A WHEEL GUARD UPPER PASSENGER SIDE	12025.20
CJ3A WHEEL GUARD LOWER DRIVER SIDE	12025.21
CJ3A WHEEL GUARD LOWER PASSENGER SIDE	12025.22

8 TOP BOWS

DESCRIPTION	PART No.
CJ2A, FRONT, LH, BRACKET ASSEMBLY	12025.35
CJ2A, FRONT, RH, BRACKET ASSEMBLY	12025.36
CJ2A, FRONT STORAGE BRACKET ASSEMBLY	12025.37
CJ2A, REAR, RH BRACKET ASSEMBLY	12025.38
CJ2A, REAR, LH BRACKET ASSEMBLY	12025.39
CJ2A, REAR STORAGE BRACKET ASSEMBLY	12025.40

9 FUEL TANK & PARTS

DESCRIPTION	PART No.
CJ2A, CJ3A & EARLY CJ3B STEEL GAS TANK	17720.04
LATE 3B STEEL GAS TANK	17720.05
CJ2A, CJ3A & EARLY CJ3B POLYETHYLENE GAS TANK	17722.01
LATE 3B POLYETHYLENE GAS TANK	17722.03
CJ2A, CJ3A, CJ3B GAS TANK GROMMET	12025.23
CJ2A, CJ3A, CJ3B GAS TANK STRAP KIT	12025.24
CJ2A, CJ3A, CJ3B FUEL NECK HOUSING	12025.25
GAS TANK FELT KIT (NEW)	12021.87

10 WIPER MOTOR KITS

DESCRIPTION	PART No.
CJ2A, CJ3A, CJ3B 6V ELECTRIC WIPER KIT	19101.01
CJ2A, CJ3A, CJ3B 12V ELECTRIC WIPER KIT	19101.02
CJ2A, CJ3A, CJ3B 12V STAINLESS STEEL WIPER KIT	19101.03
CJ2A, CJ3A, CJ3B SPARE WIPER ARM & BLADE (fits all above kits)	19102.01

11 MISCELLANEOUS PARTS

DESCRIPTION	PART No.
CJ2A WIPER TUBE SET	12025.33
CJ2A, CJ3A AIR HORN, L-HEAD	12021.58
CJ2A, CJ3A AIR CLEANER TUBE & BRACKET	12025.30
CJ2A, CJ3A CHROME HEADLIGHT BEZEL (each)	12419.01
CJ2A, CJ3A, CJ3B (CJ5 style) SIDE STEP, PAIR	12025.34
CJ2A, CJ3A, CJ3B SPARE TIRE CARRIER	12025.27
CJ2A, CJ3A, CJ3B BODY OUTRIGGER, LEFT OR RIGHT	12025.31
CJ2A, CJ3A, CJ3B FOOTMAN LOOP, SILVER FINISH	12023.28
CJ2A, CJ3A, CJ3B REAR FLOOR "L" BRACKET	12021.55
CJ2A, CJ3A, CJ3B JERRY CAN CARRIER (can not incl)	12021.62
CJ2A, CJ3A, CJ3B "V" FRAME BRACKET	12021.64
CJ3B CHROME HEADLIGHT BEZEL (each)	12419.02
CJ3B AIR HORN, F-HEAD	12025.29
PINTLE HOOK	11550.01
TOOL COMPARTMENT LID	12023.42
CJ2A RADIATOR FELT KIT (NEW)	12021.86
CJ2A FUEL TANK ANTI SQUEAK FELT KIT (NEW)	12021.87

12 REPLACEMENT STEEL WHEEL

DESCRIPTION	PART No.
CJ-2A, 3A, 3B ONE-PIECE REPLACEMENT CIVILIAN STYLE WHEEL, (16")	16725.01



Body kits, body tubs and body parts are sold "As Is". See Limited Warranty Information inside back cover. Drilling, cutting and other modifications may be required for proper installation. Claims for freight damage must be placed with freight carriers.



12002.09



12217.01

4



12201.01



OMIX-ADA®



12001.19



12003.05

5



12004.07

6



11601.01

7

1 STEEL BODY KITS

Kits include: Body Tub, Hood, 2 fenders and windshield frame. Top Bow and other body parts sold separately.

DESCRIPTION	PART No.
1952-68 M38A1 (some modifications necessary)	12001.15
1955-68 CJ5 (fenders without sidemark indents)	12001.10
1969 CJ5 (fenders with sidemark indents)	12001.11
1970-71 CJ5 (fenders with sidemark indents)	12001.12
1972-75 CJ5 (fenders with sidemark indents)	12001.13
1955-71 CJ6 (fenders without sidemark indents)	12001.14
1969-71 CJ6 STEEL BODY KIT (NEW)	12001.19

2 STEEL BODY TUBS

DESCRIPTION	PART No.
1955-69 CJ5 SIDE GAS FILL, NO COWL VENT	12002.09
1970-71 CJ5 NO SIDE GAS FILL, NO COWL VENT	12002.10
1972-75 CJ5 NO SIDE GAS FILL, HAS COWL VENT	12002.11
1955-71 CJ6 NO SIDE GAS FILL, HAS COWL VENT	12002.12

3 BODY MOUNTING KIT

DESCRIPTION	PART No.
CJ2A, CJ3A, CJ3B, CJ5, CJ6, M38A1	12201.01

4 STAINLESS STEEL BODY FASTENER KITS

DESCRIPTION	PART No.
1955-71 CJ5 & CJ6, 405 PIECES	12215.01
1972-75 CJ5 & CJ6 WITH TAILGATE, 539 PIECES	12215.02
1972-75 CJ5 WITHOUT TAILGATE, 456 PIECES	12215.03
1972-75 CJ5 2" BODY MOUNTING WASHER, 8 PIECES	12217.01

5 STEEL HOODS

DESCRIPTION	PART No.
1955-71 CJ5, CJ6, M38A1 STEEL HOOD	12003.04
1972-75 CJ5 STEEL HOOD	12003.05
1972-75 GRILLE TO HOOD GROMMET (4 needed)	12029.01

6 STEEL FENDERS

DESCRIPTION	PART No.
1953-68 CJ5, CJ6 FENDER, DRIVER SIDE WITHOUT SIDEMARKER INDENT	12004.07
1953-68 CJ5, CJ6 FENDER, PASSENGER SIDE WITHOUT SIDEMARKER INDENT	12004.08
1969-71 CJ5, CJ6 FENDER, DRIVER WITH SIDEMARK INDENT	12004.09
1969-71 CJ5, CJ6 FENDER, PASSENGER WITH SIDEMARK INDENT	12004.10
1972-75 CJ5, CJ6 FENDER, DRIVER SIDE	12004.11
1972-75 CJ5, CJ6 FENDER, PASSENGER SIDE	12004.12

7 FENDER FLARES

DESCRIPTION	PART No.
CJ5 4 PCS FENDER FLARE KIT WITH HARDWARE	11601.01
CJ5, CJ6 FRONT FENDER FLARE, DRIVER SIDE	11601.03
CJ5, CJ6 FRONT FENDER FLARE, PASSENGER SIDE	11601.02
CJ5 REAR FENDER FLARE, DRIVER SIDE	11601.05
CJ5 REAR FENDER FLARE, PASSENGER SIDE	11601.04
SPARE HARDWARE KIT FOR FENDER FLARES	11601.06

Body kits, body tubs and body parts are sold "As Is". See Limited Warranty Information inside back cover. Drilling, cutting and other modifications may be required for proper installation. Claims for freight damage must be placed with freight carriers.



12005.03



DMC-3227K

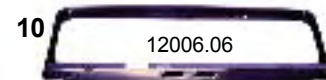

12006.06



12007.04



AUTHENTIC RESTORATION

12027.01



12029.03

11



DMC-5752656

9



AUTHENTIC RESTORATION



12008.04

12



16725.01

13



19101.03

14



12025.34

12

8 STEEL TAILGATES

DESCRIPTION	PART No.
1953-68 M38A1 REAR TAILGATE PANEL	12005.04
1955-75 CJ5, CJ6 STEEL TAILGATE	12005.03
1955-75 CJ5, CJ6 TAILGATE HINGE, EACH (2 needed)	12025.01

9 LICENSED RESTORATION ITEMS

DESCRIPTION	PART No.
"JEEP®" MARKED BODY TUB: FOR 1955-69 CJ5	DMC-680637
"JEEP®" MARKED BODY TUB: FOR 1970-71 CJ5	DMC-680637-VC
"JEEP®" MARKED BODY TUB: FOR 1972-75 CJ5	DMC-680637-VD
"JEEP®" MARKED TAILGATE: FOR 1969-83 CJ5	DMC-685459
"JEEP®" MARKED TOOLBOX: FOR 1946-75 CJ'S	DMC-3227K
GRILLE FOR 1955-71 CJ5, CJ6	DMC-815385
GRILLE FOR 1972-86 CJ5, CJ7, CJ8	DMC-5752656

10 WINDSHIELD FRAMES & PARTS

DESCRIPTION	PART No.
1955-68 CJ5, CJ6 WINDSHIELD FRAME, TOP WIPERS	12006.06
1969-75 CJ5, CJ6 WINDSHIELD FRAME, BOTTOM WIPERS	12006.07
1955-75 CJ5, CJ6 COWL RUBBER SEAL	12302.02
1951-75 M38-A1, CJ5, CJ6 WINDSHIELD GLASS SEAL	12301.03
WINDSHIELD TIE DOWN STRAP (NEW)	11825.20
1953-75 M38-A1, CJ5, CJ6 UPPER WINDSHIELD HINGE, LH (NEW)	12027.03
1953-75 M38-A1, CJ5, CJ6 UPPER WINDSHIELD HINGE, RH (NEW)	12027.04
1953-75 M38-A1, CJ5, CJ6 LOWER WINDSHIELD HINGE, LH (NEW)	12027.05
1953-75 M38-A1, CJ5, CJ6 LOWER WINDSHIELD HINGE, RH (NEW)	12027.06
1953-75 M38-A1, CJ5, CJ6 4-PIECE UPPER & LOWER WINDSHIELD HINGE SET (NEW)	12027.07

11 BUMPERS & CROSSMEMBERS

DESCRIPTION	PART No.
1955-75 CJ5, CJ6, CJ7, CJ8 FRONT BUMPER OE STYLE	12029.03
1955-75 CJ REAR CROSSMEMBER	12027.01

12 REPLACEMENT PANELS & MISC. PARTS

DESCRIPTION	PART No.
1955-75 CJ5 FRONT FLOOR PANEL	12007.04
1955-75 CJ5 REAR FLOOR PANEL	12008.04
1955-71 CJ5, CJ6 TOOL COMPARTMENT WITH LID	12025.10
1955-71 CJ5, CJ6 CENTER FRONT TRANSMISSION PANEL	12027.02
1955-71 CJ5, CJ6 SIDE STEP, PAIR	12025.34
1955-71 CJ5, CJ6 SPARE TIRE CARRIER	12025.27
1955-71 CJ5, CJ6 FUEL NECK HOUSING	12025.25
1955-75 CJ5, CJ6, M38A1 JERRY CAN CARRIER (jerry can not included)	12021.62
PINTLE HOOK	11550.01
TOOL COMPARTMENT LID	12023.42

13 REPLACEMENT WHEEL

DESCRIPTION	PART No.
1955-75 CJ5, CJ6 ONE-PIECE REPLACEMENT CIVILIAN STYLE WHEEL, (16")	16725.01

14 WIPER MOTOR KITS

DESCRIPTION	PART No.
1955-67 CJ 6V ELECTRIC WIPER KIT	19101.01
1955-67 CJ 12V ELECTRIC WIPER KIT	19101.02
1955-67 CJ 12V STAINLESS STEEL WIPER KIT	19101.03
1955-67 CJ SPARE WIPER ARM & BLADE (fits all above kits)	19102.01

Body kits, body tubs and body parts are sold "As Is". See Limited Warranty Information inside back cover. Drilling, cutting and other modifications may be required for proper installation. Claims for freight damage must be placed with freight carriers.



1 STEEL BODY KITS

Kits include: Body Tub, Hood, 2 fenders and windshield frame. Top Bow and other body parts sold separately.

DESCRIPTION	PART No.
1976-83 CJ-5	12001.16
1976-86 CJ-7	12001.17
1981-86 CJ-8	12001.18

2 STEEL BODY TUBS

DESCRIPTION	PART No.
1976-83 CJ-5	12002.13
1976-86 CJ-7	12002.14
1981-86 CJ-8	12002.15

3 LICENSED RESTORATION ITEMS

DESCRIPTION	PART No.
"JEEP" MARKED BODY TUB, FOR 1976-83 CJ5	DMC-5461335
"JEEP" MARKED BODY TUB, FOR 1976-86 CJ7	DMC-5464362
GRILLE, FOR 1972-86 CJ5, CJ7, CJ8	DMC-5752656
"JEEP" MARKED T TAILGATE, FOR 1969-83 CJ5	DMC-685459
"JEEP" MARKED TAILGATE, FOR 1976-86 CJ7	DMC-5454025
"JEEP" MARKED DASHPAD, FOR 1976-86 CJ, BLACK	DMC-5760458
"JEEP" MARKED DASHPAD, FOR 1976-86 CJ LIGHT GRAY PAINTABLE	DMC-5760459
1976-86 CJ SCREW FOR DASHPAD (8 needed)	12029.31
1976-86 CJ SCREW KIT DASHPAD (Total 8 pieces)	12029.32

4 STAINLESS STEEL BODY FASTENER KITS

DESCRIPTION	PART No.
1976-83 CJ5 (models with tailgate), 624 PIECES	12215.04
1976-83 CJ5 (models without tailgate), 592 PIECES	12215.05
1976-86 CJ7 WITH HARDTOP, 785 PIECES	12215.06
1976-86 CJ7 WITH SOFT TOP, 620 PIECES	12215.07
1981-86 CJ8 WITH HARDTOP, 714 PIECES	12215.09
1981-86 CJ8 WITH SOFT TOP, 640 PIECES	12215.10

5 BODY MOUNTING KIT

DESCRIPTION	PART No.
1976-86 CJ-5, CJ-7, CJ-8 *	12201.02
1976-86 CJ-7 FIBERGLASS BODIES ONLY *	12201.03

* Does not include hardware

6 STEEL HOODS, TAILGATES & PARTS

DESCRIPTION	PART No.
1976-86 CJ5, CJ7, CJ8 STEEL HOOD	12003.05
1976-95 CJ & WRANGLER BOLT HINGE TO HOOD, FENDER TO COWL, FENDER TO GRILLE	12029.30
1976-86 CJ GRILL TO HOOD GROMMET (4 needed)	12029.01
1976-83 CJ5 STEEL TAILGATE	12005.03
1976-83 CJ5 TAILGATE HINGE, EACH	12023.22
1976-86 CJ7, CJ8 STEEL TAILGATE	12005.05
1976-86 CJ7 & CJ8 TAILGATE CABLE (2 needed)	12029.02
TAILGATE LATCH BRACKET, CJ7 & CJ8	12029.25
1976-86 CJ7 & CJ8, LATCH BRACKET KIT (one side) (includes bolt & wave washers)	12029.26
1976-86 CJ7 & CJ8 BRACKET KIT (pair) (includes bolt & wave washers)	12029.27
1976-86 CJ7 & CJ8 BOLT FOR TAILGATE LATCH	12029.28
1976-86 CJ7 & CJ8 WAVE WASHER FOR TAILGATE LATCH	12029.29
1977-86 CAM & CABLE, CJ7 HARDTOP	11901.03
1977-86 LATCH ASSEMBLY, CJ7 HARDTOP, EACH	11901.04

7 BUMPERS & CROSSMEMBERS

DESCRIPTION	PART No.
1955-86 CJ5, CJ6, CJ7 & CJ8 FRONT BUMPER (OE style)	12029.03
1976-86 CJ5, CJ7, CJ8 REAR CROSSMEMBER	12029.04
1976-86 CJ BUMPERETTES PAIR, BLACK	11215.01

Body kits, body tubs and body parts are sold "As Is". See Limited Warranty Information inside back cover. Drilling, cutting and other modifications may be required for proper installation. Claims for freight damage must be placed with freight carriers.



8 WINDSHIELD FRAME & PARTS

DESCRIPTION	PART No.
1976-86 CJ5, CJ7, CJ8 STEEL WINDSHIELD FRAME	12006.08
1976-86 CJ5, CJ7, CJ8 WINDSHIELD GLASS SEAL	12301.04
1976-95 CJ WINDSHIELD HINGE SCREW (16 Required)	12029.06
1976-86 CJ5, CJ7, CJ8 WINDSHIELD HINGE SET BARE METAL, LEFT & RIGHT SET	12029.07
1976-86 CJ5, CJ7, CJ8 WINDSHIELD HINGE BARE METAL, LEFT ONLY	12029.09
1976-86 CJ5, CJ7, CJ8 WINDSHIELD HINGE BARE METAL, RIGHT ONLY	12029.08
1976-86 CJ5, CJ7, CJ8 COWL RUBBER SEAL	12302.03
1976-86 CJ5, CJ7, CJ8 WIPER PIVOT COVER	13318.01
1976-86 CJ5, CJ7, CJ8 WIPER MOTOR COVER, BLACK	19135.01
1976-86 CJ WINDSHIELD GLASS	12029.10
WINDSHIELD TIE DOWN STRAP (NEW)	11825.20

9 REPLACEMENT SIDE PANELS

DESCRIPTION	PART No.
1976-83 CJ5 SIDE PANEL DRIVER SIDE	12009.07
1976-83 CJ5 SIDE PANEL PASSENGER SIDE	12009.08
1976-86 CJ7 SIDE PANEL, DRIVER SIDE	12009.09
1976-86 CJ7 SIDE PANEL PASSENGER SIDE	12009.10
1981-86 CJ8, FRONT PORTION OF SIDE PANEL DRIVER SIDE	12009.11
1981-86 CJ8, REAR PORTION OF SIDE PANEL DRIVER SIDE	12009.13
1981-86 CJ8, FRONT PORTION OF SIDE PANEL PASSENGER SIDE	12009.12
1981-86 CJ8, REAR PORTION OF SIDE PANEL PASSENGER SIDE	12009.14

10 FENDER FLARES

DESCRIPTION	PART No.
1976-86 CJ5, CJ6, CJ7 4-PIECES FENDER FLARE KIT INCLUDES ALL NECESSARY HARDWARE	11601.01
1976-86 CJ5, CJ6, CJ7, CJ8 FRONT FENDER FLARE DRIVER SIDE	11601.03
1976-86 CJ5, CJ6, CJ7, CJ8 FRONT FENDER FLARE PASSENGER SIDE	11601.02
1976-86 CJ5, CJ6, CJ7 REAR FENDER FLARE DRIVER SIDE	11601.05
1976-86 CJ5, CJ6, CJ7 REAR FENDER FLARE PASSENGER SIDE	11601.04
1976-95 CJ & WRANGLER SPARE HARDWARE KIT	11601.06

11 FENDERS

DESCRIPTION	PART No.
1976-86 CJ5, CJ6, CJ7, CJ8 STEEL FENDER DRIVER SIDE	12004.11
1976-86 CJ5, CJ6, CJ7, CJ8 STEEL FENDER PASSENGER SIDE	12004.12

12 REPLACEMENT TAIL LIGHT PANELS

DESCRIPTION	PART No.
1976-83 CJ5 TAIL LIGHT PANEL, DRIVER SIDE	12029.11
1976-83 CJ5 TAIL LIGHT PANEL, PASSENGER SIDE	12029.12
1976-86 CJ7 TAIL LIGHT PANEL, DRIVER SIDE	12029.13
1981-86 CJ8 LEFT REAR WHEEL HOUSING (NEW)	12029.33
1981-86 CJ8 RIGHT REAR WHEEL HOUSING (NEW)	12029.34
1976-86 CJ7 TAIL LIGHT PANEL, PASSENGER SIDE	12029.14

13 REPLACEMENT FLOOR PANELS

DESCRIPTION	PART No.
1976-83 CJ5 FRONT FLOOR PANEL	12007.05
1976-83 CJ5 REAR FLOOR PANEL	12008.05
1976-86 CJ7, CJ8 FRONT FLOOR PANEL	12007.06
1976-86 CJ7 REAR FLOOR PANEL	12008.06

14 MISCELLANEOUS REPLACEMENT PANELS

DESCRIPTION	PART No.
1976-86 CJ5, CJ7 & CJ8 DASHBOARD PLATE	13320.01
1976-86 CJ5, CJ7 & CJ8 FIREWALL PLATE	12029.18
1976-86 CJ6, CJ7 & CJ8 TOP COWL PLATE	12029.17
1976-86 CJ7 REAR WHEEL HOUSING PASS SIDE	12029.16
1976-86 CJ7 REAR WHEEL HOUSING DRIVER SIDE	12029.15
1981-86 CJ8 REAR HOUSING CORNER PASS SIDE (NEW)	12029.33
1981-86 CJ8 REAR HOUSING CORNER DRIVER SIDE (NEW)	12029.34
1976-86 CJ GLOVE BOX LOCK, LATCH BRACKET	13317.01
1976-86 CJ GLOVE BOX BUTTON	11813.11

15 MISCELLANEOUS SEALS & PLUGS

DESCRIPTION	PART No.
1976-86 CJ 1" FLOOR PLUGS (each)	12029.19
1977-86 CJ7 LIFTGATE OUTER SEAL W/ PLASTIC LOCKS	12304.01
1977-86 CJ7 LIFTGATE INNER GLASS SEAL	12304.02
1976-86 CJ DOOR WEATHER SEAL PASSENGER	12303.02
1976-86 CJ DOOR WEATHER SEAL DRIVER SIDE	12303.01
1976-86 CJ7 & CJ8 TAILGATE SEAL	12305.01

Body kits, body tubs and body parts are sold "As Is". See Limited Warranty Information inside back cover. Drilling, cutting and other modifications may be required for proper installation. Claims for freight damage must be placed with freight carriers.



12005.06

1 REPLACEMENT STEEL FENDERS

DESCRIPTION	PART No.
1987-95 WRANGLER DRIVER SIDE	12004.13
1987-95 WRANGLER PASSENGER SIDE	12004.14
1997-06 WRANGLER & UNLIMITED DRIVER SIDE	12004.15
1997-06 WRANGLER & UNLIMITED PASSENGER SIDE	12004.16
2007-10 WRANGLER & UNLIMITED DRIVER SIDE (NEW)	12040.02
2007-10 WRANGLER & UNLIMITED PASSENGER SIDE (NEW)	12040.03

6 WINDSHIELD FRAMES & PARTS

DESCRIPTION	PART No.
1987-95 WRANGLER	12006.09
1997-02 WRANGLER	12006.10
2003-06 WRANGLER	12006.11
1976-95 CJ & WRANGLER WINDSHIELD HINGE	
SCREW (16 Required)	12029.06
WINDSHIELD TIE DOWN STRAP (NEW)	11825.20

2 REPLACEMENT HOOD PARTS

DESCRIPTION	PART No.
1987-95 WRANGLER STEEL HOOD	12003.06
1998-00 WRANGLER (to 02/07/00) HOOD WITH DUAL SPRAY NOZZLE HOLES	12003.07
2000-06 WRANGLER & UNLIMITED (from 02/07/00) HOOD WITH SINGLE SPRAY NOZZLE HOLE	12003.08
1987-95 WRANGLER HOOD GROMMET GRILLE TO HOOD (2 needed)	12031.01
1976-95 CJ & WRANGLER BOLT, HINGE TO HOOD	
FENDER TO COWL, FENDER TO GRILLE	12029.30
1987-06 WRANGLER & UNLIMITED HOOD TO FENDER GROMMET	12031.02
2007-10 WRANGLER & UNLIMITED STEEL HOOD (NEW)	12040.01

7 1987-95 WRANGLER FLARES & PARTS

DESCRIPTION	PART No.
FLARE KIT: INCLUDES 4 FLARES, 2 EXTENSIONS, BRACKETS & HARDWARE KIT	11602.01
FLARE KIT (4 pieces) INCLUDES: 4 FLARES & HARDWARE KIT	11602.02
FLARE-FRONT DRIVER SIDE	11602.03
FLARE-FRONT PASSENGER SIDE	11602.04
FLARE-REAR DRIVER SIDE	11602.05
FLARE-REAR PASSENGER SIDE	11602.06
FRONT EXTENSION DRIVER SIDE	11602.07
FRONT EXTENSION PASSENGER SIDE	11602.08
HARDWARE KIT (plastic locks & screws)	
EXTENSION BRACKET NOT INCLUDED	11601.06
FRONT EXTENSION BRACKET	11602.09

3 BODY PANELS

DESCRIPTION	PART No.
1987-96 WRANGLER SIDE PANEL DRIVER SIDE	12009.09
1987-96 WRANGLER SIDE PANEL PASSENGER SIDE	12009.10
1987-96 WRANGLER REAR WHEEL HOUSING PASSENGER SIDE	12029.16
1987-96 WRANGLER REAR WHEEL HOUSING DRIVER SIDE	12029.15

8 1997-06 FENDER FLARES & PARTS

DESCRIPTION	PART No.
1997-06 WRANGLER FLARE KIT (6 pieces) INCLUDES 4 FLARES, EXTENSIONS & HARDWARE	11603.01
1997-06 WRANGLER FLARE KIT (4 pieces) FLARES ONLY	
HARDWARE NOT INCLUDED	11603.02
1997-06 WRANGLER & UNLIMITED FLARE-FRONT PASSENGER SIDE	11603.04
1997-06 WRANGLER & UNLIMITED FLARE-FRONT DRIVER SIDE	11603.03
1997-06 WRANGLER FLARE-REAR PASSENGER SIDE	11603.06
1997-06 WRANGLER FLARE-REAR DRIVER SIDE	11603.05
1997-06 WRANGLER & UNLIMITED FLARE EXTENSION PASSENGER SIDE	11603.08
1997-06 WRANGLER & UNLIMITED FLARE EXTENSION DRIVER SIDE	11603.07
1997-06 WRANGLER HARDWARE KIT	11603.09

4 CHROME GRILLE COVER

DESCRIPTION	PART No.
1987-95 WRANGLER (genuine MOPAR brand)	12033.06
1997-06 WRANGLER & UNLIMITED (genuine MOPAR brand)	12033.01
2007-10 WRANGLER & UNLIMITED (genuine MOPAR brand)	12033.05

9 SPREADER BARS

DESCRIPTION	PART No.
1987-95 WRANGLER, FACTORY STYLE (each)	11251.01
1987-95 WRANGLER, ADJUSTABLE (pair)	11251.02

5 STEEL TAILGATES

DESCRIPTION	PART No.
1987-95 WRANGLER	12005.06
1997-06 WRANGLER & UNLIMITED	12005.07

Body kits, body tubs and body parts are sold "As Is". See Limited Warranty Information inside back cover. Drilling, cutting and other modifications may be required for proper installation. Claims for freight damage must be placed with freight carriers.



1 Rugged Ridge 7" FENDER FLARES & KITS

Improve your vehicles aggressive, rugged looks with Rugged Ridge's 7" Fender Flares. Not just for looks - these durable thermoplastic flares also provide added protection from road debris and stone chips

DESCRIPTION	PART No.
7" FLARE, 1987-95 WRANGLER KIT: 6 PIECES WITH HARDWARE	11607.01
7" FLARE, 1997-06 WRANGLER KIT: 6 PIECES	11608.01
Fender Flare Kit w/ Hardware, 1997-2006 Wrangler/Unlimited	11630.10
Fender Flare Kit w/ Hardware, 1987-95 Wrangler*	11632.10
Fender Flare Kit w/ Hardw., 76-83 CJ5, 76-86 CJ7, 81-86 CJ8*	11633.10

Rugged Ridge 7" 1987-95 (YJ) Wrangler Fender Flares use a 1997-06 Wrangler Style Rear Flare enabling it to cover a larger wheel space (as may be required by law). This feature also makes it necessary to cut the wheel housings to accept a larger size tire. Cutting & Drilling Required.

2 STAINLESS STEEL FASTENER KITS

These body hardware kits from Totally Stainless include stainless steel bolts, screws, washers, and nuts for your specific vehicle. Each grouping of fasteners is individually bagged and labeled.

DESCRIPTION	PART No.
1987-95 WRANGLER WITH HARDTOP, 754 PIECES	12215.11
1987-95 WRANGLER WITH SOFT TOP, 703 PIECES	12215.12
1987-95 WRANGLER 2" BODY MOUNTING WASHER KIT (8 pieces)	12217.03

3 BUMPERS

DESCRIPTION	PART No.
1987-95 WRANGLER, FRONT BUMPER (OE style)	12031.03
1987-95 WRANGLER, FRONT BUMPER ENDS	12031.04
1987-95 WRANGLER, BUMPERETTES (pair) LEFT & RIGHT PAIR, OE STYLE	11215.01
1997-06 WRANGLER, FRONT BUMPER (without hardware) BLACK	12033.02
1997-06 WRANGLER, FRONT BUMPER (without hardware) STAINLESS	11107.05
1997-06 WRANGLER, REAR BUMPER (without hardware) STAINLESS	11107.06
1997-06 WRANGLER, REAR BUMPER (without hardware) BLACK	12033.03
2007-10 WRANGLER WITH FOG LIGHTS AND TOW HOOKS, FRONT BUMPER COVER (NEW)	12040.05

4 BUMPER EXTENSIONS

DESCRIPTION	PART No.
1997-06 WRANGLER, FRONT LH BUMPER PLASTIC EXTENSION	12031.07
1997-06 WRANGLER, FRONT RH BUMPER PLASTIC EXTENSION	12031.08
1997-06 WRANGLER, REAR LH BUMPER PLASTIC EXTENSION	12031.09
1997-06 WRANGLER, REAR RH BUMPER PLASTIC EXTENSION	12031.10
SCREW (each), TJ WRANGLER BUMPER CORNER TO BUMPER BOTH FRONT AND REAR	12032.01

5 DOOR INSERTS

DESCRIPTION	PART No.
1987-06 WRANGLER, DOOR INSERTS (grommets) BLACK	11818.01
1987-06 WRANGLER, DOOR INSERTS (grommets) GRAY	11818.09
1987-06 WRANGLER, DOOR INSERTS (grommets) SPICE	11818.37

6 HOOD CATCH KITS

DESCRIPTION	PART No.
1997-06 WRANGLER, HOOD CATCH BRACKET BLACK (OE style) LH = RH	11210.06
1997-06 WRANGLER, HOOD CATCH BLACK (OE style) LH = RH	11210.07
1997-06 WRANGLER, HOOD CATCH KIT BLACK (OE style) LH = RH, EACH	11210.08
1997-06 WRANGLER, HOOD CATCH KIT (pair) BLACK (OE style) LH = RH	11210.09

7 WEATHER SEALS & MISCELLANEOUS PARTS

DESCRIPTION	PART No.
1987-95 COWL RUBBER SEAL	12302.04
1987-95 GLASS SEAL	12301.05
1987-95 WINDSHIELD GLASS LOCK SEAL (only)	12301.06
1987-95 WINDSHIELD GLASS SEAL CLIP	12301.07
1987-95 DOOR WEATHER SEAL PASSENGER SIDE	12303.02
1987-95 DOOR WEATHER SEAL DRIVER SIDE	12303.03
1997-06 W/ FULL DOOR, RH, WEATHERSTRIP OUTER DOOR	12303.12
1997-06 W/ FULL DOOR, LH, WEATHERSTRIP OUTER DOOR	12303.13
1997-06 RH, HALF DOOR, OUTER SEAL	12303.14
1997-06 LH, HALF DOOR, OUTER SEAL	12303.15
1987-95 TAILGATE SEAL	12305.02
1987-95 FLOOR PLUG (each)	12031.05
1987-95 LIFT GATE SUPPORT	12012.01
1997-05 WITH HARDTOP: LIFT GATE SUPPORT	12012.02
2006-10 WITH HARDTOP: LIFT GATE SUPPORT	12012.17
1987-95 TAILGATE'S UPPER WEATHERSTRIP (between liftgate & tailgate)	12304.09

Body kits, body tubs and body parts are sold "As Is". See Limited Warranty Information inside back cover. Drilling, cutting and other modifications may be required for proper installation. Claims for freight damage must be placed with freight carriers.



12035.03



11236.05



12035.12



11605.01



12035.04



12035.25



12035.16



12035.22

1 HOODS

DESCRIPTION	PART No.
1984-86	12035.01
1987-96	12035.02
1997-01	12035.03

2 TOW HOOK KIT

DESCRIPTION	PART No.
1984-01 HEAVY DUTY, FRONT (pair)	11236.05

3 FRONT FENDERS

DESCRIPTION	PART No.
1984-96 PASSENGER SIDE	12035.04
1984-96 DRIVER SIDE	12035.05
1997-01 PASSENGER SIDE	12035.06
1997-01 DRIVER SIDE	12035.07

4 FLARES (1984-96)

DESCRIPTION	PART No.
4 PIECE KIT	11605.01
FRONT PASSENGER SIDE	11605.02
FRONT DRIVER SIDE	11605.03
REAR PASSENGER SIDE	11605.04
REAR DRIVER SIDE	11605.05

5 1984-96 SIDE MIRRORS

DESCRIPTION	PART No.
PASSENGER SIDE, BLACK	12035.08
DRIVER SIDE, BLACK	12035.09
PASSENGER SIDE, BLACK, REMOTE	12035.10
DRIVER SIDE, BLACK, REMOTE	12035.11
PASSENGER SIDE, BLACK, REMOTE, POWER	12035.12
DRIVER SIDE, BLACK, REMOTE, POWER	12035.13
PASSENGER SIDE, CHROME, REMOTE	12035.14
DRIVER SIDE, CHROME, REMOTE	12035.15

6 1997-01 SIDE MIRRORS

DESCRIPTION	PART No.
PASSENGER SIDE, BLACK, REMOTE	12035.16
DRIVER SIDE, BLACK, REMOTE	12035.17
PASSENGER SIDE, BLACK, REMOTE, POWER	12035.18
DRIVER SIDE, BLACK, REMOTE, POWER	12035.19
PASSENGER SIDE, BLACK, REMOTE, POWER, HEATED	12035.20
DRIVER SIDE, BLACK, REMOTE, POWER, HEATED	12035.21

7 GRILLE INSERTS

DESCRIPTION	PART No.
1984-87 CHEROKEE, BLACK/GRAY	12035.25
1984-90 CHEROKEE, BLACK/CHROME	12035.26
1987-90 CHEROKEE, BLACK/BLACK	12035.27
1991-92 CHEROKEE, BLACK	12035.28
1993-96 CHEROKEE, BLACK	12035.29
1991-96 CHEROKEE, BLACK/CHROME	12035.30
1997-01 CHEROKEE, BLACK (Country models)	12035.31
1997-01 CHEROKEE, BLACK (SE & Sport models)	12035.32

8 FRONT GRILLE SUPPORT

DESCRIPTION	PART No.
1984-90 CHEROKEE	12035.22
1991-96 CHEROKEE	12035.23
1997-01 CHEROKEE	12035.24

See our Surplus Section for a wide selection brand new, original Jeep® parts.

Body kits, body tubs and body parts are sold "As Is". See Limited Warranty Information inside back cover. Drilling, cutting and other modifications may be required for proper installation. Claims for freight damage must be placed with freight carriers.



1 BUMPERS

DESCRIPTION	PART No.
1984-96 FRONT BUMPER, BLACK	12035.40
1984-96 REAR BUMPER, BLACK	12035.41
1984-96 FRONT BUMPER, CHROME	12035.42
1984-96 REAR BUMPER, CHROME	12035.43
1997-01 FRONT BUMPER, BLACK	12035.44
1997-01 REAR BUMPER, BLACK	12035.45
1984-96 REAR BUMPER BRACKET ASSEMBLY (NEW)	12035.55
1997-01 FRONT BUMPER, CHROME (NEW)	12035.61
1997-01 REAR BUMPER, CHROME (NEW)	12035.62

2 BUMPER GUARDS

DESCRIPTION	PART No.
1984-96 FRONT, PASSENGER SIDE	12035.34
1984-96 FRONT, DRIVER SIDE	12035.35
1984-96 REAR, PASSENGER SIDE	12035.36
1984-96 REAR, DRIVER SIDE	12035.37

3 BUMPER END CAPS

DESCRIPTION	PART No.
1984-96 FRONT, PASSENGER SIDE	12035.46
1984-96 FRONT, DRIVER SIDE	12035.47
1984-96 REAR, PASSENGER SIDE	12035.48
1984-96 REAR, DRIVER SIDE	12035.49

4 DOOR CYLINDERS & LOCKS

DESCRIPTION	PART No.
1991-94 CHEROKEE	11813.03
1995-96 CHEROKEE	11813.04
1997-01 CHEROKEE	11813.05

5 OUTER DOOR HANDLES

DESCRIPTION	PART No.
1984-96 FRONT OR REAR DOOR, RH	12035.38
1984-96 FRONT OR REAR DOOR, LH	12035.39

6 LIFTGATE SUPPORTS

DESCRIPTION	PART No.
1984-94 CHEROKEE	12012.03
1995-96 CHEROKEE	12012.04
1997-01 CHEROKEE	12012.05

7 WEATHERSTRIPPING

DESCRIPTION	PART No.
1984-96 LH=RH, REAR DOOR GLASS FRONT BELT SEAL	12303.61
1984-96 RH, REAR DOOR GLASS RUN SEAL	12303.62
1984-96 LH, REAR DOOR GLASS RUN SEAL	12303.63
1984-95 LH=RH, REAR DOOR GLASS OUTER BELT REAR SEAL	12303.64
1984-96 RH FRONT DOOR INNER GLASS SEAL	12303.66
1984-96 LH FRONT DOOR INNER GLASS SEAL	12303.67
1984-01 LIFT-GATE WEATHERSTRIP	12303.68
1989-96 OUTER DOOR SEAL	12303.69
FRONT=REAR, LH=RH	12303.70
1984-96 REAR DOOR GLASS INNER BELT SEAL RH	12303.71
1984-96 REAR DOOR GLASS INNER BELT SEAL LH	12303.70
1984-96 FRONT DOOR GLASS OUTER SEAL RH	12303.72
1984-96 FRONT DOOR GLASS OUTER SEAL LH	12303.73
1984-96 FRONT DOOR GLASS RUN RH	12303.74
1984-96 FRONT DOOR GLASS RUN LH	12303.75

8 HEAVY DUTY STEERING GEAR BOX BRACE

DESCRIPTION	PART No.
1984-01 CHEROKEE	18021.05

9 HEAVY DUTY TRANSFER CASE CROSSMEMBER

DESCRIPTION	PART No.
1984-01 CHEROKEE	12035.60

1993-09 GRAND CHEROKEE BODY PARTS

Body kits, body tubs and body parts are sold "As Is". See Limited Warranty Information inside back cover. Drilling, cutting and other modifications may be required for proper installation. Claims for freight damage must be placed with freight carriers.



1 TOW HOOK

DESCRIPTION	PART No.
1993-98 HEAVY DUTY (pair)	11236.06

2 HOODS

DESCRIPTION	PART No.
1993-98	12037.01
1999-04	12039.01
2005-06	12041.01

3 HOOD SUPPORT STRUTS

DESCRIPTION	PART No.
1999-03 FITS EITHER SIDE	12012.11
2004 FITS EITHER SIDE	12012.12
2005-07 FITS EITHER SIDE	12012.14

4 DOOR CYLINDERS & LOCKS

DESCRIPTION	PART No.
1991-94	11813.03
1995	11813.04
1996-98	11813.05
1999-04	11813.06

5 FENDERS

DESCRIPTION	PART No.
1993-98 PASSENGER SIDE	12037.02
1993-98 DRIVER SIDE	12037.03
1999-04 PASSENGER SIDE	12039.02
1999-04 DRIVER SIDE	12039.03
2005-06 DRIVER SIDE	12041.03
2005-06 PASSENGER SIDE	12041.02

6 HEADER PANEL (grille support)

DESCRIPTION	PART No.
1993-95	12037.04
1996-98	12037.05
1999-03	12039.04

7 GRILLES

DESCRIPTION	PART No.
1993-95 CHROME-SILVER-GRAY	12037.12
1993-95 PAINTED BLACK	12037.13
1996-98 CHROME DARK, ARGENT	12037.14
1996-98 DARK, ARGENT	12037.15
1999-04 INNER GRILLE SUPPORT	12039.05

8 CROSSMEMBERS

DESCRIPTION	PART No.
1993-98 FRONT	12037.08
1993-98 LOWER RADIATOR	12037.09

Body kits, body tubs and body parts are sold "As Is". See Limited Warranty Information inside back cover. Drilling, cutting and other modifications may be required for proper installation. Claims for freight damage must be placed with freight carriers.



1 REAR BUMPERS

DESCRIPTION	PART No.
1993-98 REAR, BLACK	12037.10
1993-98 REAR, GRAY	12037.11

2 FRONT BUMPER COVERS

DESCRIPTION	PART No.
1996-98 LAREDO WITH FOG LIGHTS	12037.29
1996-98 LAREDO WITHOUT FOG LIGHTS	12037.28
1999 LAREDO WITH FOG LIGHTS	12039.21
1999 LAREDO WITHOUT FOG LIGHTS	12039.20
1999-00 LIMITED	12039.23
1999-02 LAREDO / SPORT WITH FOG LIGHTS	12039.22
2001-03 LIMITED (NEW)	12039.24
2005-06 WITH CHROME INSERT	12041.06
2005-06 WITHOUT CHROME EXCEPT SRT-8	12041.05

3 MIRRORS

DESCRIPTION	PART No.
1993-96 POWER WITHOUT HEATER, RH	12037.16
1993-96 POWER WITHOUT HEATER, LH	12037.17
1993-95 POWER WITH HEATER, RH	12037.18
1993-95 POWER WITH HEATER, LH	12037.19
1996-98 POWER WITH HEATER, RH	12037.20
1996-98 POWER WITH HEATER, LH	12037.21
1999-04 POWER WITHOUT HEATER, RH	12039.06
1999-04 POWER WITHOUT HEATER, LH	12039.07
1999-02 POWER WITH HEATER, RH	12039.08
1999-02 POWER WITH HEATER, LH	12039.09

4 EXTERIOR DOOR HANDLES

DESCRIPTION	PART No.
1993-98 PASSENGER SIDE RH, FRONT	12037.22
1993-98 DRIVER SIDE LH, FRONT	12037.23
1993-98 PASSENGER SIDE RH, REAR	12037.24
1993-98 DRIVER SIDE LH, REAR	12037.25

5 LIFTGATE DOOR SUPPORT STRUTS

DESCRIPTION	PART No.
1993-98 PASSENGER SIDE	12012.06
1993-98 DRIVER SIDE	12012.07
1999-04 FITS EITHER SIDE	12012.08
2005-07 FITS EITHER SIDE (NEW)	12012.18

6 LIFTGATE GLASS SUPPORT STRUTS

DESCRIPTION	PART No.
1996-98 FITS EITHER SIDE	12012.09
1999-04 FITS EITHER SIDE	12012.10
2005-07 FITS EITHER SIDE	12012.16
2008-09 SUPPORT LIFTGATE (NEW)	12012.18



2004-07 LIBERTY BODY PARTS

Body kits, body tubs and body parts are sold "As Is". See Limited Warranty Information inside back cover. Drilling, cutting and other modifications may be required for proper installation. Claims for freight damage must be placed with freight carriers.



1 HOOD

DESCRIPTION	PART No.
2002-04 LIBERTY	12042.01

2 HOOD SUPPORT STRUTS

DESCRIPTION	PART No.
2002-06 LIBERTY, FITS EITHER SIDE	12012.13

3 HEADER PANEL (grille support)

DESCRIPTION	PART No.
2002-04 LIBERTY	12042.04

4 FRONT BUMPER COVERS

DESCRIPTION	PART No.
2002-04 LIBERTY	12042.05
2002-04 LIBERTY RENEGADE	12042.07
2002-04 LIBERTY SPORT TEXTURED	12042.06

5 FENDERS

DESCRIPTION	PART No.
2002-04 LIBERTY, LEFT SIDE	12042.03
2002-04 LIBERTY, RIGHT SIDE	12042.02

6 MIRRORS

DESCRIPTION	PART No.
2002-06 Liberty, Fold Away Without Power, LEFT	12042.11
2002-06 Liberty, Fold Away Without Power, RIGHT	12042.10
2002-06 Liberty, Heated with Power, LEFT SIDE	12042.15
2002-06 Liberty, Heated with Power, RIGHT SIDE	12042.14
2002-06 Liberty, Power, LEFT SIDE	12042.13
2002-06 Liberty, Power, RIGHT SIDE	12042.12

7 LIFTGATE DOOR SUPPORT STRUTS

DESCRIPTION	PART No.
2002-06 LIBERTY, FITS EITHER SIDE	12012.15

8 OUTER DOOR HANDLES

DESCRIPTION	PART No.
2002-05 LIBERTY, LEFT FRONT	12042.31
2002-05 LIBERTY WITH LOCK, RIGHT FRONT	12042.32
2002-07 LIBERTY, LEFT REAR	12042.35
2002-07 LIBERTY, RIGHT REAR	12042.36
2004-07 LIBERTY, RIGHT FRONT WITHOUT LOCK	12042.34

9 DOOR CYLINDER & LOCK

DESCRIPTION	PART No.
2004 LIBERTY	11813.06



FRONT DANA MODEL 25 & 27

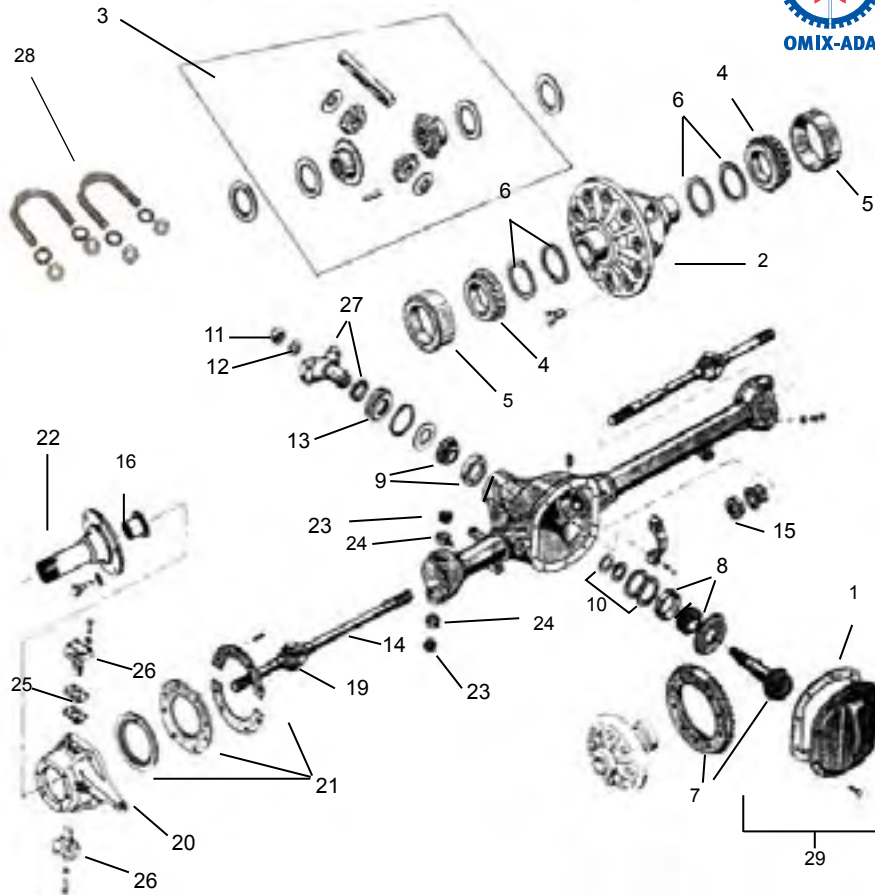

1946-71 CJ FRONT DANA MODEL 25 & 27

DESCRIPTION	PART #	DESCRIPTION	PART #
1 GASKET, FRONT AXLE COVER	16502.01	14 FRONT AXLE SHAFT ASSEMBLY INNER & OUTER WITH U-JOINT: PASSENGER SIDE (short)	16523.02
2 CASE, STANDARD DIFFERENTIAL: DANA-27 3.31 TO 3.73 RATIO	16503.02	DRIVER SIDE (long)	16523.01
3 SPIDER GEAR KIT STD. DIFFERENTIAL	16507.01	15 OIL SEAL, INNER AXLE	16526.01
4 BEARING, DIFFERENTIAL SIDE, DANA -25 (2 needed)	16509.01	16 BUSHING, SPINDLE	16529.02
DANA-27 (2 needed)	16706.02	17 GASKET, AXLE SHAFT FLANGE DRIVE (not shown)	16727.02
5 CUP, DIFFERENTIAL SIDE, DANA-25 (2 needed)	16509.03	18 FLANGE, AXLE SHAFT DRIVE, LEFT OR RIGHT (not shown)	16750.08
DANA-27 (2 needed)	16509.04	19 U-JOINT, FRONT AXLE, GREASABLE, LEFT OR RIGHT	16525.01
6 SHIM KIT DIFFERENTIAL SIDE BEARINGS	16511.01	U-JOINT, FRONT AXLE, GREASABLE, LEFT OR RIGHT, SPICER	16525.02
7 RING & PINION: DANA-25 4.88 RATIO, 39X8 TEETH (ltd. qty.)	16513.02	U-JOINT, FRONT AXLE, NON-GREASABLE, LEFT OR RIGHT, SPICER	16525.03
8 INNER PINION BEARING & CUP KIT: DANA-25	16515.01	20 KNUCKLE (late CJ2A,3A,3B,CJ5,CJ6) LEFT	18026.01
DANA-27	16515.02	RIGHT	18026.02
9 OUTER PINION BEARING & CUP KIT DANA-25 & DANA-27	16517.01	21 STEERING KNUCKLE SEAL KIT (each side)	18026.03
10 SHIM KIT PINION BEARING	16519.01	22 SPINDLE	16529.01
11 PINION NUT	16584.01	23 BEARING, KING PIN (each)	18026.05
12 PINION WASHER	16584.02	24 CUP, KING PIN (each)	18026.06
13 PINION OIL SEAL	16521.01	25 SHIM SET, KING PIN BEARING (each)	18026.07
PINION OIL SEAL, NATIONAL BRAND	16521.02	26 CAP, KING PIN	18026.04
		27 YOKE: DANA-25 (10 spline)	16580.04
		DANA-27 (10 spline)	16580.01
		28 U-BOLT PAIR KIT FOR U-BOLT STYLE YOKE	16582.01
		U-BOLT PAIR KIT FOR U-BOLT STYLE YOKE-SPICER	16582.02
		29 DIFFERENTIAL COVER KIT STAINLESS STEEL, INC. GASKET & HARDWARE	11118.02

2003-10 WRANGLER FRONT DANA 44

DESCRIPTION	PART #
PINION OIL SEAL, INNER, 2003-06 WRANGLER	16521.15
PINION NUT, 2003-06 WRANGLER (NEW)	16584.04
OUTER PINION OIL SLINGER, 2007-10 (NEW)	16512.61
PINION SHIM KIT, 2007-10 WRANGLER, 0.050-0.054"	16519.05
PINION SHIM KIT, 2007-10 WRANGLER, 0.035-0.039" (NEW)	16519.02
PINION SHIM KIT, 2007-10 WRANGLER, 0.040-0.044" (NEW)	16519.03
PINION SHIM KIT, 2007-10 WRANGLER, 0.045-0.049" (NEW)	16519.04
PINION CRUSH SLEEVE, 2007-10 WRANGLER (NEW)	16512.65
RING & PINION GEAR, 4.10:1 2003-06 WRANGLER	16514.43
DIFFERENTIAL CASE ASSEMBLY KIT, 2003-06 WRANGLER RUBICON TRULOK 4.10, 4.56	16505.26
DIFFERENTIAL BEARING CAP BOLT, 2003-06 WRANGLER	16584.11
DIFFERENTIAL COVER GASKET, 2003-06 WRANGLER	16502.05
AXLE SHAFT, LH 2003-06 WRANGLER RUBICON	16523.41
AXLE SHAFT, RH 2003-06 WRANGLER RUBICON (NEW)	16523.46



FRONT DANA MODEL 30

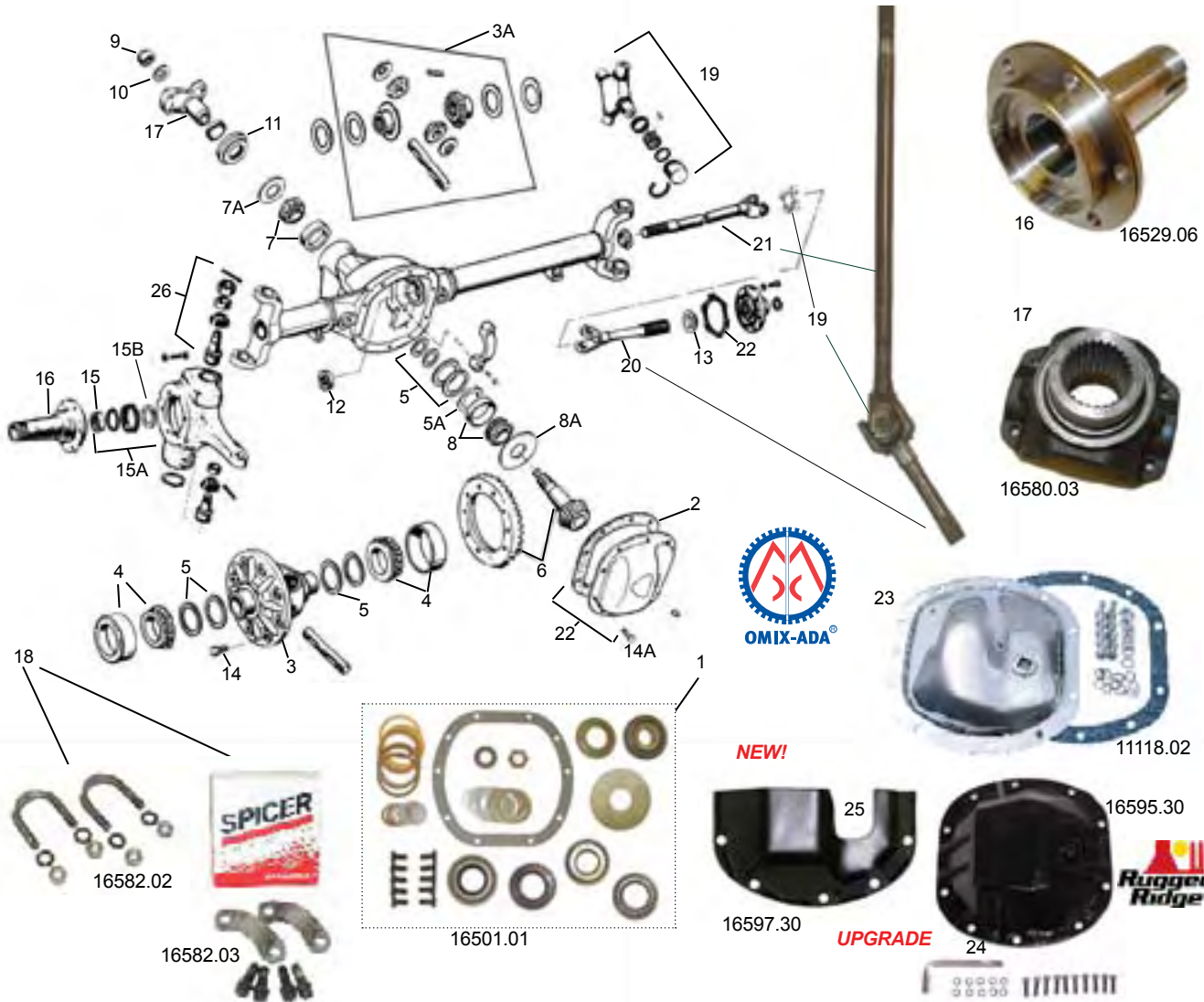

1972-86 CJ FRONT DANA MODEL 30

DESCRIPTION	PART #	DESCRIPTION	PART #
1 MASTER REBUILD KIT, (bearings, seal, shim set & hardware)	16501.01	15 SPINDLE BEARING (bearing alone without hardware)	16529.03
2 GASKET, FRONT AXLE COVER	16502.01	15A SPINDLE BEARING, SEAL, WASHER KIT, LEFT OR RIGHT, 1977-86 CJ	16529.04
3 DIFFERENTIAL CASE, STANDARD (with gasket, shims & ring bolts)	16503.04	15B SPINDLE THRUST WASHER 1972-77 CJ WITH FRONT DRUM BRAKE	16529.05
WITH 2.72 TO 3.54 RATIO	16503.49	16 SPINDLE 1972-77 CJ WITH DRUM BRAKE	16529.06
1976-80 4.09 & 4.10 CJ, 1981 3.73 CJ - DIFFERENTIAL CASE ASSEMBLY	16503.05	17 SPINDLE 1977-86 CJ WITH DISC BRAKE	16529.07
FRONT DANA-30 WITH 3.73 TO 5.38 RATIO	16507.02	17 YOKE, 1972-86 CJ (U-bolt style)	16580.02
3A SPIDER GEAR KIT STANDARD DIFFERENTIAL (with gasket & bolts)	16509.05	YOKE, 1981-86 CJ (strap & bolt style)	16580.03
4 BEARING KIT, DIFFERENTIAL SIDE (2 bearings & 2 cups)	16512.01	YOKE KIT DANA 30, JEEP CJ 72-86, WRANGLER (YJ) 87-95, (TJ) 97-06, CHEROKEE (XJ) 84-01 (NEW)	16580.27
5 SHIM SET KIT, FOR SIDE BEARINGS & PINION BEARINGS & HARDWARE	16512.01	18 U-BOLT PAIR KIT FOR 16580.02 YOKE	16582.01
5A INNER PINION BEARING BAFFLE	16512.53	U-BOLT PAIR KIT FOR 16580.02 YOKE, SPICER	16582.02
6 RING & PINION KIT (w/ pinion bearings & cups, pinion nut & washer, oil seal & slinger, ring bolts, shim kit)	16513.11	STRAP & BOLT KIT FOR 16580.03 YOKE	16582.03
3.54 RATIO (46x13 teeth)	16513.12	19 U-JOINT KIT FOR AXLE, LEFT OR RIGHT	16525.01
3.73 RATIO (41x11 teeth)	16513.13	GREASABLE	16525.02
4.10 RATIO (41x10 teeth)	16513.14	GREASABLE, SPICER	16525.02
4.27 RATIO (47x11 teeth)	16513.15	NON-GREASABLE, SPICER	16525.03
4.56 RATIO (41x9 teeth)	16517.01	20	
7 OUTER PINION BEARING KIT (1 bearing & 1 cup)	16517.01	21 FRONT AXLE SHAFT ASSEMBLY	16523.05
7A OUTER PINION OIL SLINGER	16512.52	1977-82 DISC BRAKE, DRIVER SIDE	16523.04
8 INNER PINION BEARING KIT (1 bearing & 1 cup)	16515.02	1977-82 DISC BRAKE, PASSENGER SIDE	16523.07
8A INNER PINION OIL SLINGER	16512.51	1982-86 CJ7, CJ8, DRIVER SIDE	16523.06
9 NUT, PINION	16584.01	1982-86 CJ7, CJ8, PASSENGER SIDE	16727.02
10 WASHER, PINION	16584.02	22 GASKET, DRIVE FLANGE	
11 OIL SEAL, PINION	16521.01	23 DIFFERENTIAL COVER KIT, STAINLESS STEEL, W/ GASKET & HARDWARE	11118.02
OIL SEAL, PINION, NATIONAL BRAND	16521.02	24 HEAVY DUTY DIFFERENTIAL COVER, 3/8" THICK CAST STEEL, WITH HARDWARE (UPGRADE)	16595.30
12 OIL SEAL, INNER SIDE OF THE AXLE	16526.02	25 HEAVY DUTY DIFFERENTIAL SKID PLATE, 3/8" THICK CAST STEEL, WITH HARDWARE (UPGRADE)	16597.30
13 DUST SHIELD, INNER AXLE, LEFT OR RIGHT	16527.04	AXLE BREATHER	16561.01
14 BOLT FOR RING GEAR (each, 10 needed)	16522.01	26 BALL JOINT KIT (upper & lower w/ hardware)	18036.01
14A DIFF. COVER BOLT, DANA-30, 35, 44, AMC-20	16522.02		

SPINDLE NUT SOCKET:

DESCRIPTION	PART #	PRICE
1945-86 CJ SPINDLE NUT SOCKET	16711.01	16711.01



Axle & Differential

FRONT DANA-30 WITH DISCONNECT

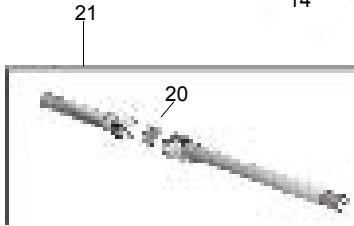

UPGRADE

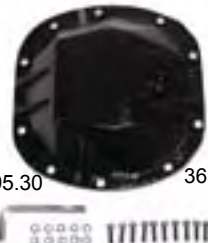

NEW!



1987-95 WRANGLER & 1984-91 CHEROKEE FRONT DANA-30 WITH DISCONNECT

DESCRIPTION	PART #	DESCRIPTION	PART #
1 REBUILD KIT (bearings, seal, shims & hardware)	16501.02	19 STRAP & BOLT KIT FOR STRAP & BOLT STYLE YOKE	16582.03
2 GASKET, FRONT AXLE COVER	16502.01	20 U-JOINT KIT, LEFT OR RIGHT	
3 STANDARD DIFFERENTIAL CASE (with gasket, shims & ring bolts)		1987-94, GREASABLE,	16525.01
WITH 2.73 TO 3.55 RATIO	16503.04	1987-94, GREASABLE, SPICER BRAND	16525.02
WITH 3.73 TO 4.56 RATIO	16503.05	1987-94, NON-GREASABLE, SPICER BRAND	16525.03
3A SPIDER GEAR KIT STANDARD DIFFERENTIAL		1995, GREASABLE,	16525.04
(with seal & bolts)	16507.03	1995, NON-GREASABLE, SPICER BRAND	16525.05
3B CASE ASSEMBLY KIT STANDARD DIFFERENTIAL:		1995-UP, GREASABLE, SPICER BRAND	16525.06
1990-96, 3.07-3.55 RATIO, SPICER (item #3&3A)	16505.01	21 AXLE SHAFT ASSEMBLY,	
1990-96, 3.73-4.10 RATIO, SPICER (item #3&3A)	16505.02	OUTER PASSENGER SIDE 1987-95 W/O ABS	16523.08
1987-89, 3.07-3.55 RATIO, SPICER (item #3&3A)	16505.03	OUTER PASSENGER SIDE 1990-95 WITH ABS	16523.10
1987-89, 3.73-4.10 RATIO, SPICER (item #3&3A)	16505.04	DRIVER SIDE, 1987-95 WITHOUT ABS	16523.09
4 BEARING KIT DIFFERENTIAL SIDE		DRIVER SIDE, 1990-95 WITH ABS	16523.11
(2 bearings & 2 cups)	16509.05	22 OUTER AXLE SHAFT, 1987-94 (without ABS),	
5 SHIM SET KIT, FOR SIDE BEARINGS		FITS LEFT OR RIGHT	16523.13
& PINION BEARINGS & HARDWARE	16512.02	23 1987-89 INNER BUSHING BEARING (NEW)	16527.20
6 RING & PINION KIT (with pinion bearings & cups, pinion nut & washer,		1990-95 INNER BUSHING BEARING (without ABS)	16527.06
oil seal & slinger, ring bolts, shim kit) (all ring & pinions are reverse rotation)		24 1987-89 OUTER BEARING	16527.07
3.07 RATIO (43X14 TEETH)	16513.20	1990-95 OUTER BEARING	16527.08
3.54 RATIO (39X11 TEETH)	16513.21	25 1991-95 AXLE DISCONNECT MOTOR ASSEMBLY	16527.10
3.73 RATIO (41X11 TEETH)	16513.22	27 1987-95 AXLE DISCONNECT SHIFT FORK	16527.12
4.10 RATIO (41X10 TEETH)	16513.23	28 1987-95 AXLE DISCONNECT MOTOR	
4.56 RATIO (41X9 TEETH)	16513.24	RETAINING CLIP	16527.13
4.88 RATIO (ring & pinion only, need separate rebuild kit)	16513.25	29 1987-95 AXLE DISCONNECT SHIFT FORK INSERT	16527.14
7 OUTER PINION BEARING KIT (1 bearing & 1 cup)	16517.01	33 1987-95 AXLE DISCONNECT SHIFT FORK	
8 OUTER PINION BEARING OIL SLINGER	16512.52	SNAP RING	16527.18
9 INNER PINION BEARING KIT (1 bearing & 1 cup)	16515.02	34 1987-95 AXLE DISCONNECT HOUSING	
9A INNER PINION OIL SLINGER	16512.51	COVER GASKET	16527.19
10 INNER PINION BEARING STIFFE	16512.53	35 DIFFERENTIAL COVER KIT STAINLESS STEEL	
11 NUT, PINION	16584.01	INCLUDES GASKET & BOLTS	11118.01
12 WASHER, PINION	16584.02	36 HEAVY DUTY DIFFERENTIAL COVER, 3/8" THICK	
13 OIL SEAL, PINION	16521.01	CAST STEEL, WITH HARDWARE (UPGRADE)	16595.30
OIL SEAL, PINION-NATIONAL BRAND	16521.02	37 HEAVY DUTY DIFFERENTIAL SKID PLATE, 3/8"	
14 OIL SEAL, INNER SIDE OF THE AXLE, RH		THICK CAST STEEL, W/ HARDWARE (UPGRADE)	16597.30
2.12" O.D.	16526.03	38 BALL JOINT KIT (upper & lower with hardware)	18036.02
2.29" O.D. (NEW)	16526.06		
15 OIL SEAL, INNER SIDE OF THE AXLE, LH	16526.02		
16 BOLT FOR RING GEAR (each, 10 needed)	16522.01		
16A DIFF COVER BOLT, DANA-30, 35, 44, & AMC-20	16522.02		
17 YOKE, U-BOLT STYLE	16580.02		
18 YOKE, STRAP & BOLT STYLE	16580.07		
U-BOLT PAIR KIT FOR U-BOLT STYLE YOKE	16582.01		
SPICER BRAND	16582.02		

FRONT DANA-30 WITHOUT DISCONNECT

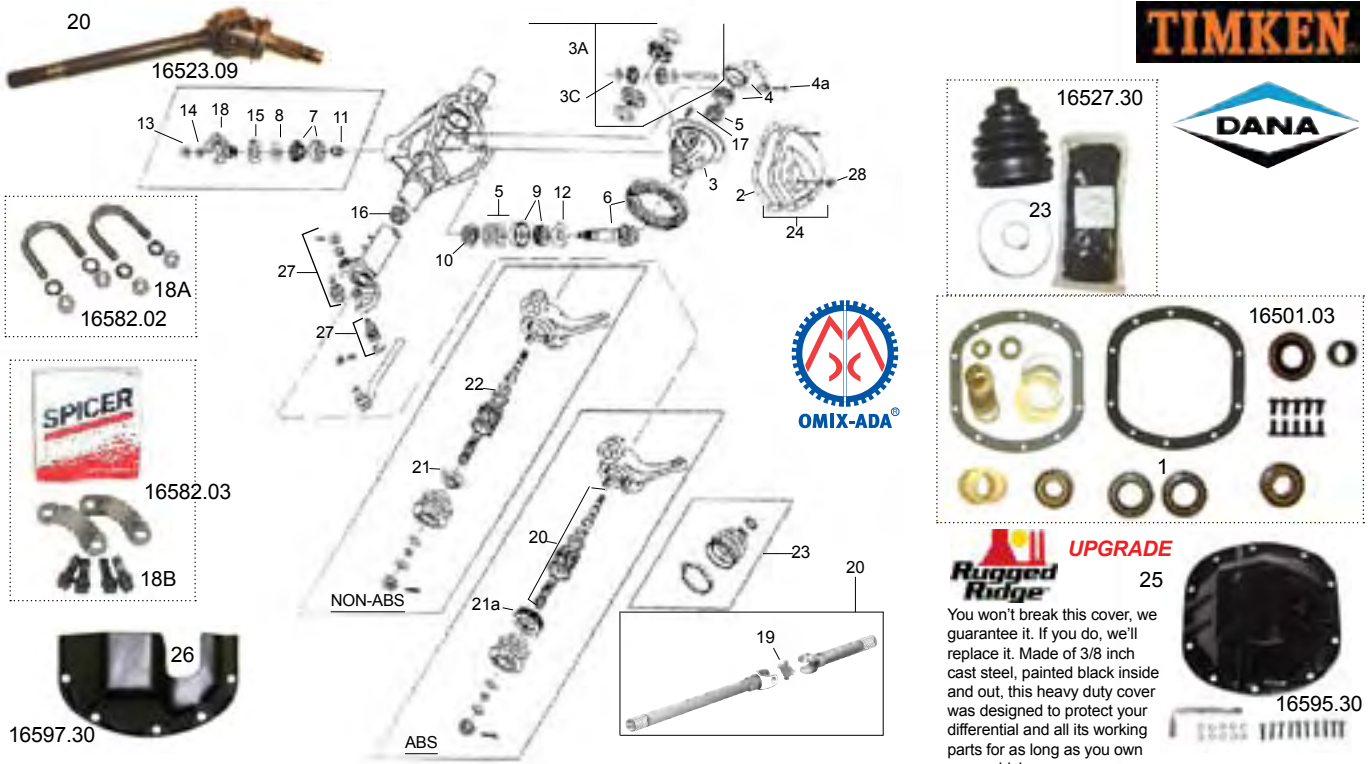

1997-10 WRANGLER, 1992-01 CHEROKEE, 1993-98 GRAND CHEROKEE & 2002-07 LIBERTY FRONT DANA-30 WITHOUT DISCONNECT

DESCRIPTION	PART #	DESCRIPTION	PART #
1 REBUILD KIT (bearings, seal, shims & hardware)	16501.03	9 INNER PINION BEARING KIT (1 bearing & 1 cup)	16515.02
2 GASKET, FRONT AXLE COVER	16502.01	10 INNER PINION BEARING BAFFLE	16512.53
3 DIFFERENTIAL CASE, STANDARD (with gasket, shims & ring bolts)		11 COLLAPSIBLE PINION SPACER	16512.54
WITH 2.73 TO 3.55 RATIO	16503.04	COLLAPSIBLE PINION SPACER 97-04 TJ (NEW)	16512.63
WITH 3.73 TO 4.56 RATIO	16503.05	COLLAPSIBLE PINION SPACER 02-06 KJ (NEW)	16512.65
3A SPIDER GEAR KIT STD. DIFF. (with seal & bolts) (ALL)	16507.04	COLLAPSIBLE PINION SPACER 07-10 JK (NEW)	16512.65
3A CROSS SHAFT (NEW)	16507.61	12 INNER PINION OIL SLINGER, 92-98	16512.51
3B DIFFERENTIAL CASE ASSEMBLY KITS		INNER PINION OIL SLINGER 07-10 JK (NEW)	16512.61
1999 CHEROKEE 3.07, 3.55	16505.18	INNER PINION OIL SLINGER 02-06 KJ (NEW)	16512.66
1999-06 WRANGLER 3.07, 3.55	16505.18	INNER PINION OIL SLINGER, 99-06 TJ (NEW)	16512.58
2002-03 GRAND CHEROKEE 3.55:1 W/ HYDRALOK	16505.16	INNER PINION OIL SLINGER, 99-01 XJ (NEW)	16512.58
2002-07 LIBERTY 3:73, 4.10 (NEW)	16503.52	INNER PINION OIL SLINGER, 99 WJ (NEW)	16512.58
2005-06 LIBERTY 3:55	16505.15	13 PINION NUT, EXCEPT 1999-04 GRAND CHEROKEE	16584.01
3B DIFFERENTIAL CASE KIT		13 PINION NUT, 1999-04 GRAND CHEROKEE (NEW)	16584.04
1999 CHEROKEE 3.07, 3.55 (NEW)	16503.61	14 WASHER, PINION	16584.02
3C DIFF. PINION THRUST WASHER, 99-06 (NEW)	16584.06	15 OIL SEAL, PINION	16521.01
4 BEARING KIT DIFFERENTIAL SIDE		OIL SEAL, PINION-NATIONAL BRAND	16521.02
(2 bearings & 2 cups)	16509.05	OIL SEAL, PINION, FLANGED (NEW)	16521.12
4A DIFFERENTIAL BEARING CAP BOLT	16584.11	16 OIL SEAL, INNER SIDE OF THE AXLE, LH=RH	16526.02
5 DIFFERENTIAL BEARING SHIM SET, 99-01 XJ (NEW)	16512.05	17 BOLT FOR RING GEAR (each, 10 needed)	16522.01
5 DIFFERENTIAL BEARING SHIM SET, 99-06 TJ (NEW)	16512.06	18 YOKE, U-BOLT STYLE	16580.02
5 PINION BEARING SHIM SET		YOKE, STRAP & BOLT STYLE	16580.07
2007-10 WRANGLER, 0.035-0.039" (NEW)	16519.02	18A U-BOLT PAIR KIT FOR U-BOLT STYLE YOKE	16582.01
2007-10 WRANGLER, 0.040-0.044" (NEW)	16519.03	SPICER BRAND	16582.02
		18B STRAP & BOLT KIT FOR STRAP & BOLT STYLE YOKE	16582.03
2007-10 WRANGLER, 0.045-0.049" (NEW)	16519.04	19 U-JOINT KIT, LEFT OR RIGHT	
2007-10 WRANGLER, 0.050-0.054"	16519.05	GREASABLE	16525.04
5 SHIM SET KIT, FOR SIDE BEARINGS		NON-GREASABLE, SPICER BRAND	16525.05
& PINION BEARINGS + HARDWARE	16512.03	GREASABLE, SPICER BRAND	16525.06
6 RING & PINION KIT (with pinion bearings & cups, pinion nut & washer, oil seal & slinger, ring bolts, & shim kit)		20 AXLE SHAFT ASSEMBLY	
3.07 RATIO (43X14 TEETH)	16513.30	PASSENGER SIDE, WITHOUT ABS	16523.16
3.55 RATIO (39X11 TEETH)	16513.31	PASSENGER SIDE, WITH ABS	16523.18
3.73 RATIO (41X11 TEETH)	16513.32	DRIVER SIDE, WITHOUT ABS	16523.09
4.10 RATIO (41X10 TEETH)	16513.33	DRIVER SIDE, WITH ABS	16523.11
3.07 RATIO 2001-06 WRANGLER (NEW)	16514.36	FRONT, PASSENGER SIDE (inner & outer CV shaft)	16523.20
3.07 RATIO 2001 CHEROKEE (NEW)	16514.36	FRONT, DRIVER SIDE (inner & outer CV shaft)	16523.21
3.55 RATIO 1993-96 GRAND CHEROKEE	16513.38	1993-98 GRAND CHEROKEE FRONT AXLE CV	16523.22
3.73 RATIO 1993-96 GRAND CHEROKEE	16513.39	JOINT (outer shaft only) (boot & clamp & grease)	16523.46
6a RING & PINION GEARS ONLY		RH 03-06 TJ RUBICON FRONT DANA 44 (NEW)	16523.46
3.55 RATIO 1999-03 GRAND CHEROKEE W/ ABS	16514.38	21 OUTER AXLE DUST SHIELD	16527.21
3.55 RATIO 2000 CHEROKEE	16514.39	21a OUTER AXLE TONE RING, 99-06 TJ w/ ABS (NEW)	16527.42
3.55 RATIO 2001 CHEROKEE	16514.47	22 INNER AXLE DUST SHIELD	16527.22
3.55 RATIO 2002 WRANGLER	16514.47	23 OUTER AXLE OIL SLINGER, 93-98 ZJ (NEW)	16512.57
3.55 RATIO 2005-06 LIBERTY	16514.45	24 BOOT KIT, CHEROKEE CV STYLE AXLE	16527.30
3.73 RATIO 2001 WRANGLER DIESEL	16514.53	24 DIFFERENTIAL COVER KIT, 99-06 TJ (NEW)	16595.81
3.73 RATIO 2002-06 WRANGLER, 2005 LIBERTY (NEW)	16513.90	24 DIFFERENTIAL COVER KIT, 02-06 KJ (NEW)	16595.82
3.73 RATIO 2002-07 LIBERTY	16514.50	24 DIFFERENTIAL COVER KIT STAINLESS STEEL	
4.10 RATIO 2002-06 LIBERTY	16514.44	INCLUDES GASKET & BOLTS	11118.02
4:10 RATIO 2001-04 WRANGLER	16514.42	25 HEAVY DUTY DIFFERENTIAL COVER, 3/8" THICK	
4.56 RATIO (41X9 TEETH)	16513.34	CAST STEEL, WITH HARDWARE (UPGRADE)	16595.30
4.88 RATIO	16513.35	26 HEAVY DUTY DIFFERENTIAL SKID PLATE, 3/8"	
7 OUTER PINION BEARING KIT (1 bearing & 1 cup)	16517.02	THICK CAST STEEL, W/ HARDWARE (UPGRADE)	16597.30
8 OUTER PINION OIL SLINGER	16512.52	27 1987-06 BALL JOINT KIT (upper & lower w/ hardware)	18036.02
OUTER PINION OIL SLINGER 02-06 KJ (NEW)	16512.61	28 DIFFERENTIAL COVER PLUG	
OUTER PINION OIL SLINGER 07-10 JK (NEW)	16512.61	1999-06 WRANGLER (NEW)	16595.95
		1999-01 CHEROKEE (NEW)	16595.95
		1999-04 GRAND CHEROKEE (NEW)	16595.96

Axle & Differential

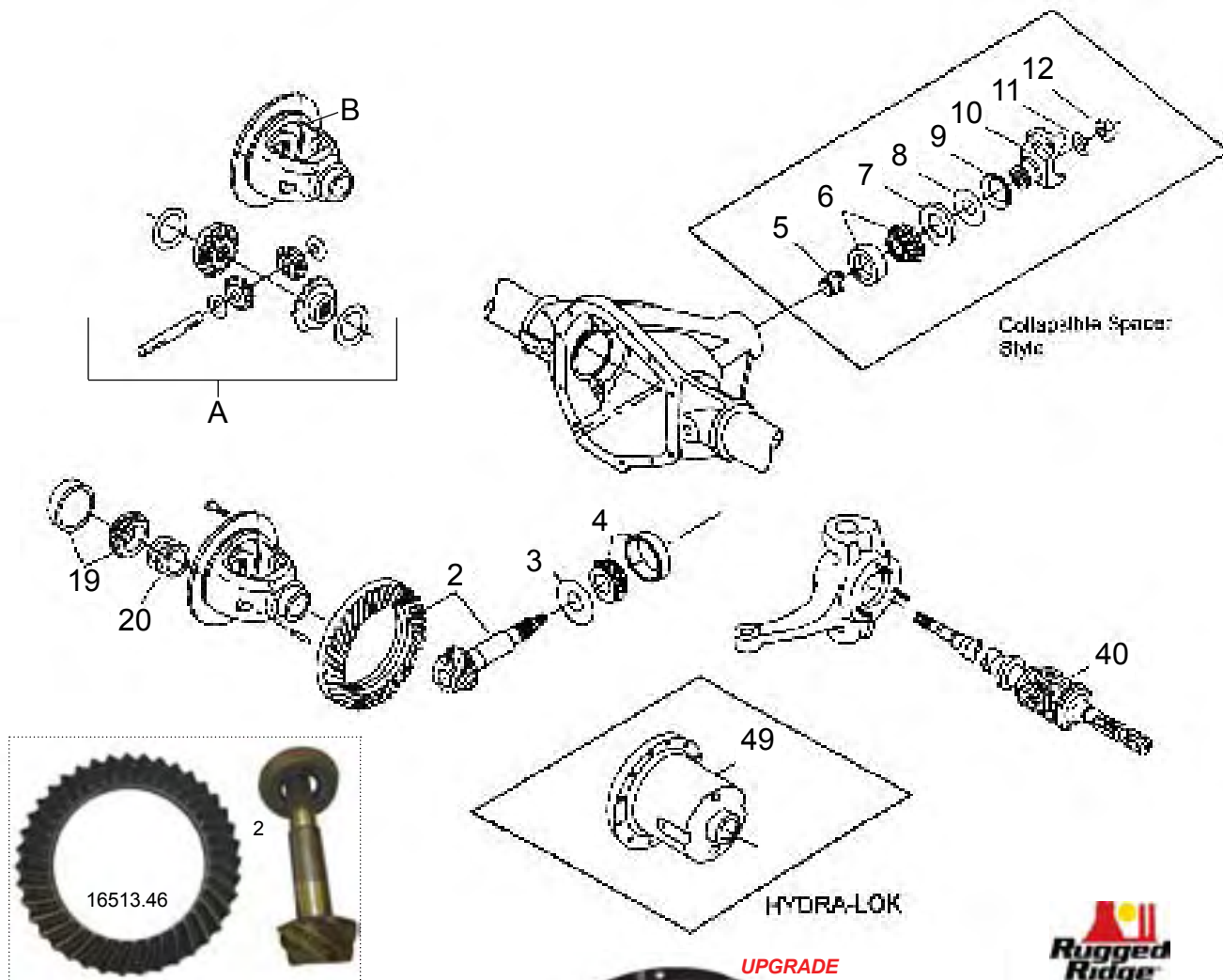

HEAVY DUTY DIFFERENTIAL COVERS
 You won't break these covers, we guarantee it, if you do, we'll replace them. Made of 3/8 inch cast steel, painted black inside and out, these heavy duty covers are designed to protect your differential and all its working parts for as long as you own your vehicle. these covers even have reinforced protection for the fill plug. All mounting hardware and instructions are included.



1999-04 GRAND CHEROKEE & 2002-07 LIBERTY DANA SUPER 30 / 186

DESCRIPTION	PART #	DESCRIPTION	PART #
2 RING & PINION KIT		40 AXLE SHAFTS	
3.55 RATIO (WJ)	16513.45	1999-04 GRAND CHEROKEE (w/o Hydra-Lok) RH	16523.30
3.73 RATIO (WJ)	16513.46	1999-04 GRAND CHEROKEE (w/o Hydra-Lok) LH	16523.31
3.91 RATIO (ring & pinion only) (WJ)	16513.47	1999-04 GRAND CHEROKEE (w/ Hydra-Lok) LH (NEW)	16523.37
3 PINION SHIM KIT, 2002-07 LIBERTY	16512.08	2002-07 LIBERTY, LH or RH	16523.43
4 INNER PINION BEARING KIT		FRONT AXLE ASSEMBLY, 1999-04 GRAND CHEROKEE	
1999-04 GRAND CHEROKEE	16515.02	WITHOUT VARIABLE LOCK, RH	16523.32
2002-07 LIBERTY	16512.68	WITHOUT VARIABLE LOCK, LH	16523.33
5 COLLAPSIBLE SPACER	16512.54	WITH VARIABLE LOCK, RH	16523.34
6 COLLAPSIBLE SPACER, 00-03 WJ (NEW)	16512.63	WITH VARIABLE LOCK, LH	16523.35
7 OUTER PINION BEARING KIT	16517.02	CV JOINT 1999-04 WJ	16523.23
8 SLINGER	16512.52	AXLE BEARING, 2002-07 LIBERTY	16536.32
9 SEAL PINION, INNER		AXLE OIL SEAL, 2002-07 LIBERTY	16534.12
1999-00 GRAND CHEROKEE	16521.03	AXLE SHAFT SEAL, 2002-07 LIBERTY	16534.13
2001-03 GRAND CHEROKEE	16521.15	AXLE SNAP RING, 2002-07 LIBERTY	16536.23
10 SEAL PINION, OUTER (WJ)	16521.04	A SPIDER GEAR SET (WJ)	16507.04
11 2002-07 LIBERTY (NEW)	16521.17	B CASE ASSEMBLY KIT (item B plus A)	
12 YOKE (WJ/KJ) (NEW)	16580.56	STANDARD 3.55 RATIO (WJ)	16505.07
13 PINION WASHER	16584.02	STANDARD 3.73 RATIO (WJ)	16505.08
14 PINION NUT	16584.01	CASE KIT (item A plus 20)	
15 DIFFERENTIAL BEARING KIT	16509.05	STANDARD 3.73 or 3.90 RATIO (WJ) (NEW)	16503.62
16 DIFFERENTIAL SHIM KIT (WJ)	16511.02	49 HYDRA-LOK, 3.73 RATIO & UP (WJ)	16505.09
17 DIFFERENTIAL BEARING CAP BOLT	16584.11	49a HYDRA-LOK AXLE PLENUM 1999-03 WJ (NEW)	16508.40
18 DIFFERENTIAL PARTS KIT, 2002-06 LIBERTY	16509.09	50 HEAVY DUTY DIFFERENTIAL COVER, 3/8" THICK CAST STEEL, WITH HARDWARE (UPGRADE)	16595.30
		51 HEAVY DUTY DIFFERENTIAL SKID PLATE, 3/8" THICK CAST STEEL, W/ HARDWARE (UPGRADE)	16597.30

REAR DANA-27 & REAR -44 W/ TAPERED AXLE



FITS 1941-47 MB & EARLY CJ-2A
(FULL FLOATING TYPE)



16507.01



16582.02

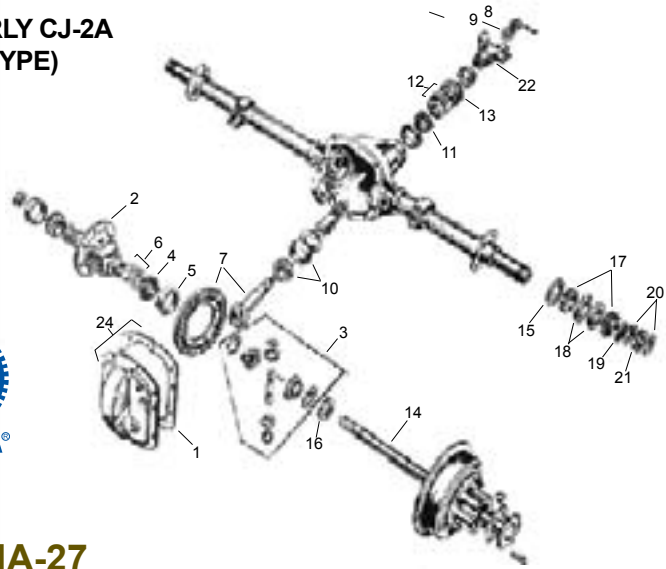

11118.02



REAR DANA-27

DESCRIPTION	PART #	DESCRIPTION	PART #
1 GASKET, AXLE COVER	16502.01	14 AXLE SHAFT PASSENGER SIDE (short)	16530.02
3 SPIDER GEAR KIT STANDARD DIFFERENTIAL	16507.01	15 OIL SEAL, REAR OUTER WHEEL	16708.01
4 BEARING, DIFFERENTIAL SIDE	16509.01	16 OIL SEAL, REAR INNER	16526.01
5 CUP, DIFFERENTIAL SIDE	16509.03	17 BEARING, AXLE SHAFT	16706.01
6 SHIM KIT DIFFERENTIAL SIDE BEARINGS	16511.01	18 BEARING CUP, AXLE SHAFT	16707.01
7 RING & PINION 4.88 RATIO 39X8	16513.02	19 LOCK WASHER, WHEEL BEARING	16710.02
8 PINION NUT	16584.01	20 NUT, WHEEL BEARING (each)	16710.03
9 PINION WASHER	16584.02	21 LOCK WASHER, WHEEL BEARING NUT	16710.04
10 INNER PINION BEARING & CUP KIT	16515.01	SPINDLE NUT & WASHER KIT (2 nuts & 2 washers)	16710.01
11 OUTER PINION BEARING & CUP KIT	16517.01	22 YOKE	16580.04
12 SHIM KIT PINION BEARING	16519.01	23 U-BOLT KIT PAIR FOR YOKE	16582.01
13 PINION OIL SEAL	16521.01	24 DIFFERENTIAL COVER KIT STAINLESS STEEL, INCLUDES GASKET & HARDWARE	16582.02
			11118.02

FITS 1948-69 CJ2A, CJ3A, CJ3B & CJ5 WITH TAPERED AXLE SHAFTS

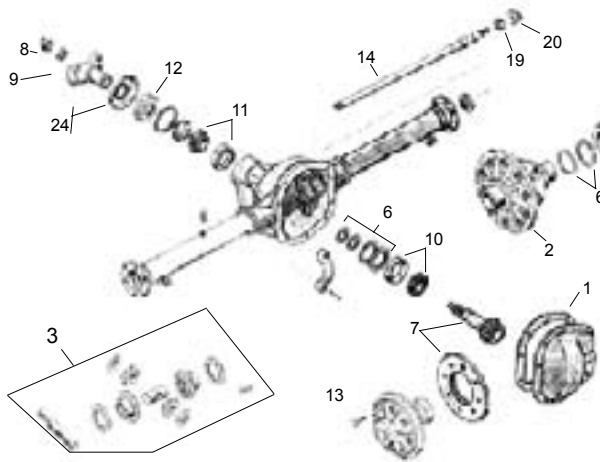

16513.61



16580.04

16530.03



11118.03



16582.02

REAR DANA-44 W/ TAPERED AXLE SHAFTS

DESCRIPTION	PART #	DESCRIPTION	PART #
1 GASKET, AXLE COVER	16502.02	14 AXLE SHAFT PASSENGER SIDE, 10 SPLINE	16530.04
2 CASE, STANDARD DIFFERENTIAL 3.92 TO 5.38 RATIO	16503.20	AXLE SHAFT PASSENGER SIDE, 19 SPLINE	16530.06
3 SPIDER GEAR KIT, STANDARD DIFFERENTIAL 10 SPLINE	16507.15	AXLE SHAFT DRIVER SIDE, 10 SPLINE	16530.03
19 SPLINE	16507.16	AXLE SHAFT DRIVER SIDE, 19 SPLINE	16530.05
4 BEARING, DIFFERENTIAL SIDE (2 needed)	16509.20	15 AXLE SHAFT NUT	16533.01
5 CUP, DIFFERENTIAL SIDE (2 needed)	16509.21	16 AXLE HUB KEY	16533.02
6 SHIM KIT, DIFFERENTIAL SIDE & PINION BEARING	16512.20	16 AXLE HUB KEY (OVERSIZED KEY, FOR USE WITH WORN OUT HUB KEY AREA)	16533.12
7 RING & PINION:		17 OIL SEAL, REAR OUTER AXLE	16534.01
5.38 RATIO, 43X8 TEETH 10 SPLINE	16513.60	18 OIL SEAL, REAR INNER AXLE	16535.01
4.27 RATIO, 47X11 TEETH 10 SPLINE	16513.61	19 BEARING, AXLE SHAFT	16536.01
3.73 RATIO, 41X11 TEETH 26 SPLINE	16513.62	20 CUP, AXLE SHAFT	16536.02
8 PINION NUT	16584.01	21 SHIM KIT REAR AXLE RETAINER	16533.03
9 PINION WASHER	16584.02	22 REAR AXLE HUB	16537.01
10 INNER PINION BEARING & CUP KIT	16515.01	23 WHEEL STUD, RIGHT THREAD, (each)	16714.03
11 OUTER PINION BEARING & CUP KIT	16517.01	24 YOKE 10 SPLINE	16580.04
12 PINION OIL SEAL	16521.01	YOKE 26 SPLINE	16580.02
13 BOLT FOR RING GEAR	16522.01	25 U-BOLT KIT FOR YOKE (pair)	16582.01
		U-BOLT KIT FOR YOKE (pair), SPICER BRAND	16582.02
		26 DIFFERENTIAL COVER KIT STAINLESS STEEL, INCLUDES GASKET & HARDWARE	11118.03

Axle & Differential

REAR DANA-44 WITH FLANGED AXLES

FITS 1972-75 CJ, 1986 CJ7 W/ DANA-44,
1987-10 WRANGLER W/ DANA-44
1987-01 CHEROKEE, 1993-04 GRAND

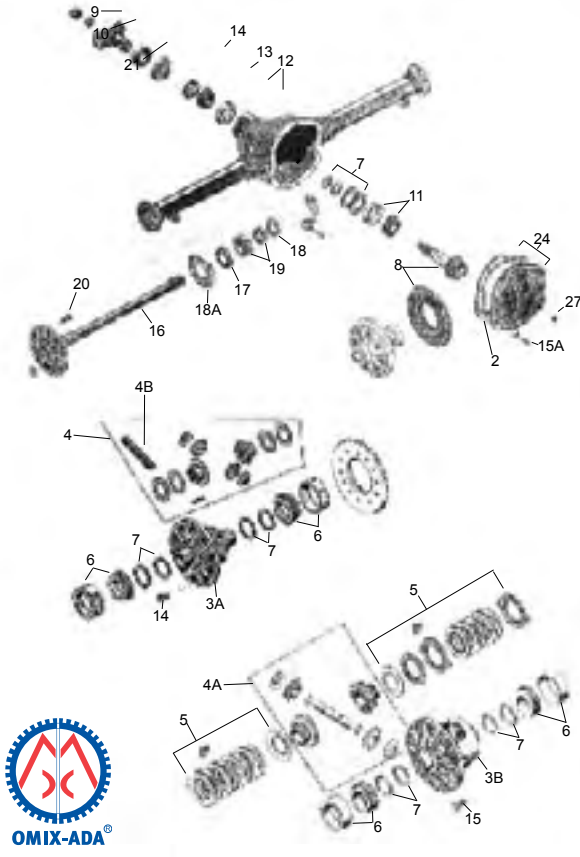

HEAVY DUTY DIFFERENTIAL COVERS
You won't break these covers, we guarantee it, if you do, we'll replace them. Made of 3/8" cast steel, painted black inside and out, these heavy duty covers are designed to protect your differential and all its working parts for as long as you own your vehicle. These covers even have reinforced protection for the fill plug. Mounting hardware & instructions included.

REAR DANA-44 WITH FLANGED AXLES

DESCRIPTION	PART #		DESCRIPTION	PART #
1 REBUILD KIT (bearings, seal, shims & hardware)	16501.04	2	10 PINION WASHER, 1970-00	16584.02
GASKET, AXLE COVER, 1970-00	16502.02		10 PINION THRUST WASHER, 2001-06	16584.09
2 GASKET, AXLE COVER, 2001-06	16502.05		11 INNER PINION BEARING & CUP KIT (all)	16515.01
3 CASE ASSEMBLY KIT, TRAC LOCK, 2003-06 TJ (NEW)	16503.50		12 OUTER PINION BEARING & CUP KIT (all)	16517.01
3A CASE, STANDARD DIFFERENTIAL (with gasket & bolts)			13 OUTER PINION BEARING SLINGER (all)	16512.52
2.87 TO 3.73:1, CJ ONLY	16503.25		COLLAPSIBLE PINION SPACER (NEW)	16512.67
3.92 TO 5.38:1, CJ ONLY	16503.26		14 PINION OIL SEAL, CJ ONLY	16521.01
3.54:1 1987-95 WRANGLER	16505.13		PINION OIL SEAL, CJ ONLY, NATIONAL BRAND	16521.02
3.73:1, 2001-03 WRANGLER	16503.65		PINION OIL SEAL, WRANGLER ONLY	16521.08
3B CASE, TRAC LOCK DIFFERENTIAL (with gasket & bolts)			PINION OIL SEAL, FLANGED, 01-06 WRANGLER (NEW)	16521.12
2.87 TO 3.73:1, CJ ONLY	16503.27		15 BOLT RING GEAR (all)	16522.01
3.92 TO 5.38:1, CJ ONLY	16503.28		15A DIFFERENTIAL COVER BOLT, DANA-30, 35, 44, AMC-20	16522.02
3.07 TO 3.54:1 1987-95 WRANGLER	16505.10		16 AXLE SHAFTS	
3.07, 3.53, 3.73 & 4.10:1, WRANGLER ONLY	16503.27		1972-75 CJ ONLY, LH OR RH	16530.07
4.10, 4.56:1, WRANGLER RUBICON	16505.27		1972-75 CJ ONLY, LH OR RH (w/ bearing, retainers, oil seals, studs)	16530.08
4 SPIDER GEAR KIT STANDARD DIFF., CJ ONLY	16507.17		1987-95 WRANGLER, PASSENGER SIDE (NEW)	16530.18
4 SPIDER GEAR KIT STANDARD DIFF., TJ 01-06 (NEW)	16509.07		1997-02 WRANGLER, NON ABS, DRIVER SIDE	16530.09
4A SPIDER GEAR KIT TRAC-LOC (with disc kit), CJ ONLY	16507.18		1997-02 WRANGLER, NON ABS, PASSENGER SIDE	16530.10
SPIDER GEAR KIT TRAC-LOC (w/ disc kit), WRANGLER ONLY	16507.19		1994-98 GRAND CHEROKEE, PASSENGER SIDE	16530.12
SPIDER GEAR KIT TRAC-LOC, 2001-06 WRANGLER	16509.08		1994-98 GRAND CHEROKEE, DRIVER SIDE	16530.11
5 TRAC LOC DISC KIT (all)	16508.01		1999-04 GRAND CHEROKEE, PASSENGER SIDE	16530.14
6 BEARING & CUP KIT, DIFFERENTIAL SIDE			1999-04 GRAND CHEROKEE, DRIVER SIDE	16530.13
(2 bearings + 2 cups) (all)	16509.22		2003 WRANGLER w/ 3.07:1, DRIVER SIDE	16523.47
7 SHIM KIT, PINION BEARING, 2007-10 WRANGLER			2003 WRANGLER w/ 3.07:1, PASSENGER SIDE	16523.48
0.035-0.039" (NEW)	16519.02		2003-06 WRANGLER, 3.07, 3.73 with Trac Lok, LH	16523.45
0.040-0.044" (NEW)	16519.03		2003-06 WRANGLER, 3.07, 3.73 with Trac Lok, RH	16523.44
0.045-0.049" (NEW)	16519.04		2002-06 WRANGLER, 4.10 with Trac Lok, LH (NEW)	16530.15
0.050-0.054"	16519.05		2002-06 WRANGLER, 4.10 with Trac Lok, RH (NEW)	16530.16
7 SHIM KIT, PINION BEARING, 25-PCS, 2003-06 WRANGLER	16519.06		17 OIL SEAL, REAR OUTER AXLE (ALL EXCEPT 07-10 JK)	16534.02
7 SHIM KIT, DIFFERENTIAL SIDE, 2001-03 WRANGLER	16512.07		17 OIL SEAL, REAR OUTER AXLE, 2007-10 WRANGLER (NEW)	16534.14
7 SHIM KIT, DIFFERENTIAL SIDE & PINION BEARING	16512.20		18 OIL SEAL, REAR INNER AXLE, 1970-75 CJ ONLY	16535.02
7 2003-06 WRANGLER WITH 4.89 GEARS	16519.08		18a AXLE SHAFT RETAINER PLATE (NEW)	16536.38
8 RING & PINION KITS:			19 BEARING & CUP W/ RETAINER, AXLE SHAFT (all)	16536.05
3.31:1 (bearings, shims, seals & hardware)	16513.65		20 WHEEL STUD, RIGHT THREAD (each)	
3.54:1, (bearings, shims, seals & hardware), CJ ONLY	16513.66		CJ ONLY	16714.06
3.54:1 (nut, washer & bolts) 1987-93 XJ (NEW)	16514.32		WRANGLER WITH DRUM BRAKES ONLY	16714.08
3.55:1, (bearings, shims, seals & hardware), WRANGLER ONLY	16513.67		WRANGLER WITH DISC BRAKES ONLY	16714.09
3.73:1, (nut, washer & bolts), ALL CJ & WRANGLER	16513.62		21 YOKE 26 SPLINE	
4.09:1, (bearings, shims, seals & hardware), CJ ONLY	16513.68		CJ ONLY (U-bolt style)	16580.02
4.09:1, (nut, washer & bolts) 1987-93 CHEROKEE (NEW)	16514.31		1997 WRANGLER ONLY (strap & bolt design)	16580.07
4.09:1, (nut, washer & bolts) 1991-95 WRANGLER (NEW)	16514.31		1998-06 WRANGLER ONLY (strap & bolt design)	16580.15
4.10:1, (nuts & bolts only), WRANGLER ONLY	16513.69		22 U-BOLT KIT (pair) FOR 16580.02, CJ ONLY	16582.01
4.27:1, (nut, washer & bolts), CJ ONLY	16513.70		SPICER BRAND	16582.02
4.55:1, (bearings, shims, seals & hardware), CJ ONLY	16513.71		23 STRAP & BOLT KIT, FOR WRANGLER	16582.03
4.89:1, (nut, washer & bolts) CJ ONLY	16513.72		24 DIFFERENTIAL COVER, 2001-06 WRANGLER (NEW)	16595.83
4.89:1, (nut, washer & bolts) 2003-06 WRANGLER	16513.75		24 DIFFERENTIAL COVER KIT, 2001-06 WRANGLER (NEW)	16595.85
5.38:1, (nut, washer & bolts), CJ ONLY	16513.73		24 DIFFERENTIAL COVER, 1991-02, 2003-04 W/O TRULOK,	
8a RING & PINION GEARS ONLY:			2005-06 WITHOUT REAR DISC BRAKES	16595.86
3.07:1 2001-03 WRANGLER WITH TRAC LOK	16514.41		24 DIFFERENTIAL COVER KIT STAINLESS STEEL,	
3.07:1 2003-06 WRANGLER WITH TRAC LOK	16514.51		INCLUDES GASKET & HARDWARE	11118.03
3.73:1 2003-06 WRANGLER WITH TRAC LOK	16514.55		25 HEAVY DUTY DIFFERENTIAL COVER, 3/8" THICK	
4.10:1 2003-06 WRANGLER W/ TRAC LOK / AIR LOCKER	16514.43		CAST STEEL, WITH HARDWARE (UPGRADE)	16595.44
9 PINION NUT (all except 2002-06 WRANGLER)	16584.01		26 HEAVY DUTY DIFFERENTIAL SKID PLATE, 3/8"	
PINION NUT, 2002-06 WRANGLER (NEW)	16584.04		THICK CAST STEEL, WITH HARDWARE (UPGRADE)	16597.44
			27 DIFFERENTIAL COVER PLUG, 2003-06 WRANGLER (NEW)	16595.96

Axle & Differential

REAR AMC MODEL-20

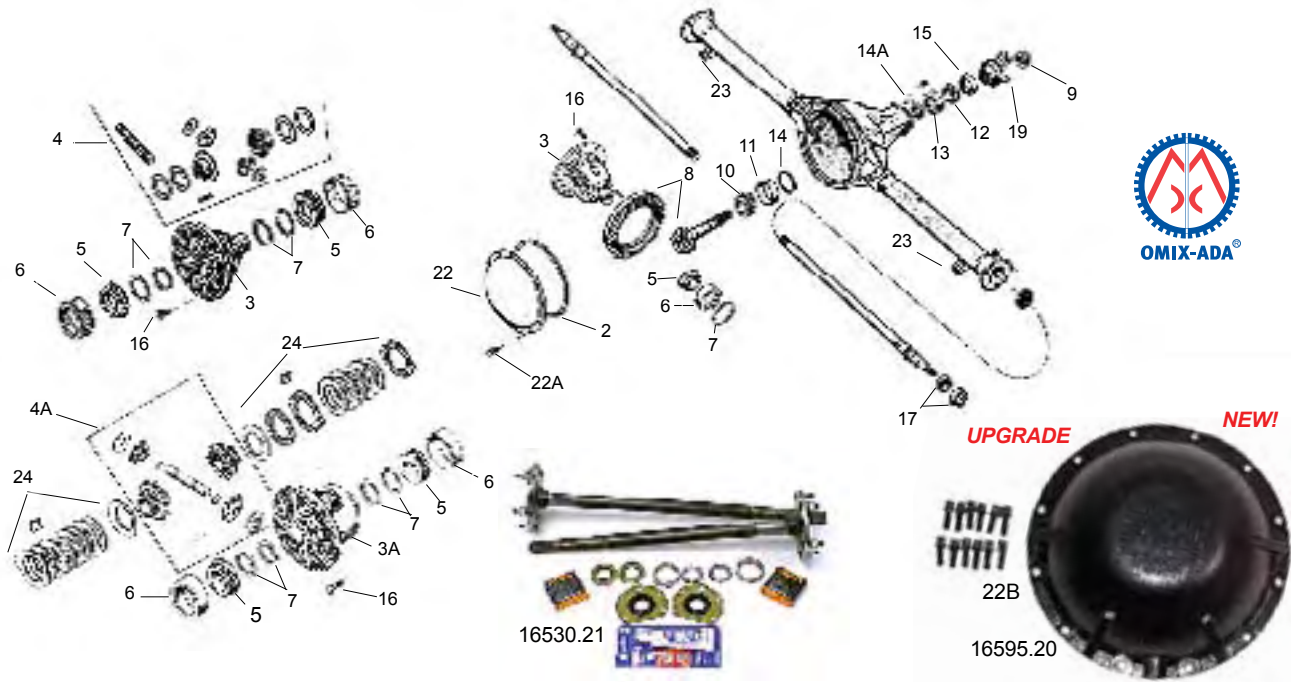

1976-86 CJ REAR AMC MODEL-20

DESCRIPTION	PART #	DESCRIPTION	PART #
1 AMC-20 REBUILD KIT (bearings, seals, hardware) (shims not included)	16501.05	11 INNER PINION CUP	16515.21
2 GASKET, AXLE COVER	16502.03	12 OUTER PINION BEARING	16517.20
3 CASE, STANDARD DIFF. ALL EXCEPT 2.73 RATIO	16503.31	13 OUTER PINION CUP	16517.21
4A SPIDER GEAR KIT TRAC-LOC DIFF	16507.23	14A SPACER, COLLAPSIBLE PINION	16512.60
5 BEARING, DIFFERENTIAL SIDE (2 needed)	16509.25	15 PINION OIL SEAL W/O PINION NUT	16521.07
6 CUP, DIFFERENTIAL SIDE (2 needed)	16509.26	17 BEARING & CUP W/ RETAINER, AXLE SHAFT	16536.15
8 RING & PINION (ring & pinion only)		18 WHEEL STUD, RIGHT THREAD (each)	16714.06
3.31 RATIO 43X13 TEETH	16513.81	19 YOKE, U-BOLT DESIGN	16580.05
3.54 RATIO 39X11 TEETH	16513.82	YOKE, STRAP & BOLT DESIGN	16580.16
3.73 RATIO 41X11 TEETH	16513.83	20 U-BOLT KIT (pair) FOR O.E YOKE	16582.01
4.10 RATIO 41X10 TEETH	16513.84	21 U-BOLT KIT (pair) FOR O.E YOKE, SPICER BRAND STRAP & BOLT KIT FOR 16580.16	16582.02
4.56 RATIO 41X9 TEETH	16513.85	22 DIFFERENTIAL COVER KIT, STAINLESS STEEL, WITH GASKET & HARDWARE	11118.04
4.88 RATIO	16513.86	22B HEAVY DUTY DIFFERENTIAL COVER, 3/8" THICK CAST STEEL, WITH HARDWARE (UPGRADE)	16595.20
9 PINION NUT	16584.03	22A DIFF COVER BOLT, DANA-30, 35, 44, AMC-20	16522.02
10 INNER PINION BEARING	16515.20	23 AXLE HOUSING SPRING PAD SET (pair)	16527.40
		24 DISC KIT FOR TRAC-LOC IN AMC-20	16508.05
		YOKE KIT AMC 20, JEEP CJ5 76-81, CJ7 76-86, CJ8 82-86 (NEW)	16580.26

1 PIECE AXLE CONVERSION KITS:

1-PIECE AXLE KITS FEATURING TIMKEN SET-9 BEARINGS. KIT INCLUDES LEFT & RIGHT PAIR (one kit required per vehicle) UNLESS OTHERWISE NOTED. KIT INCLUDES: 1 LEFT AXLE, 1 RIGHT AXLE, 2 TIMKEN SET-9 BEARINGS, 2 BEARING RETAINERS, 2 SPACERS, 2 INNER OIL SEALS, 2 OUTER OIL SEALS, 10 STUDS, SILICONE SEALANT & DETAILED INSTRUCTIONS. (See Limited Warranty terms). ONE-PIECE KITS ARE ALSO AVAILABLE WITH GREEN BRAND BEARINGS. PLEASE USE 16530.41, 16530.42, 16530.43 FOR KITS WITH GREEN BEARINGS

DESCRIPTION	PART #
NARROW-TRACK 1976-83 CJ5, 1976-81 CJ7, 1981 CJ8 (without Quadtrac)	16530.20
WIDE-TRACK 1982-86 CJ7, 1982-86 CJ8	16530.21
QUADRATRAC 1976-79 CJ7, WITH FACTORY T-400 AUTOMATIC TRANSMISSION	16530.22
NARROW-TRACK 1976-83 CJ5, 1976-81 CJ7, 1981 CJ8 (W/O QUADRATRAC), DRIVER SIDE ONLY	16530.37
NARROW-TRACK 1976-83 CJ5, 1976-81 CJ7, 1981 CJ8 (W/O QUADRATRAC), PASSENGER SIDE ONLY	16530.38
QUADRATRAC 1976-79 CJ7, WITH FACTORY T-400 AUTOMATIC TRANNY, DRIVER SIDE ONLY	16530.39
QUADRATRAC 1976-79 CJ7, WITH FACTORY T-400 AUTOMATIC TRANNY, PASSENGER SIDE ONLY	16530.40
SPARE BEARINGS & HARDWARE KIT (both sides)	16536.06
SPARE BEARINGS & HARDWARE KIT (one side)	16536.07
SPARE BEARING (each)	16536.08
SPARE BEARING RETAINER (each)	16536.09
SPARE SPACER (each)	16536.10
SPARE INNER OIL SEAL (each)	16535.03
SPARE OUTER OIL SEAL (each)	16534.03
SEALED WHEEL BEARING KIT (NEW)	16560.59

REPLACEMENT 2 PIECE AXLE KITS, HUBS & COMPONENTS:

2-PIECE STOCK REPLACEMENT AXLE SHAFT KITS (kits are per side). EACH KIT INCLUDES: 1 AXLE SHAFT, 1 HUB, 1 BEARING, 1 CUP, 1 INNER OIL SEAL, 1 OUTER OIL SEAL & NUT, WASHER & KEY KIT.

DESCRIPTION	PART #
1976-83 CJ 5, 1976-81 CJ7 & CJ8 (w/o Quadtrac)	
26.25", LH SHAFT	16530.25
26.25", LH KIT	16530.27
29.25", RH SHAFT	16530.26
29.25", RH KIT	16530.28
1982-86 CJ7 & CJ8, 28.5", LH SHAFT	16530.29
1982-86 CJ7 & CJ8, 28.5", LH KIT	16530.31
1982-86 CJ7 & CJ8, 31.5", RH SHAFT	16530.30
1982-86 CJ7 & CJ8, 31.5", RH KIT	16530.32
1976-79 CJ7 WITH QUADRATRAC, 33.5", LH SHAFT	16530.33
1976-79 CJ7 WITH QUADRATRAC, 33.5", LH KIT	16530.35
1976-79 CJ7 WITH QUADRATRAC, 22", RH SHAFT	16530.34
1976-79 CJ7 WITH QUADRATRAC, 22", RH KIT	16530.36
1976-86 HUB WITH STUDS (for all above models)	16537.02
1976-86 HUB KIT (with bearing, cup, 2 oil seals, nut, washer & key)	16537.03
1976-86 AXLE SHAFT BEARING & CUP (one of each)	16536.15
1976-86 INNER AXLE OIL SEAL (each)	16535.03
1976-86 OUTER AXLE OIL SEAL (each)	16534.03
1976-86 AXLE NUT-WASHER-KEY KIT (each side)	16533.04
1976-86 REAR AXLE SHIM, 0.0003"	16533.05
1976-86 REAR AXLE SHIM, 0.010"	16533.06
1976-86 REAR AXLE SHIM KIT (one 0.003" & one 0.010")	16533.07
1976-86 OUTER AXLE DUST SHIELD (each side)	16533.08
1976-80 METAL DUST CAP	16533.09
1981-86 DUST CAP, PLASTIC	16533.10

5 YEAR LIMITED WARRANTY TO ORIGINAL CONSUMER ON 16530.20, 16530.21 & 16530.22 AMC ONE-PIECE AXLE KITS WITH TIMKEN BRAND BEARINGS.

REAR DANA-35

FITS 1987-10 WRANGLER, 1984-01 CHEROKEE, 1993-04 GRAND CHEROKEE

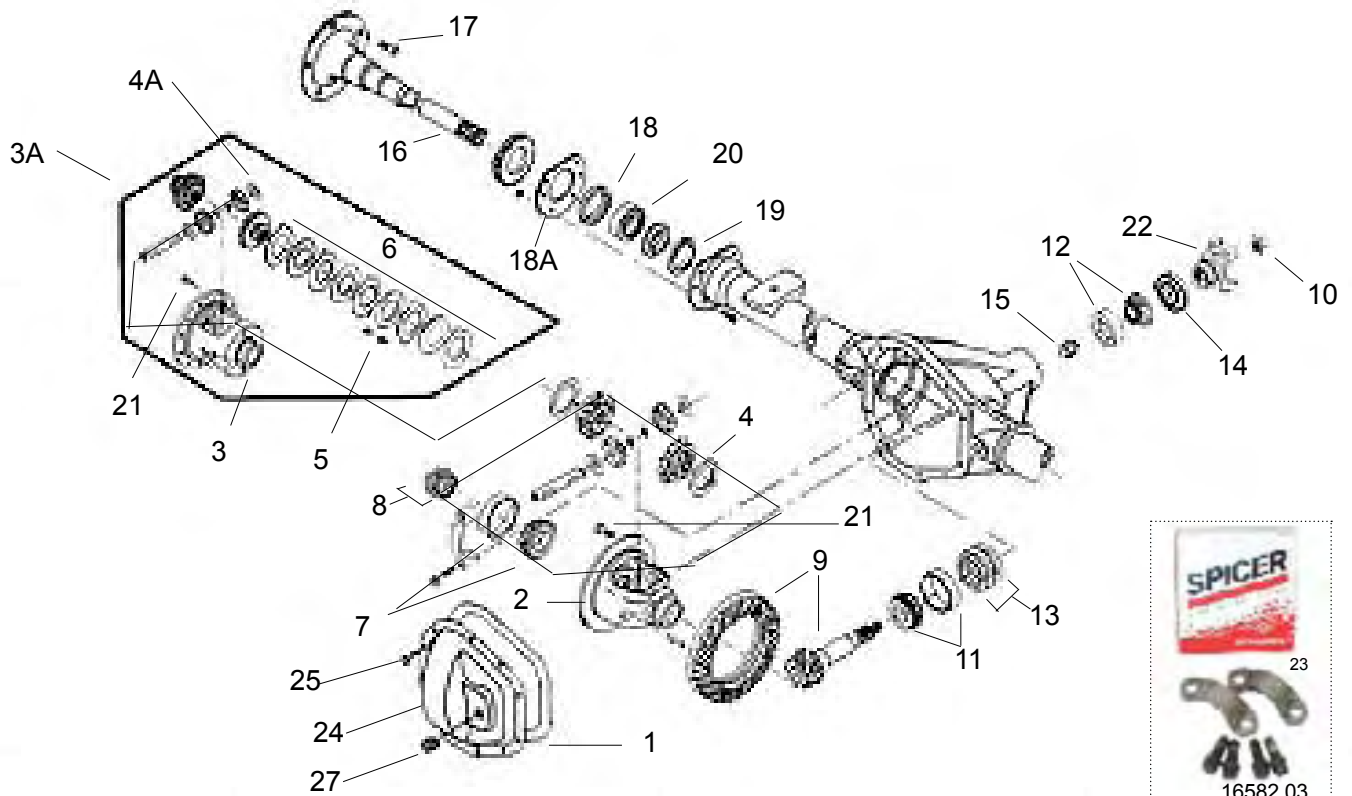

UPGRADE



UPGRADE



CHRYSLER 8.25" & MISC. JEEP® PARTS



MISC. AXLE COMPONENTS

DESCRIPTION	PART #
AXLE BEARING KIT, CHRYSLER 8.25", 1991-01 CHEROKEE	16501.07
AXLE REBUILD KIT 8.25", 91-01 CHEROKEE	16501.08
RING & PINION, 8.25", 3.55, 91-01 CHEROKEE	16514.56
RING & PINION, 8.25", 4.10, 91-01 CHEROKEE	16514.57
AXLE SEAL OUTER, 68-70 JEEP PICKUP (NEW)	16534.35
JEEP® CHEROKEE AXLE SHAFT (XJ) 91-96, LH/RH, CHRYSLER 8.25", 27-SPLINE	21116
JEEP® CHEROKEE AXLE SHAFT (XJ) 97-01, LH/RH, CHRYSLER 8.25", 29-SPLINE	21118

FITS 1987-10 WRANGLER, 1984-01 CHEROKEE, 1993-04 GRAND CHEROKEE



DESCRIPTION	PART #	DESCRIPTION	PART #
1 GASKET, SILICON TUBE	19201.01	10 PINION NUT	16584.03
GASKET, EXACT CUT	16502.04	11 INNER PINION BEARING & CUP KIT	16515.15
1A REBUILD KIT (bearings, seal, shims & hardware)		12 OUTER PINION BEARING & CUP KIT	16517.02
ALL EXCEPT 1999-04 GRAND CHEROKEE	16501.06	PINION THRUST WASHER, 99-02 (NEW)	16584.07
1999-04 GRAND CHEROKEE (NEW)	16501.09	13 PINION BEARING SHIM SET	
2 DIFFERENTIAL CASE, STANDARD		1984-06 ALL EXCEPT 2007-10 WRANGLER	16519.10
1987-93, 2.73 TO 3.31 RATIO,		2007-10 WRANGLER, 0.035-0.039" (NEW)	16519.02
(not for 1993 WRANGLER BOM 605528)	16503.40	2007-10 WRANGLER, 0.040-0.044" (NEW)	16519.03
1994-00, 2.73 TO 3.31 RATIO Wrangler & Cherokee	16503.41	2007-10 WRANGLER, 0.045-0.049" (NEW)	16519.04
1993 WRANGLER w/ 605528 BOM, 2.73-3.31 RATIO	16503.41	2007-10 WRANGLER, 0.050-0.054"	16519.05
1987-89, 3.55 TO 4.56 RATIO (SPICER #41993)	16503.42	14 INNER PINION OIL SEAL	
1990-93, 3.55-4.56 (except 93 WRANGLER w/		1987-06 WRANGLER	16521.10
BOM 605528)	16503.43	1999-01 CHEROKEE	16521.16
1994-00, 3.55 TO 4.56 RATIO	16503.44	1999-03 GRAND CHEROKEE	16521.16
1993 WRANGLER w/ 605528 BOM, 1999-04 3.55-4.56	16503.44	OUTER PINION OIL SEAL	
3.07 RATIO 2001-02 WRANGLER	16503.66	1999-01 CHEROKEE (NEW)	16521.13
2A CASE ASSEMBLY KIT, STANDARD DIFFERENTIAL		1999-03 GRAND CHEROKEE (NEW)	16521.13
2.73-3.07 RATIO 1986-93, SPICER	16505.22	15 COLLAPSIBLE PINION SPACER	
3.07 RATIO 1994-95 WRANGLER	16505.23	1987-95 WRANGLER	16512.59
3.07 RATIO 2001 CHEROKEE	16505.11	2007-10 WRANGLER (NEW)	16512.67
3.07 RATIO 2001-02 WRANGLER	16505.11	1984-01 CHEROKEE	16512.59
3.31-4.56 RATIO 1987-93 WRANGLER	16505.20	1993-98 GRAND CHEROKEE all	16512.59
3.31-4.56 RATIO 1987-93 CHEROKEE	16505.20	2003-04 GRAND CHEROKEE w/ 3.55	16512.59
3.55-4.56 RATIO 1992-94 CHEROKEE, SPICER	16505.21	1999-04 GRAND CHEROKEE w/ 3.73 (NEW)	16512.64
3.55-4.56 RATIO 1994-06 WRANGLER	16505.24	1999-02 GRAND CHEROKEE w/ 3.55 (NEW)	16512.64
3.55-4.56 RATIO 1994-01 CHEROKEE	16505.24	16 AXLE SHAFTS:	
3.55-4.56 RATIO 1994-98 GRAND CHEROKEE	16505.24	1984-89 CHEROKEE DRIVER SIDE	16530.51
3.55-3.73 RATIO 1999-04 GRAND CHEROKEE	16505.25	1984-89 CHEROKEE PASSENGER SIDE	16530.50
3.55 RATIO 2001 CHEROKEE W/ TRAC LOK	16505.19	1987-89 WRANGLER DRIVER SIDE	16530.51
3.73 RATIO 2001-02 WRANGLER W/ TRAC LOK	16505.17	1987-89 WRANGLER PASSENGER SIDE (shaft only)	16530.50
4.11 RATIO 2001-02 WRANGLER W/O TRAC LOK	16505.19	1990-02 (all) PASS. SIDE W/O ABS (C-clip style)	16530.52
4.56 RATIO 2002 WRANGLER	16505.19	1990-02 (all) DRIVER SIDE W/O ABS (C-clip style)	16530.53
3 CASE ONLY, TRAC-LOK,		1990-91 WRANGLER, PASS. SIDE WITH ABS	16530.54
3.07 RATIO 1997-01 CHEROKEE (NEW)	16503.60	1990-91 CHEROKEE, PASS. SIDE WITH ABS	16530.54
3.07 RATIO 1997-01 WRANGLER (NEW)	16503.60	1990-91 WRANGLER, DRIVER SIDE WITH ABS	16530.55
3.55-4.56 RATIO, 1987-00 (will not fit 92-93 WRANGLER)	16503.48	1990-91 CHEROKEE, DRIVER SIDE WITH ABS	16530.55
3.73-4.56 RATIO 2001-02 WRANGLER (NEW)	16503.63	1992-02 WRANGLER W/ ABS (w/ drum brake), RH	16530.56
4.55 RATIO 2001 CHEROKEE (NEW)	16503.63	1992-02 WRANGLER W/ ABS (w/ drum brake), LH	16530.57
3A CASE ASSEMBLY WITH GEAR KIT, TRAC-LOK		1992-01 CHEROKEE W/ ABS (w/ drum brake), RH	16530.56
1987-00, 2.73-3.31 (will not fit 1992-93 WRANGLER)	16505.29	1992-01 CHEROKEE W/ ABS (w/ drum brake), LH	16530.57
1987-00, 3.55-4.56 (will not fit 1992-93 WRANGLER)	16505.30	1993-98 GRAND CHEROKEE W/ ABS	
TRAC-LOK CASE ASSEMBLY KIT		(w/ brake drum), RH	16530.56
1999-04 GRAND CHEROKEE	16505.31	1993-98 GRAND CHEROKEE W/ ABS	
2001 CHEROKEE, 3.07:1 (NEW)	16503.51	(w/ brake drum), LH	16530.57
2001-02 WRANGLER, 3.07:1 (NEW)	16503.51	1994-98 GRAND CHEROKEE W/ ABS	
4 SPIDER GEAR KIT		(w/ rear disc brake), RH	16530.58
1987-93, STANDARD DIFFERENTIAL		1994-98 GRAND CHEROKEE W/ ABS	
(not for 1993 WRANGLER 605528)	16507.30*	(w/ rear disc brake), LH	16530.59
1994-00 W/ STANDARD DIFFERENTIAL	16507.31*	1999-04 GRAND CHEROKEE, RH	16530.60
1993 WRANGLER 605528 BOM W/ STANDARD DIFF	16507.31*	1999-04 GRAND CHEROKEE, LH	16530.61
1997-02 W/ TRAC-LOK DIFFERENTIAL (NEW)	16509.06*	2003-06 WRANGLER W/ ABS (w/ drum brake), RH (NEW)	16530.62
4A DIFFERENTIAL PINION THRUST WASHER, 99-03 (NEW)	16584.06	2003-06 WRANGLER W/ ABS (w/ drum brake), LH (NEW)	16530.63
5 1987-06 SPIDER GEAR KIT WITH DISC KIT		2003-06 WRANGLER W/ ABS (w/ disk brake), RH (NEW)	16530.64
TRAC-LOK DIFFERENTIAL	16507.32	2003-06 WRANGLER W/ ABS (w/ disk brake), RH (NEW)	16530.65
1990-02 TRAC-LOK DISC KIT	16508.11	16A C-CLIP	
7 BEARING & CUP KIT, DIFFERENTIAL CASE		1991-00	16533.20
(2 bearings & 2 cups)	16509.05	17 WHEEL STUD (with drum brakes)	16714.08
8 SHIM KIT DIFFERENTIAL SIDE	16511.10	WHEEL STUD (with disc brakes)	16714.09
9 RING & PINION KIT: (w/ bearings, cups, shims, seals & hardware)		18 AXLE OIL SEAL, OUTER 1984-86 CHEROKEE	16534.10
3.07 RATIO 43X14 TEETH	16514.01	AXLE OIL SEAL, OUTER 1987-89 WRANGLER	16534.10
3.55 RATIO 39X11 TEETH 1987-93 WRANGLER	16514.02	AXLE OIL SEAL, OUTER 1990-00 ALL (each)	16534.11
3.55 RATIO 39X11 TEETH 1994-06 WRANGLER	16514.03	AXLE OIL SEAL, OUTER 2007-10 WRANGLER (NEW)	16534.14
3.55 RATIO 39X11 TEETH 1994-01 CHEROKEE	16514.03	18A RETAINER	
3.55:1 39X11 TEETH 1994-98 GRAND CHEROKEE	16514.03	1984-89 WRANGLER	16536.20
3.73 RATIO 1994-06 WRANGLER	16514.04	CHEROKEE	16536.20
3.73 RATIO 1994-01 CHEROKEE	16514.04	1993-04 GRAND CHEROKEE (NEW)	16536.39
3.73 RATIO 1994-98 GRAND CHEROKEE	16514.04	19 AXLE OIL SEAL, INNER, 1984-89 CHEROKEE	16535.10
4.11 RATIO, 37X9 TEETH 1997-01 WRANGLER	16514.05	AXLE OIL SEAL, INNER, 1987-89 WRANGLER	16535.10
4.56 RATIO, 41X9 TEETH 1990-02 WRANGLER	16514.06	20 WHEEL BEARING:	
4.56 RATIO, 41X9 TEETH 2002 WRANGLER (NEW)	16514.37	1984-89 CHEROKEE, BEARING CUP &	
9a RING & PINION GEARS ONLY		RETAINER (each side)	16536.21
3.07:1 2001 CHEROKEE, REAR	16514.52	1987-89 WRANGLER, BEARING CUP &	
3.07:1 2001-02 WRANGLER, REAR	16514.52	RETAINER (each side)	16536.21
3.55:1 1999-04 GRAND CHEROKEE	16514.08	1990-06 ALL, BEARING (each side)	16536.22
3.55:1 1999-00 GRAND CHEROKEE, REAR	16514.46	21 RING GEAR BOLT (each)	16522.01
3.55:1 2001 CHEROKEE, REAR	16514.46	RING GEAR BOLT SET (NEW)	16521.81
3.73:1 1999-03 GRAND CHEROKEE, REAR W/		DIFF COVER BOLT, DANA-30, 35, 44, AMC-20	16522.02
TRAC LOK	16514.48	1987-93 WRANGLER, YOKE (strap & bolt design)	16580.20
3.73:1 1999-03 CHEROKEE REAR W/ TRAC LOK	16514.48	1996-97 WRANGLER, YOKE (strap & bolt design)	16580.20
3.73:1 1999-04 GRAND CHEROKEE	16514.09	1994-96 WRANGLER, YOKE (use with 3-5/8" U-joints)	16580.21
3.73:1 2001 CHEROKEE DIESEL, REAR	16514.49	1997-06 WRANGLER, YOKE (use with 3-7/32" U-joints)	16580.22
3.73:1 2001-02 WRANGLER REAR	16514.49	1987-93 WRANGLER, U-BOLT DESIGN YOKE KIT	16580.23
4.11:1 2001-02 WRANGLER REAR	16514.54	1997-02 WRANGLER, U-BOLT DESIGN YOKE KIT	16580.23
4.88:1 1990-02 WRANGLER	16514.07	2001 CHEROKEE W/ ABS, YOKE (NEW)	16580.62
*All spider gears must be replaced at once due to differences in manufacturing processes.		YOKE KIT DANA 35, JEEP WRANGLER (YJ) 87-93,	
		(TJ) 97-02, CHEROKEE (XJ) 84-95 (NEW)	16580.28
		23 STRAP & BOLT KIT	16582.03
		1991-04 DANA-35, CROSS SHAFT LOCKING BOLT	16507.33
		24 DIFFERENTIAL COVER KIT STAINLESS STEEL	
		W/ GASKET & HARDWARE	11118.05
		24A HEAVY DUTY DIFFERENTIAL COVER, 3/8" THICK	
		CAST STEEL, WITH HARDWARE (UPGRADE)	16595.35
		25 DIFFERENTIAL COVER BOLT	16522.02
		26 HEAVY DUTY DIFFERENTIAL SKID PLATE, 3/8"	
		THICK CAST STEEL, WITH HARDWARE (UPGRADE)	16597.35
		27 DIFFERENTIAL COVER PLUG (NEW)	16595.97

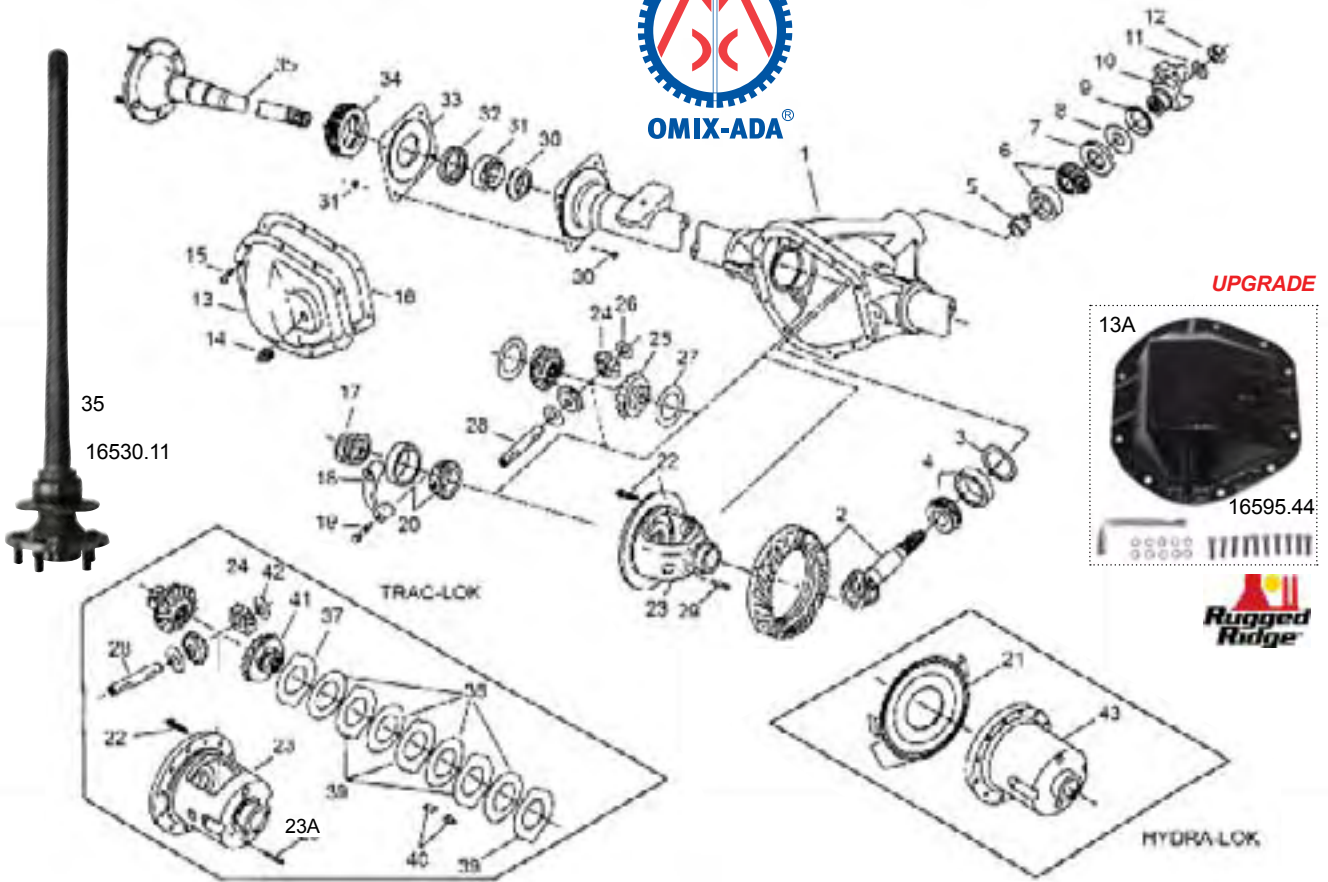

1996-04 GRAND CHEROKEE REAR DANA-44

DESCRIPTION	1996-98 PART #	1999-04 PART #
1 DIFFERENTIAL REBUILD KIT, 99-00, REAR (NEW)	----	16501.10
1 DIFFERENTIAL REBUILD KIT, 00-04, REAR (NEW)	----	16501.11
2 RING & PINION ONLY, 3.55 RATIO	16514.20	----
2 RING & PINION KIT, 3.55 RATIO (NEW)	----	16514.34**
2 RING & PINION ONLY 3.73 RATIO	16514.21	16514.25*
2 RING & PINION KIT, 3.73 RATIO (NEW)	----	16514.33*
2 RING & PINION KIT, 3.73 RATIO	----	16514.40**
2 RING & PINION KIT, 3.91 RATIO (NEW)	----	16514.35**
2 RING & PINION ONLY, 3.91 RATIO	----	16514.26*
4 INNER PINION BEARING KIT	16515.26	16515.26
5 COLLAPSIBLE SPACER	16512.62	16512.62
6 OUTER PINION BEARING SET	16517.30	16517.30
7 PINION THRUST WASHER (NEW)	----	16584.08
8 PINION OIL SEAL INNER	16521.30	16521.31
8 PINION OIL SEAL INNER, 01-03 W/ STD. DIFF (NEW)	----	16521.14
8 PINION OIL SEAL INNER, 99-00 (NEW)	----	16521.21*
8 PINION SHIM KIT, 0.035-0.039" (NEW)	----	16519.02
8 PINION SHIM KIT, 0.040-0.044" (NEW)	----	16519.03
8 PINION SHIM KIT, 0.045-0.049" (NEW)	----	16519.04
8 PINION SHIM KIT, 0.050-0.054" (NEW)	16519.05	16519.05
9 PINION OIL SEAL OUTER (NEW)	----	16521.21
9 PINION SEAL OUTER	----	16521.32
12 PINION NUT (NEW)	----	16584.10
13 DIFFERENTIAL COVER WITH HARDWARE (NEW)	----	16595.84
13A HEAVY DUTY DIFFERENTIAL COVER, 3/8" THICK CAST STEEL, WITH HARDWARE	16595.44	16595.44
13B HEAVY DUTY DIFFERENTIAL SKID PLATE, 3/16" THICK CAST STEEL, WITH HARDWARE	16597.44	16597.44
20 DIFFERENTIAL BEARING KIT	16525.30	16525.30
20 RING GEAR BOLT (NEW)	----	16521.80
20 DRIVE GEAR BOLT SET (NEW)	----	16521.81
20 DIFFERENTIAL REBUILD KIT* (NEW)	----	16501.10*
20 DIFFERENTIAL REBUILD KIT** (NEW)	----	16501.11**
22 RING GEAR BOLT SET (NEW)	16521.80*	16521.81**
23 CASE STANDARD DIFFERENTIAL, 2000-03	----	16503.64**
23 SPIDER GEAR SET, TRAC-LOK	16507.41	16507.41
30 REAR AXLE SHAFT RETAINER	----	16534.21
31 BEARING, REAR AXLE SHAFT	----	16536.31
32 OIL SEAL, REAR AXLE SHAFT	16534.20	16534.22
32 AXLE PLENUM, 1999-01 (NEW)	----	16508.41*
35 AXLE SHAFT, RH (without Hydra-Lok)	16530.12	16530.72
35 AXLE SHAFT, LH (without Hydra-Lok)	16530.11	16530.73
35 AXLE SHAFT, RH (with Hydra-Lok)	----	16530.14
35 AXLE SHAFT, LH (with Hydra-Lok)	----	16530.13
35 CASE ASSEMBLY KIT, STANDARD DIFFERENTIAL	16505.35	16505.35*
35 CASE ASSEMBLY KIT, 2000-03 W/ STD. DIFF.	----	16505.14**
35 CASE ASSEMBLY KIT, 2000-03 W/ HYDRA-LOK (NEW)	----	16505.37**
35 CASE ASSEMBLY KIT, TRAC-LOK, UP TO 3.73:1	16505.36	16505.36*
35 CASE ASSEMBLY KIT, 2000-01 W/ TRAC-LOK	----	16505.12**
38 TRAC-LOK DISK KIT (NEW)	16508.21	16508.20
43 CASE HYDRA-LOC DIFFERENTIAL	----	16505.39*

*with 3/8" ring gear bolts**with 7/16" ring gear bolts

UPGRADE
NEW!

16597.44
13B

Protect your factory differential cover with this heavy duty skid plate. Designed to fit the contours of your stock differential cover. Constructed of durable 3/16" black powder coated steel.

NOTE: 1999-3/29/2000 Grand Cherokees use 3/8" ring gear bolts, 3/29/2000-2004 Grand Cherokees use 7/16" ring gear bolts

DRIVE SHAFTS

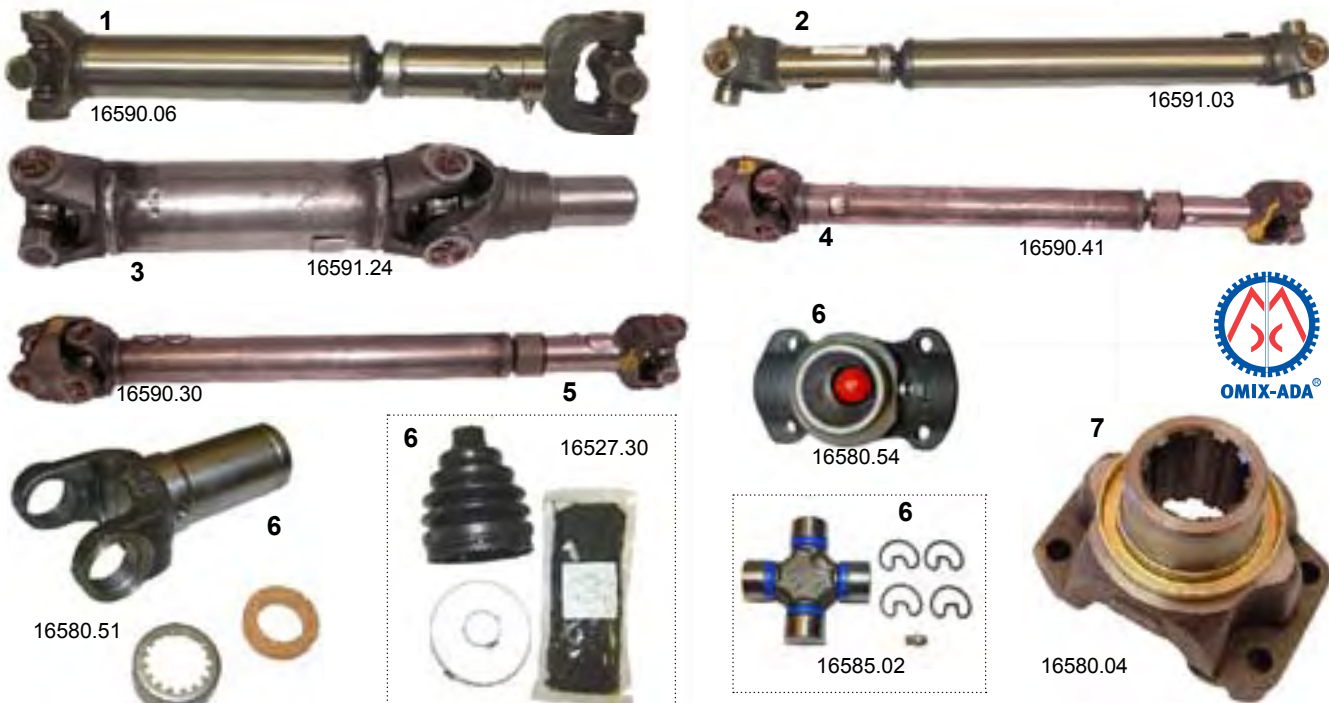

1 CJ FRONT DRIVE SHAFTS

YEAR	MODEL	ENGINE	TRANS	COLLAPSED LENGTH	PART #
1945-71	CJ2A, 3A, 3B, CJ5				16590.01
1976-79	CJ7	6 OR 8 CYL	AUTO	36-5/8"	16590.02
1976-79	CJ7, CJ5	6 OR 8 CYL	T150	26.50"	16590.03
1976-79	CJ7, CJ5	6 OR 8 CYL	T18	30.25"	16590.04
1981	CJ7, CJ8	4 CYL	AUTO	30.25"	16590.04
1980-81	CJ7, CJ8	4 OR 6 CYL	SR4	31.75"	16590.06
1982-86	CJ7, CJ5, CJ8	6 CYL	T4 OR T5	31.75"	16590.06
1980-81	CJ7, CJ5, CJ8	8 CYL	T170	29.50"	16590.07
1981-86	CJ7, CJ5, CJ8	6 CYL	T170	29.50"	16590.07
1982-86	CJ7, CJ5	4 CYL	T176	27.25"	16590.08
1983-86	CJ7, CJ5, CJ8	4 CYL	T4 OR T5	29.50"	16590.07

4 GRAND CHEROKEE DRIVE SHAFTS

DESCRIPTION	PART #
1992-93 6 CYL AUTOMATIC TRANS, FRONT	16590.40
1992-96 6 CYL AX15 MANUAL TRANS, FRONT	16590.41
1993 6 CYL 4WD AX15 MANUAL TRANS, REAR	16591.40
1993-95 V8 AUTOMATIC TRANS, FRONT	16590.43
1994 6-CYL WITH A500 AUTO TRANNY, FRONT	16590.42
1994-95 V8 A500 AUTOMATIC TRANS, FRONT	16590.44

5 CHEROKEE DRIVE SHAFTS

DESCRIPTION	PART #
1989-00 CHEROKEE 6 CYL 4.0L MAN. TRANS, FRONT	16590.30
1989-00 CHEROKEE 6 CYL 4.0L AUTO TRANS, FRONT	16590.31
1995-00 CHEROKEE, 2.5 DIESEL (EXPORT), FRONT	16590.32
1989-92 CHEROKEE, 6 CYL 4.0L MANUAL, EXPORT, FRONT	16590.33
1987-96 CHEROKEE, 6 CYL 4.0L 4WD, AUTOMATIC & DANA-35, REAR	16591.30

2 CJ REAR DRIVESHAFTS

YEAR	MODEL	ENGINE	TRANS	COLLAPSED LENGTH	PART #
1976-79	CJ7	6 OR 8 CYL	T150	26.50"	16591.01
1980	CJ7	4, 6 OR 8 CYL	AUTO	20.75"	16591.02
1981	CJ7	4, 6 OR 8 CYL	SR4	20.75"	16591.02
1982-86	CJ7	6 CYL	T4 OR T5	20.75"	16591.02
1980	CJ7	6 OR 8 CYL	T170	23-5/8"	16591.03
1980	CJ7	4 CYL	SR4	23-5/8"	16591.03
1981-86	CJ7	4 CYL	T4 OR T5	23"	16591.04
1981-86	CJ7	4, 6 OR 8 CYL	T170	23"	16591.04
1981-86	CJ7	6 OR 8 CYL	AUTO		16591.05
1976-79	CJ5	6 OR 8 CYL	T150	18.25"	16591.06
1980	CJ5	4 OR 6 CYL	SR4	13-7/8"	16591.07
1981	CJ5	4 OR 6 CYL	SR4	13"	16591.08
1982-86	CJ5	4 OR 6 CYL	T4 OR T5	13"	16591.08
1981	CJ8	4 OR 6 CYL	T170	33"	16591.09
1982-86	CJ8	4 CYL	T4 OR T5	33"	16591.09
1981-82	CJ8	4 OR 6 CYL	SR4	30.75"	16591.10
1982-86	CJ8	6 CYL	T4 OR T5	30.75"	16591.10
1948-71	CJ5, (CJ2A, 3A, 3B SERIAL# 13453 & UP)	4-CYL & 3-SPD			16591.11

3 WRANGLER DRIVE SHAFTS

DESCRIPTION	PART #
1987-95 6 CYL WRANGLER WITH MANUAL TRANS, FRONT	
1987-95 6 CYL WRANGLER WITH AUTO TRANS, FRONT	S-52088028
1993-95 6 CYL WRANGLER WITH AX15 TRANS, REAR	16591.21
1994-96 WRANGLER MANUAL, WITH 3" SLIP YOKE, REAR	S-52098221
1997-02 6 CYL WRANGLER WITH AX15 TRANS, FRONT	16590.22
1997-02 6 CYL WRANGLER WITH AUTO TRANS, FRONT	16590.23
2001-02 WRANGLER 2.5L AUTO TRANS, FRONT	16590.25
2001-06 WRANGLER 4.0L W/ MANUAL TRANS & DANA-35, REAR	16591.24
2003-04 WRANGLER WITH AUTO TRANS, FRONT 2.4L	16590.27
2003-06 4.0L WRANGLER WITH MANUAL TRANS, FRONT	16590.24
2003-06 2.4L WRANGLER WITH MANUAL TRANS, FRONT	16590.28
2003-06 WRANGLER WITH AUTOMATIC TRANSMISSION AND DANA-35 REAR AXLE, REAR	16591.25
2003-06 WRANGLER 4-CYL W/ MANUAL TRANSMISSION & DANA-35 REAR AXLE, REAR	16591.26
2007-10 WRANGLER 2- or 4-DOOR, FRONT, CV STYLE (NEW)	16592.22
2007-10 WRANGLER 2-DOOR, REAR, CV STYLE (NEW)	16592.21
2007-10 WRANGLER 4-DOOR, REAR, CV STYLE (NEW)	16592.20

6 MISC. AXLE COMPONENTS

DESCRIPTION	PART #
CV BOOT KIT (BOOT & CLAMP)	16527.30
1941-86 CJ FRONT & REAR DRIVESHAFT (except 1967-71 CJ front) U-JOINT	16585.01
1941-86 SAME AS ABOVE, SPICER BRAND U-JOINT	16585.02
1967-71 CJ FRONT DRIVESHAFT U-JOINT	16585.03
1967-92 WAGONEER, GRAND CHEROKEE, U-JOINT	16585.04
1987-93 WRANGLER FRONT OR REAR DRIVESHAFT 3-7/32" U-JOINT	16585.01
SAME AS ABOVE, SPICER BRAND	16585.02
1997-99 WRANGLER, FRONT OR REAR DRIVESHAFT 3-7/32" U-JOINT	16585.01
SAME AS ABOVE, SPICER BRAND	16585.02
1955-99 3-7/32" U-JOINT KIT, GREASE FEEDER ON BEARING, SPICER	16585.05
1994-95 WRANGLER REAR DRIVESHAFT 3-5/8" U-JOINT	16585.06
1997 WRANGLER REAR DRIVESHAFT 3-5/8" U-JOINT	16585.06
1945-95 U-BOLT KIT ALL MODELS (for U-bolt style yokes), PR. SAME AS ABOVE, SPICER BRAND	16582.01
1980-95 STRAP & BOLT KIT, PAIR	16582.03
1946-71 CJ SLIDING YOKE FOR FRONT DRIVE SHAFT	16580.51
1946-71 CJ SLIDING YOKE FOR REAR DRIVE SHAFT	16580.51
1974-86 CJ SLIDING YOKE FRT OR REAR DRIVE SHAFT	16580.52
1987-95 WRANGLER SLIDING YOKE	16580.53
1975-86 CJ & SJ, FRONT DRIVESHAFT CONSTANT VELOCITY YOKE	16580.54
1972-92 SJ WAGONEER OR CHEROKEE, THREADLOCKER, PERMANENT (RED), 5ML., (USA made)	19201.02

7 YOKE & YOKE DUST SHIELDS

DESCRIPTION	PART #
YOKE, 10 SPLINE	16580.04
YOKE, 10 SPLINE	16580.01
YOKE, DANA-18	18670.27
YOKE (SAME AS # 16580.02) EXCEPT WITH LARGER	16580.40

Axle & Differential

SLIP YOKE ELIMINATOR KITS & CV DRIVESHAFTS



UPGRADE

18676.60



SLIP YOKE ELIMINATOR KIT FOR NP231

This kit is a MUST if you installed a 2" or taller suspension lift (not needed for body lift). The kit fits all newer production NP 231 transfer cases (1987-up). This kit will eliminate the need to drop your transfer case in order to avoid drive train vibrations that are caused by taller suspension lift kits. The purpose of this kit is to replace the slip yoke portion of the NP 231 with a fixed-yoke, CV style drive shaft assembly. This is the most complete and strongest kit available. Check out the size and thickness of the output shaft housing.

MEGA SHORT SLIP YOKE ELIMINATOR KIT FOR NP231

NEW!



18676.72



For really tall lift systems and extreme off road capable vehicles, the **Rugged Ridge** Mega Short SYE kit for the NP231 transfer case is the choice for you. Designed to give you a 7" increase in rear drive shaft length (3 more inches than our regular SYE kit), this kit will support 6 inch and taller suspension lift systems. No dropped transfer case means better clearance. Longer drive shaft means no vibrations or binding, and increased travel for tall lifts.

Made of 356-T6 aluminum, and nodular reinforced for superior strength, the Mega Short SYE housing is the strongest available anywhere. In addition, the tone ring has 8 holes machined in it to allow maximum oiling to the main bearing. To top that off, a large 209 Series roller bearing supports the main output shaft for long life and reliability. You can count on this kit.

In conjunction with a CV Driveshaft, the Mega Short Slip Yoke Eliminator Kit will strengthen your drive train by eliminating the weak link – a stock slip yoke. The kit comes complete with all hardware, instructions and sensor to make this a bolt on kit.

NOTE: Will not work with cable driven speedometers.



16592.05

! WARNING

OEM slip yokes on 1987-2006 Jeep® Wrangler are not suitable for use with 2" or taller Rugged Ridge™ or other vendors' suspension lifts. Failure of slip yoke may result in damage to transfer case and/or loss of vehicle control. Use of this slip yoke eliminator kit is required for all suspension lifts 2' or taller. See additional product safety information and WARNINGS at front of catalog.

CV REAR DRIVESHAFT FOR 1987-10 WRANGLER

*THESE DRIVESHAFTS ARE A MUST WHEN USING SLIP YOKE ELIMINATOR KITS ON NEW PROCESS 231

DESCRIPTION	PART #
1987-93 WRANGLER WITH UP TO 3" LIFT	16592.01
1987-93 WRANGLER WITH OVER TO 3" LIFT	16592.02
1994-95 WRANGLER WITH UP TO 3" LIFT	16592.03*
1994-95 WRANGLER WITH OVER TO 3" LIFT	16592.04*
1997-06 WRANGLER WITH 2" TO 6" LIFT	16592.05
1997-06 WRANGLER WITH 3.5" TO 6" LIFT (perfect for use with Mega SYE # 18676.72)	16592.06
2007-10 WRANGLER 2- or 4-DOOR, FRONT, CV STYLE (NEW)	16592.22
2007-10 WRANGLER 2-DOOR, REAR, CV STYLE (NEW)	16592.21
2007-10 WRANGLER 4-DOOR, REAR, CV STYLE (NEW)	16592.20

* THESE DRIVESHAFTS USE 3-5/8" WIDE U-JOINT, PLEASE VERIFY THE U-JOINT SIZE

SLIP YOKE ELIMINATORS:

DESCRIPTION	PART #
1987-06 WRANGLER EXCEPT RUBICON, SLIP YOKE ELIMINATOR KIT FOR NP231	18676.60
NOTE: A CV equipped drive shaft will be required for this conversion kit.	
PINION YOKE FOR SLIP YOKE ELIMINATOR KIT	18676.61
SEAL FOR SLIP YOKE ELIMINATOR KIT	18676.62
HARDWARE KIT FOR SLIP YOKE ELIMINATOR KIT	18676.64
1987-06 WRANGLER EXCEPT RUBICON, MEGA SHORT SLIP YOKE ELIMINATOR KIT FOR NP231	18676.72

NOTE: A CV equipped drive shaft will be required for this conversion kit.

MASTER CYLINDER

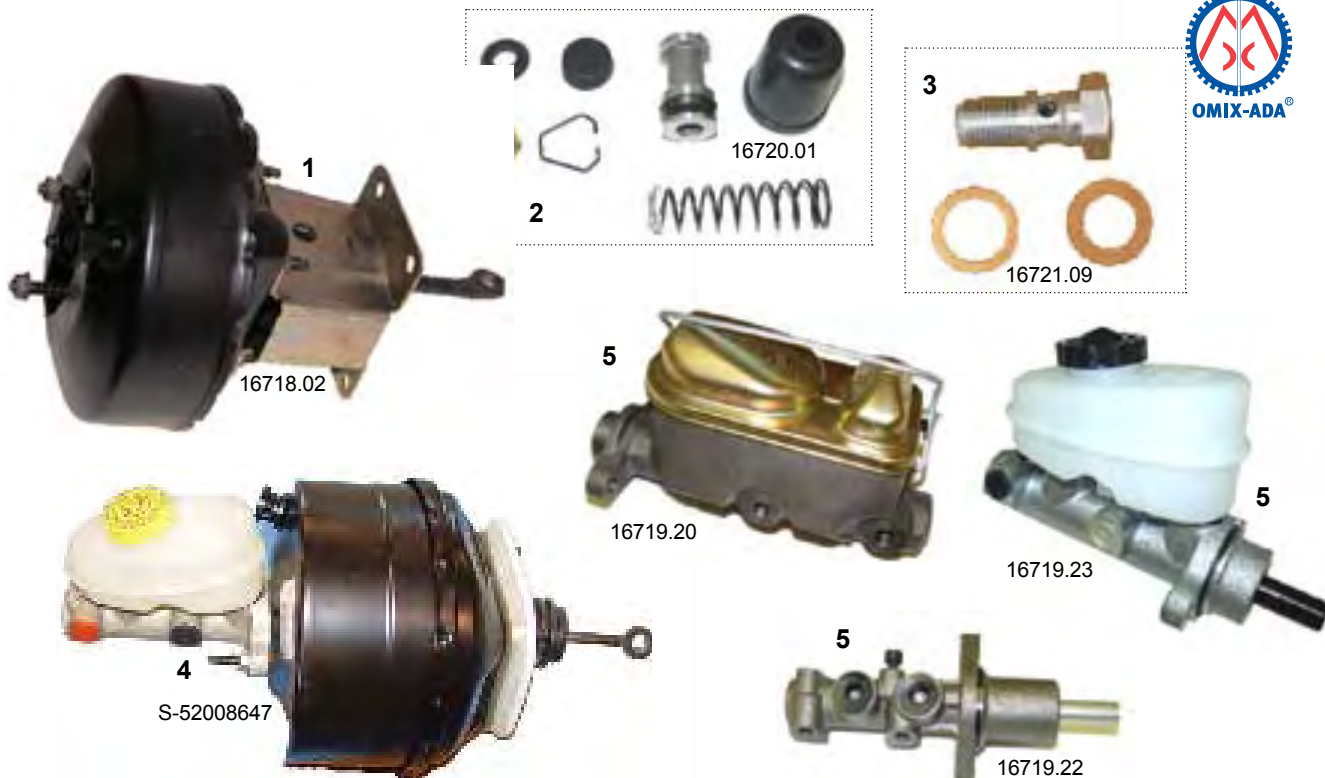

1 BRAKE POWER BOOSTERS

DESCRIPTION	PART #
1976-86 CJ Power Booster Bracket (NEW)	16721.10
1982-86 CJ	16718.01
1987-90 WRANGLER	16718.02
1984-90 CHEROKEE (with gas or diesel engine)	16718.04
1991-94 CHEROKEE EXPORT MODEL (with gas engine)	16718.04
1995-96 CHEROKEE (with gas engine)	16718.05
1997-01 CHEROKEE	16718.07
1995-98 GRAND CHEROKEE	16718.06

2 BRAKE MASTER CYLINDER REPAIR KITS

DESCRIPTION	PART #
1941-45 MB	16720.01
1945-66 CJ	16720.01
1967-71 CJ	16720.02
1974-80 SJ	16720.03
1984-89 CHEROKEE	16720.04
1987-89 WRANGLER	16720.04

3 BRAKE MASTER CYLINDER MISC. ITEMS

DESCRIPTION	PART #
1941-45 MB, MASTER CYL BOLT & WASHER KIT(3 pcs)	16721.09
1941-45 MB, MASTER CYLINDER FITTING BOLT	16721.08
1941-45 MB, WASHER BETWEEN MASTER CYLINDER & OUTLET FITTING	16721.06
1941-66 MB, WASHER BETWEEN OUTLET FITTING & FITTING BOLT	16721.07
1945-49 CJ2A, WASHER BETWEEN MASTER CYLINDER & OUTLET FITTING	16721.06
1945-49 CJ2A, WASHER BETWEEN OUTLET FITTING & FITTING BOLT	16721.07
1948-53 CJ3A, MASTER CYLINDER FITTING BOLT	16721.08
1948-53 CJ3A, MASTER CYL BOLT & WASHER KIT (3 pcs)	16721.09
1948-53 CJ3A, WASHER BETWEEN MASTER CYLINDER & OUTLET FITTING	16721.06
1948-53 CJ3A, WASHER BETWEEN OUTLET FITTING & FITTING BOLT	16721.07
1950-52 M38, MASTER CYL BOLT & WASHER KIT(3 pcs)	16721.09
1950-52 M38, MASTER CYLINDER FITTING BOLT	16721.08
1950-52 M38, WASHER BETWEEN MASTER CYLINDER & OUTLET FITTING	16721.06
1950-52 M38, WASHER BETWEEN OUTLET FITTING & FITTING BOLT	16721.07
1953-65 CJ3B, MASTER CYLINDER FITTING BOLT	16721.08
1953-65 CJ3B, MASTER CYL BOLT & WASHER KIT (3 pcs)	16721.09
1953-65 CJ3B, WASHER BETWEEN MASTER CYLINDER & OUTLET FITTING	16721.06
1953-65 CJ3B, WASHER BETWEEN OUTLET FITTING & FITTING BOLT	16721.07
1955-66 CJ5, MASTER CYL BOLT & WASHER KIT(3 pcs)	16721.09
1955-66 CJ5, MASTER CYLINDER FITTING BOLT	16721.08
1955-66 CJ5, WASHER BETWEEN MASTER CYLINDER & OUTLET FITTING	16721.06
1955-66 CJ5, WASHER BETWEEN OUTLET FITTING & FITTING BOLT	16721.07

4 POWER BOOSTER, BRACKET & MASTER CYLINDER KITS

DESCRIPTION	PART #
1995-96 CHEROKEE KIT (NEW)	S-52008647
1978-86 CJ BRAKE MASTER CYLINDER KIT W/ 2-BOLT CALAPER (NEW)	16718.20
1976-78 CJ w/ 6 bolt Caliper Plate Kit (NEW)	16718.21

5 BRAKE MASTER CYLINDERS (NEW, NOT REBUILT)

DESCRIPTION	PART #
1941-45 MB	16719.01
1945-48 CJ2A	16719.01
1949-66 CJ	16719.03
1972-76 CJ WITHOUT POWER BRAKE, WITH FRONT DRUM BRAKE	16719.06
1976-78 CJ WITH POWER BRAKES, WITH FRONT DISC BRAKE	16719.09
1976-78 CJ WITHOUT POWER BRAKE, WITH FRONT DISC BRAKE W/6-BOLT CALIPER PLATE	16719.08
1977-78 CJ WITHOUT POWER BRAKE, WITH FRONT DRUM BRAKE	16719.07
1978-86 CJ WITH POWER, DISC BRAKE, WITH 2-BOLT CALIPER PLATE	16719.11
1978-86 CJ WITHOUT POWER, DISC BRAKE, WITH 2-BOLT CALIPER PLATE	16719.10
1948-63 WILLYS WAGON	16719.03
1950-52 M38	16719.03
1952-63 M38A1	16719.03
1982-UP POSTAL JEEP, 4 CYL	16719.12
1987-89 WRANGLER	16719.13
1990-94 WRANGLER W/O ABS	16719.14
1994 WRANGLER W/REAR DISC BRAKE	16719.15
1995 WRANGLER W/ OR W/O ABS	16719.16
1997-06 WRANGLER (all models)	16719.17
1990-94 CHEROKEE EXPORT MODELS ONLY (gas or diesel)	16719.21
1984-89 CHEROKEE	16719.13
1990-94 CHEROKEE WITHOUT ABS	16719.20
1992-93 CHEROKEE, WITH ABS	16719.22
1994 CHEROKEE WITH ABS	16719.15
1995-01 CHEROKEE	16719.23
1993 GRAND CHEROKEE, WITH ABS	16719.22
1993-94 GRAND CHEROKEE WITH ABS	16719.15
1995-98 GRAND CHEROKEE	16719.23
1974-80 SJ WITH POWER BRAKES	16719.18
1981-91 SJ	16719.19

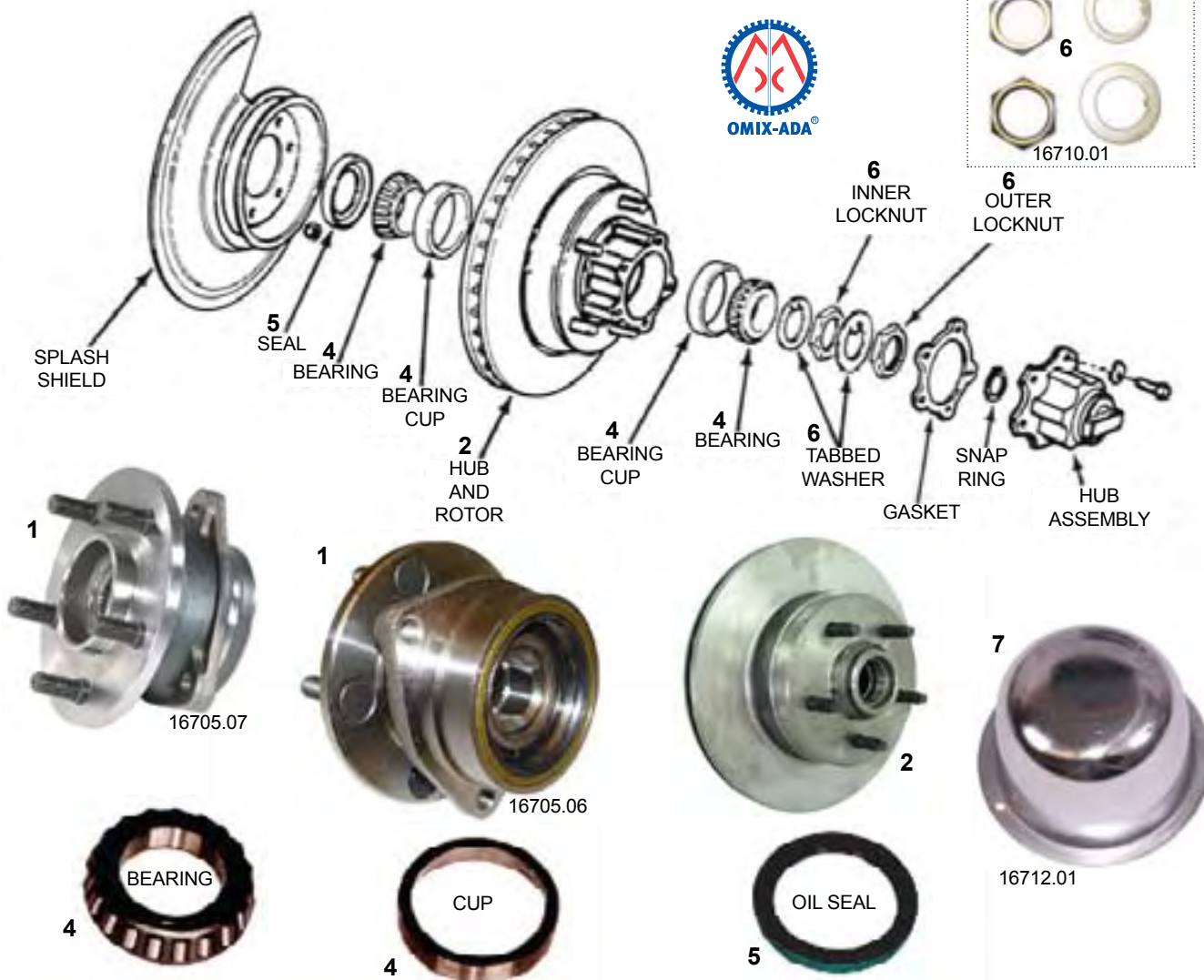

1 FRONT HUBS

DESCRIPTION	PART #
1941-63 ALL, HUB WITH LH THREAD STUDS	16705.01
1941-63 ALL, HUB WITH RH THREAD STUDS	16705.02
1941-63 ALL MODELS, HUB (w/o studs)	16705.03
1965-81 CJ W/6 BOLT LOCKOUT HUBS (w/o cups or studs)	16705.04
1981-86 CJ W/5 BOLT LOCKOUT HUBS (w/o cups or studs)	16705.05
1987-89 WRANGLER, ASSY. (w/ bearings, seals & studs)	16705.06
1990-95 WRANGLER, ASSEMBLY (w/ bearings, seals & studs)	16705.07
1997-99 WRANGLER, ASSEMBLY (w/ bearings, seals & studs)	16705.07
2000-06 WRANGLER, HUB ASSEMBLY	16705.08
1984-89 CHEROKEE, ASSY. (w/ bearings, seals & studs)	16705.06
1990-99 CHEROKEE, ASSEMBLY (w/ bearings, seals & studs)	16705.07
2000-01 CHEROKEE, HUB ASSEMBLY	16705.08
1993-98 GRAND CHEROKEE, ASSEMBLY (w/ bearings, seals & studs)	16705.07
1999-04 GRAND CHEROKEE, HUB ASSEMBLY	16705.09
2002-06 LIBERTY, HUB ASSEMBLY WITH ABS, RH	16705.12
2002-06 LIBERTY, HUB ASSEMBLY WITH ABS, LH	16705.11
2002-06 LIBERTY, HUB ASSEMBLY WITHOUT ABS	16705.10

2 HUBS & ROTORS (FRONT)

DESCRIPTION	PART #
1976-78 CJ W/ 1-1/8" THICK ROTOR (not assembled)	16704.01
1978-81 CJ 7/8" THICK ROTOR, 6 BOLT HUB (not assembled)	16704.02
(factory assembly)	16704.03
1981-86 CJ 7/8" THICK ROTOR, 5 BOLT HUB (not assembled)	16704.04
(factory assembly)	16704.05

3 BRAKE SPLASH SHIELD (pair):

DESCRIPTION	PART #
1976-78 CJ W/ 6 BOLT CALIPER PLATES, (black powder)	11212.01
1976-78 CJ W/ 6 BOLT CALIPER PLATES, (stainless steel)	11212.01
1978-86 CJ W/ 2 BOLT CALIPER PLATES, (black powder)	11212.02
1978-86 CJ W/ 2 BOLT CALIPER PLATES, (stainless steel)	11212.02

4 FRONT HUB BEARINGS & CUPS

DESCRIPTION	PART #
1945-64 CJ INNER BEARING	16706.01
1945-64 CJ INNER CUP	16707.01
1945-64 CJ OUTER BEARING	16706.01
1945-64 CJ OUTER CUP	16707.01
1965-76 CJ INNER BEARING	16706.02
1965-76 CJ INNER CUP	16707.02
1965-76 CJ OUTER BEARING	16706.02
1965-76 CJ OUTER CUP	16707.02
1977-86 CJ INNER BEARING	16706.03
1977-86 CJ INNER CUP	16707.03
1977-86 CJ OUTER BEARING	16706.02
1977-86 CJ OUTER CUP	16707.02
1987-89 WRANGLER, BEARING & CUP (inner or outer)	16709.01
1984-89 CHEROKEE, BEARING & CUP (inner or outer)	16709.01

5 FRONT HUB BEARING OIL SEALS

DESCRIPTION	PART #
1945-64 CJ	16708.01
1965-76 CJ	16708.02
1977-86 CJ	16708.03
1987-90 WRANGLER, INNER	16708.04
1984-89 CHEROKEE, INNER	16708.04
1974-91 SJ	16708.05

6 SPINDLE NUT & TABBED WASHER

DESCRIPTION	PART #
1945-86 CJ SPINDLE NUT & WASHER KIT (2 nuts & 2 washers)	16710.01
1945-86 CJ SPINDLE NUT SOCKET	16711.01
1969-96 Dana 44 (2 nuts & 2 washers) (NEW)	15002.18

7 HUB CAPS

DESCRIPTION	PART #
1941-45 MB, HUB CAP	16712.01
1945-64 CJ, HUB CAP	16712.01

DRUM BRAKES



1 REAR AXLE HUBS

DESCRIPTION	PART #
1941-45 MB, REAR HUB WITH LH THREAD STUDS	16705.01
1941-45 MB, REAR HUB WITH RH THREAD STUDS	16705.02
1941-45 MB, REAR HUB (without studs)	16705.03

2 LUG NUTS

DESCRIPTION	PART #
1941-46 MB, EARLY CJ2A, LH THREAD	16715.01
1941-46 MB, EARLY CJ2A, RH THREAD	16715.02
1945-71 CJ, LH THREAD, FRONT OR REAR (each)	16715.03
1945-86 CJ, RH THREAD, FRONT OR REAR (each)	16715.04
1945-86 CJ, RH THREAD, CHROME, FRONT OR REAR (each)	16715.05
1987-98 WRANGLER, RH THREAD, CHROME, FRONT OR REAR (each)	16715.06

3 WHEEL STUDS

DESCRIPTION	PART #
1941-45 MB, FRONT OR REAR, LH THREAD	16714.01
1941-45 MB, FRONT OR REAR, RH THREAD	16714.02
1945-49 CJ2A, CJ3A, FRONT OR REAR, LH THREAD	16714.01
1945-49 CJ2A, CJ3A, FRONT OR REAR, RH THREAD	16714.02
1948-53 CJ3A, FRONT OR REAR, LH THREAD	16714.01
1948-53 CJ3A, FRONT OR REAR, RH THREAD	16714.02
1964-78 CJ, RH THREAD, DRUM BRAKE, FRONT (each)	16714.03
1970-86 CJ W/ DANA 44 OR AMC-20 AXLE, REAR (each)	16714.06
1977-86 CJ, RH THREAD, DISC BRAKE, FRONT (each)	16714.04
2001-02 WRANGLER, REAR	16714.10
2003-06 WRANGLER, FRONT	16714.11

4 DRUM BRAKE SHOE ANCHOR CAMS (each)

DESCRIPTION	PART #
1941-45 MB	16750.01
1945-49 CJ2A	16750.01
1948-53 CJ3A	16750.01
1950-52 M38	16750.01

5 DRUM BRAKE SHOE ANCHOR PIN KITS

DESCRIPTION	PART #
1941-45 MB	16750.02
1945-49 CJ-2A	16750.02
1948-53 CJ-3A	16750.02
1950-52 M38	16750.02

6 DRUM BRAKE SHOE ANCHOR END SPRINGS (short)

DESCRIPTION	PART #
1955-65 CJ3B	16750.14
1955-65 CJ5	16750.14
1955-65 CJ6	16750.14
1952-65 M38A1	16750.14

7 BRAKE DRUMS (front or rear)

DESCRIPTION	PART #
1941-45 MB, 9" BRAKE	16701.01
1946-47 CJ2A, 9" BRAKE	16701.01
1946-54 4 CYL 2WD WAGON (also fits 1948-51 2WD Jeepster)	16701.11
1948-63 226 WAGON OR TRUCK, 11", FRONT OR REAR	16701.10
1948-65 CJ W/ 9" BRAKE, FRONT OR REAR	16701.02
1965-71 CJ W/ 10" BRAKE, FRONT OR REAR	16701.03
1972-74 CJ W/ 11" BRAKE, UNFINNED, FRONT OR REAR	16701.04
1974-78 CJ W/ 11" BRAKE, FINNED, FRONT OR REAR	16701.05
1978-86 CJ W/ 10" BRAKE, REAR	16701.06
1974-78 SJ WAGONEER, CHEROKEE, UNFINNED, FRONT OR REAR	16701.12
1978-91 SJ WAGONEER, CHEROKEE, FINNED, REAR	16701.13
1987-89 WRANGLER W/ 10" BRAKE, REAR	16701.07
1987-93 WRANGLER W/ 10 X 2.5" BRAKE, W/ DANA-44 AXLE, REAR	16701.09
1990-06 WRANGLER W/ 9 X 2.5", DANA 35 AXLE, REAR	16701.08
1984-89 CHEROKEE W/ 10" BRAKE & DANA-35 REAR AXLE	16701.07
1986-89 CHEROKEE W/ 10 X 2.5" BRAKE, W/ DANA-44 AXLE, REAR	16701.09
1990-01 CHEROKEE W/ 10" BRAKE, REAR	16701.16
1990-01 CHEROKEE W/ 9" BRAKE, REAR	16701.08
1993-98 GRAND CHEROKEE W/ 10" BRAKE, REAR	16701.16
1993-98 GRAND CHEROKEE W/ 9" BRAKE, REAR	16701.08
2002 LIBERTY, REAR BRAKE DRUM	16701.17
POSTAL DJ'S FRONT	16701.14
POSTAL DJ'S REAR	16701.15

8 BRAKE SHOE SETS, FRONT OR REAR (per axle)

DESCRIPTION	PART #
1941-45 MB 9" BRAKE, FRONT OR REAR	16726.01
1941-45 MB 9" BRAKE, LINING SET w/ RIVETS (w/o steel)	16727.01
1945-49 CJ2A 9" BRAKE, FRONT OR REAR	16726.01
1948-53 CJ3A 9" BRAKE, FRONT OR REAR	16726.01
1953-64 CJ3B 9" BRAKE, FRONT OR REAR	16726.01
1945-49 CJ2A 9" BRAKE, LINING SET w/ RIVETS (w/o steel)	16727.01
1948-53 CJ3A 9" BRAKE, LINING SET w/ RIVETS (w/o steel)	16727.01
1953-65 CJ3B 9" BRAKE, LINING SET w/ RIVETS (w/o steel)	16727.01
1955-66 CJ5 9" BRAKE, LINING SET w/ RIVETS (w/o steel)	16727.01
1953-66 CJ 9" BRAKE, FRONT OR REAR	16726.02
1966-71 CJ 10" BRAKE, FRONT OR REAR	16726.03
1972-78 CJ 11" BRAKE, FRONT OR REAR	16726.04
1978-86 CJ 10" BRAKE, REAR, BENDIX	16726.16
1978-86 CJ 10" BRAKE, REAR	16726.05
1948-63 11" STATION OR TRUCK 226	16726.11
1974-90 SJ J-20 TRUCK	16726.13
1977-91 SJ WAGONEER, REAR	16726.12
1987-89 WRANGLER 10" BRAKE W/ DANA-35 REAR AXLE, REAR	16726.05
1987-89 WRANGLER, 10" BRAKE, REAR, BENDIX	16726.16
1987-92 WRANGLER W/ 10" BRAKE & DANA-44 REAR AXLE, REAR	16726.08
1990-95 WRANGLER, 9" BRAKE, REAR, BENDIX	16726.17
1990-06 WRANGLER W/ DANA-35 AXLE & 9" BRAKE, REAR	16726.06
2001-06 WRANGLER W/ 9" BRAKE, REAR	16726.07
1984-89 CHEROKEE W/ DANA-35 REAR AXLE, REAR	16726.05
1984-89 CHEROKEE W/ DANA-44 REAR AXLE, REAR	16726.08
1984-89 CHEROKEE, 10" BRAKE, REAR, BENDIX	16726.16
1990-00 CHEROKEE, 9" BRAKE, REAR	16726.06
1990-00 CHEROKEE, 9" BRAKE, REAR, BENDIX	16726.17
1994-01 CHEROKEE, 10" BRAKE, REAR	16726.14
1994-01 CHEROKEE, 10" BRAKE, REAR, BENDIX (NEW)	16726.18
2001 CHEROKEE W/ 9" BRAKE, REAR	16726.07
1993-98 GRAND CHEROKEE, 9" BRAKE, REAR	16726.06
1993-98 GRAND CHEROKEE, 9" BRAKE, REAR, BENDIX	16726.17
1994-98 GRAND CHEROKEE, 10" BRAKE, REAR	16726.14
1994-98 GRAND CHEROKEE, 10" BRAKE, REAR, BENDIX (NEW)	16726.18
2002 LIBERTY W / REAR DRUM BRAKE	16726.15
POSTAL APPLICATIONS, FRONT	16726.09
POSTAL APPLICATIONS, REAR	16726.10



1 16722.09



2 16723.10

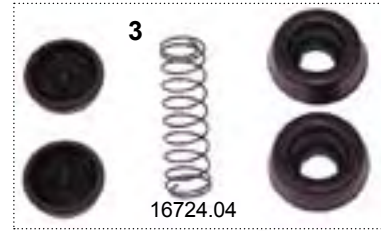

3 16724.04



4 16752.04

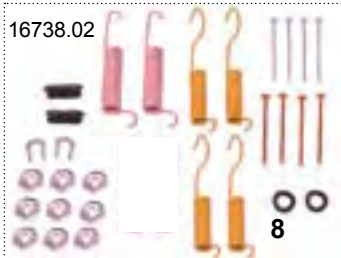

16738.02

8



16752.03



16752.01



16752.02

1 FRONT BRAKE WHEEL CYLINDERS

DESCRIPTION	PART #
1941-45 MB LEFT OR RIGHT	16722.01
1941-45 MB LEFT OR RIGHT (brand name)	16722.02
1945-49 CJ2A LEFT OR RIGHT	16722.01
1945-49 CJ2A LEFT OR RIGHT (brand name)	16722.02
1948-53 CJ3A LEFT OR RIGHT	16722.01
1948-53 CJ3A LEFT OR RIGHT (brand name)	16722.02
1950-52 M38 LEFT OR RIGHT	16722.01
1950-52 M38 LEFT OR RIGHT (brand name)	16722.02
1953 CJ3B LEFT OR RIGHT	16722.01
1953 CJ3B LEFT OR RIGHT (brand name)	16722.02
1954-65 CJ W/O ANGLE HOSE CONNECTION	16722.03
1963-66 CJ W/ 60° ANGLE HOSE CONNECTION, LEFT	16722.05
1963-66 CJ W/ 60° ANGLE HOSE CONNECTION, RIGHT	16722.06
1967-71 CJ 10" BRAKE, 1-1/8" CYLINDER, LEFT OR RIGHT	16722.08
1967-71 CJ BRAKE, 1" CYLINDER, LEFT OR RIGHT	16722.07
1972-77 CJ 11" BRAKE, LEFT	16722.09
1972-77 CJ 11" BRAKE, RIGHT	16722.10
1948-63 WAGON OR TRUCK 4-475, LEFT	16722.11
1948-63 WAGON OR TRUCK 4-475, RIGHT	16722.12
1979-88 J20, LEFT OR RIGHT	16723.22
1982-83 POSTAL DJ REAR, LEFT	16723.21
1982-83 POSTAL DJ FRONT, RIGHT	16723.20

2 REAR BRAKE WHEEL CYLINDERS

DESCRIPTION	PART #
1941-45 MB, LEFT OR RIGHT	16723.01
1945-49 CJ, LEFT OR RIGHT	16723.01
1950-66 CJ W/ 9" BRAKE, LEFT OR RIGHT	16723.03
1950-66 CJ W/ 9" BRAKE, LEFT OR RIGHT (brand name)	16723.04
1967-71 CJ W/ 10" BRAKE, LEFT	16723.05
1967-71 CJ W/ 10" BRAKE, RIGHT	16723.06
1972-75 CJ W/ 11" BRAKE, 15/16" CYL, LEFT	16723.07
1972-75 CJ W/ 11" BRAKE, 15/16" CYL, RIGHT	16723.08
1976-86 CJ W/ 10" OR 11" BRAKE, LEFT	16723.09
1976-86 CJ W/ 10" OR 11" BRAKE, RIGHT	16723.10
1948-63 WAGON OR TRUCK 4-475, LEFT	16723.13
1948-63 WAGON OR TRUCK 4-475, RIGHT	16723.14
1974-91 SJ, LEFT OR RIGHT	16723.12
1979-88 SJ J20, LEFT OR RIGHT	16723.22
1987-89 WRANGLER W/ 10" OR 11" BRAKE, LEFT	16723.09
1987-89 WRANGLER W/ 10" OR 11" BRAKE, RIGHT	16723.10
1990-00 WRANGLER, LEFT OR RIGHT	16723.11
1997-06 WRANGLER WITH ABS & WITH 10" BRAKE, RH=LH	16723.18
1984-89 CHEROKEE, LEFT	16723.09
1984-89 CHEROKEE, RIGHT	16723.10
1990-01 CHEROKEE WITH ABS & WITH 10" BRAKE, RH=LH	16723.18
1991-01 CHEROKEE W/ 9" BRAKE W/O ABS, RH=LH	16723.11
1994-01 CHEROKEE W/ 10", W/O ABS, LEFT	16723.09
1994-01 CHEROKEE W/ 10", W/O ABS, RIGHT	16723.10
1993-98 GRAND CHEROKEE W/ 9" BRAKE W/O ABS, RH=LH	16723.11
1993-98 GRAND CHEROKEE, WITH ABS & WITH 10" BRAKE, RH=LH	16723.18
2002 LIBERTY	16723.19

3 WHEEL CYLINDER REPAIR KITS

DESCRIPTION	PART #
ALL 3/4" CYLINDERS	16724.01
ALL 13/16" CYLINDERS	16724.02
ALL 7/8" CYLINDERS	16724.03
ALL 1" CYLINDERS	16724.04
ALL 1-1/8" CYLINDERS	16724.05
ALL 15/16" CYLINDERS	16724.06

4 DRUM BRAKE SHOE RETURN SPRINGS

DESCRIPTION	PART #
1982-86 CJ	16752.04
1987-89 WRANGLER	16752.04
1990-99 WRANGLER 9"	16752.14
1984-89 CHEROKEE	16752.04
1990-99 CHEROKEE 9"	16752.14
1993-01 CHEROKEE 10"	16752.04
1993-99 GRAND CHEROKEE 9"	16752.14
1993-98 GRAND CHEROKEE 10"	16752.04

5 DRUM BRAKE SHOE EQUALIZER SPRINGS

DESCRIPTION	PART #
1982-86 CJ	16752.03
1987-89 WRANGLER	16752.03
1990-99 WRANGLER 9"	16752.20
1984-89 CHEROKEE	16752.03
1990-01 CHEROKEE 9"	16752.20
1993-99 GRAND CHEROKEE 9"	16752.20

6 DRUM BRAKE SHOE HOLD DOWN CUPS

DESCRIPTION	PART #
1982-86 CJ	16752.01
1987-89 WRANGLER	16752.01
1984-89 CHEROKEE	16752.01

7 DRUM BRAKE SHOE HOLD DOWN SPRINGS

DESCRIPTION	PART #
1982-86 CJ	16752.02
1987-89 WRANGLER	16752.02
1990-99 WRANGLER 9"	16752.12
1984-89 CHEROKEE	16752.02
1990-01 CHEROKEE 9"	16752.12
1993-99 GRAND CHEROKEE 9"	16752.12

8 DRUM BRAKE HOLD DOWN HARDWARE KITS

DESCRIPTION	PART #
1953-66 CJ W/ 9", (per wheel)	16750.03
1972-78 CJ W/ 11" BRAKE, FRONT OR REAR (per axle)	16738.01
1978-86 CJ W/ 10" BRAKE, REAR (per axle)	16738.02
1987-89 WRANGLER W/ 10" BRAKE, REAR (per axle)	16738.02
1990-00 WRANGLER W/ 10" BRAKE, REAR (per axle)	16738.03
1990-01 CHEROKEE W/ 10" BRAKE, REAR (per axle)	16738.03
1993-98 GRAND CHEROKEE W/ 10" BRAKE, REAR (per axle)	16738.03

DRUM BRAKES



1

16752.06

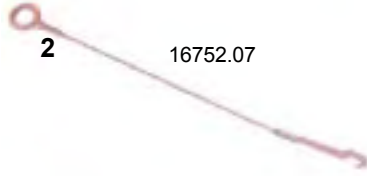

2

16752.07



3

16752.08



4

16752.10



6

16752.11



7

16751.01



5

16739.05

1 DRUM BRAKE SELF ADJUSTING LEVERS

DESCRIPTION	PART #
1982-86 CJ, LH	16752.05
1982-86 CJ, RH	16752.06
1987-89 WRANGLER, LH	16752.05
1987-89 WRANGLER, RH	16752.06
1990-99 WRANGLER 9", LH=RH	16752.18
1984-89 CHEROKEE, LH	16752.05
1984-89 CHEROKEE, RH	16752.06
1990-99 CHEROKEE 9", LH=RH	16752.18
1993-01 CHEROKEE 10" BRAKE, RH	16752.22
1993-01 CHEROKEE 10" BRAKE, LH	16752.23
1990-99 GRAND CHEROKEE 9", LH=RH	16752.18
1993-98 GRAND CHEROKEE 10" BRAKE, RH	16752.22
1993-98 GRAND CHEROKEE 10" BRAKE, LH	16752.23

2 DRUM BRAKE SELF ADJUSTING CABLES

DESCRIPTION	PART #
1982-86 CJ	16752.07
1987-89 WRANGLER	16752.07
1990-99 WRANGLER 9", RH=LH	16752.17
1984-89 CHEROKEE	16752.07
1990-01 CHEROKEE 9", RH=LH	16752.17
1993-01 CHEROKEE 10" BRAKE	16752.21
1990-99 GRAND CHEROKEE 9", RH=LH	16752.17
1993-98 GRAND CHEROKEE 10" BRAKE	16752.21

3 DRUM BRAKE SELF ADJUSTING CABLE GUIDES

DESCRIPTION	PART #
1982-86 CJ	16752.08
1987-89 WRANGLER	16752.08
1990-99 WRANGLER 9"	16752.13
1984-89 CHEROKEE	16752.08
1990-01 CHEROKEE 9"	16752.13
1993-98 GRAND CHEROKEE 9"	16752.13

4 DRUM BRAKE SELF ADJUSTING SCREWS

DESCRIPTION	PART #
1982-86 CJ, LH	16752.09
1982-86 CJ, RH	16752.10
1987-89 WRANGLER, LH	16752.09
1987-89 WRANGLER, RH	16752.10
1990-99 WRANGLER 9", RH	16752.15
1990-99 WRANGLER 9", LH	16752.16
1984-89 CHEROKEE, LH	16752.09
1984-89 CHEROKEE, RH	16752.10
1990-01 CHEROKEE 9", RH	16752.15
1990-01 CHEROKEE 9", LH	16752.16
1993-98 GRAND CHEROKEE 9", RH	16752.15
1993-98 GRAND CHEROKEE 9", LH	16752.16

5 DRUM BRAKE SELF-ADJUSTING HARDWARE KITS

DESCRIPTION	PART #
1972-78 CJ WITH 11" BRAKE, FRONT OR REAR, LEFT	16739.01
1972-78 CJ WITH 11" BRAKE, FRONT OR REAR, RIGHT	16739.02
1978-86 CJ WITH 10" BRAKE, REAR, LEFT	16739.03
1978-86 CJ WITH 10" BRAKE, REAR, RIGHT	16739.04
1987-89 WRANGLER W/ 10" BRAKE & DANA-35, REAR LEFT	16739.03
1987-89 WRANGLER W/ 10" BRAKE & DANA-35, REAR RIGHT	16739.04
1984-89 CHEROKEE W/ 10" BRAKE & DANA-35, REAR LEFT	16739.03
1984-89 CHEROKEE W/ 10" BRAKE & DANA-35, REAR RIGHT	16739.04
1990-05 WRANGLER W/ 9" BRAKE & DANA-35, REAR LEFT	16739.05
1990-05 WRANGLER W/ 9" BRAKE & DANA-35, REAR RIGHT	16739.06
1990-01 CHEROKEE W/ 9" BRAKE & DANA-35, REAR LEFT	16739.05
1990-01 CHEROKEE W/ 9" BRAKE & DANA-35, REAR RIGHT	16739.06
1993-98 GRAND CHEROKEE W/ 9" BRAKE & DANA-35, REARLEFT	16739.05
1993-98 GRAND CHEROKEE W/ 9" BRAKE & DANA-35, REARRIGHT	16739.06

6 MISC DRUM BRAKE SPRINGS

DESCRIPTION	PART #
1941-66 MB, M38, M38A, CJ, UPPER SPRING FOR BRAKE SHOE RETURN	16750.13
1982-86 CJ, SPRING BRAKE	16752.11
1987-89 WRANGLER, SPRING BRAKE	16752.11
1990-99 WRANGLER 9" BRAKE SPRING	16752.19
1984-89 CHEROKEE, SPRING BRAKE	16752.11
1990-01 CHEROKEE 9", BRAKE SPRING	16752.19
1993-98 GRAND CHEROKEE 9" BRAKE SPRING	16752.19

7 MISC DRUM BRAKE HARDWARE

DESCRIPTION	PART #
1941-71 FRONT AXLE SHAFT DRIVE FLANGE	16750.08
1978-86 CJ W/ 10" BRAKE, SHOE RETAINING PLATE	16751.01
1987-00 WRANGLER W/ 10" BRAKE, SHOE RETAINING PLATE	16751.01
1978-89 CJ W/ 10" BRAKE, WHEEL CYLINDER LINK	16751.02
1987-89 WRANGLER W/ 10" BRAKE, WHEEL CYLINDER LINK	16751.02

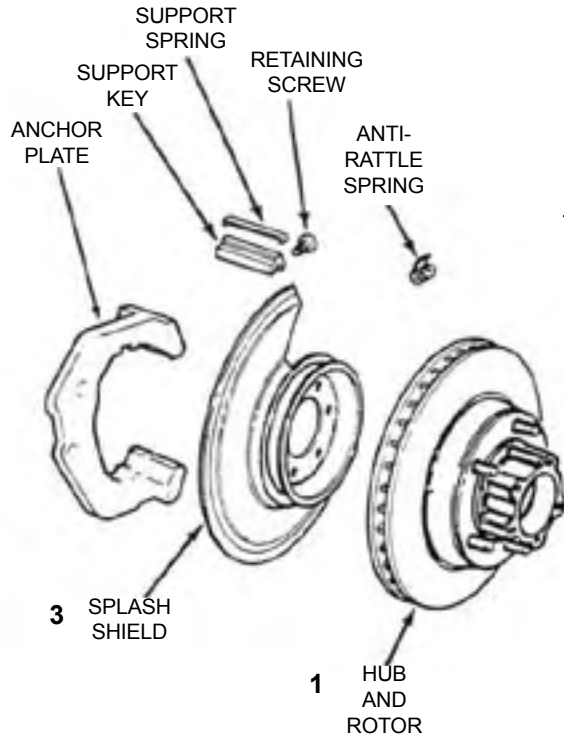

1 BRAKE ROTORS (front):

DESCRIPTION	PART #
1977-78 CJ 1-1/8" THICK (rotor only)	16702.01
1978-86 CJ 7/8" THICK (rotor only)	16702.02
1987-89 WRANGLER (rotor only)	16702.03
1990-99 WRANGLER (rotor only)	16702.04
2000-06 WRANGLER (front rotor)	16702.05
1977-81 SJ CHEROKEE, WAGONEER (rotor only)	16702.06
1984-89 CHEROKEE 4WD (rotor only)	16702.03
1990-01 CHEROKEE 4WD (rotor only)	16702.04
2000-01 CHEROKEE (front rotor)	16702.05
1986-93 CHEROKEE 2WD	16702.07
1993-98 GRAND CHEROKEE	16702.04
1999-04 GRAND CHEROKEE	16702.08
2005-09 GRAND CHEROKEE*	16702.10
2002-07 LIBERTY	16702.09

*Except SRT8

2 BRAKE ROTORS (rear):

DESCRIPTION	PART #
2003-06 WRANGLER, BRAKE ROTOR REAR	16703.03
1993-98 GRAND CHEROKEE W/ REAR DISC BRAKE	16703.01
1999-04 GRAND CHEROKEE W/ REAR DISC BRAKE	16703.02
2002-07 LIBERTY, BRAKE ROTOR REAR	16703.03

3 BRAKE SPLASH SHIELD (pair):

DESCRIPTION	PART #
1976-78 CJ W/ 6 BOLT CALIPER PLATES, (black powder)	11212.01
1976-78 CJ W/ 6 BOLT CALIPER PLATES, (stainless steel)	11212.01
1978-86 CJ W/ 2 BOLT CALIPER PLATES, (black powder)	11212.02
1978-86 CJ W/ 2 BOLT CALIPER PLATES, (stainless steel)	11212.02

4 BRAKE CALIPERS:

DESCRIPTION	PART #
1977-78 CJ W/ 6 BOLT BRACKET, (reman), LEFT	16744.01
1977-78 CJ W/ 6 BOLT BRACKET, (reman), RIGHT	16744.02
1978-81 CJ W/ 2 BOLT BRACKET, (reman), LEFT	16744.03
1978-81 CJ W/ 2 BOLT BRACKET, (reman), RIGHT	16744.04
1982-86 CJ, (remanufactured), LEFT	16744.07
1982-86 CJ, (remanufactured), RIGHT	16744.06
1987-89 WRANGLER, (remanufactured), LEFT	16744.07
1987-89 WRANGLER, (remanufactured), RIGHT	16744.06
1990-06 WRANGLER, RIGHT	16745.02
1990-06 WRANGLER, LEFT	16745.01
1984-89 CHEROKEE, (remanufactured), LEFT	16744.07
1984-89 CHEROKEE, (remanufactured), RIGHT	16744.06
1990-01 CHEROKEE 4WD, RIGHT	16745.02
1990-01 CHEROKEE 4WD, LEFT	16745.01
1993-98 GRAND CHEROKEE, RIGHT	16745.02
1993-98 GRAND CHEROKEE, LEFT	16745.01
2002-07 LIBERTY CALIPER FRONT BRAKE	RIGHT 16745.04 LEFT 16745.05
1999-04 GRAND CHEROKEE w/AKEBONO CALIPER FRONT BRAKE	RIGHT 16745.06 LEFT 16745.07

5 BRAKE CALIPER PISTON & SEAL KITS (per caliper)

DESCRIPTION	PART #
1977-78 CJ WITH 6-BOLT CALIPER PLATE, PISTON, SEAL & BOOT	16747.01
1978-81 CJ WITH 2-BOLT CALIPER PLATE, PISTON, SEAL & BOOT	16747.02
1982-86 CJ, SEAL KIT (WITHOUT PISTON)	16746.01
1982-86 CJ, PISTON, SEAL & BOOT	16747.03
1987-89 WRANGLER, PISTON, SEAL & BOOT	16747.03
1987-06 WRANGLER, SEAL KIT (W/O PISTON)	16746.01
1990-06 WRANGLER, PISTON, SEAL & BOOT	16747.04
1984-89 CHEROKEE, PISTON, SEAL & BOOT	16747.03
1984-01 CHEROKEE, SEAL KIT (W/O PISTON)	16746.01
1990-01 CHEROKEE, PISTON, SEAL & BOOT	16747.04
1993-98 GRAND CHEROKEE, SEAL KIT (W/O PISTON)	16746.01
1993-98 GRAND CHEROKEE, PISTON, SEAL & BOOT	16747.04
1999-2002 GRAND CHEROKEE, w/ TEVES CALIPER PISTON, SEAL & BOOT	16747.05
2002-06 LIBERTY, PISTON, FRONT CALIPER	16746.50
2002-06 LIBERTY, CALIPER SEAL, FRONT (RH=LH)	16746.02



DISC BRAKES

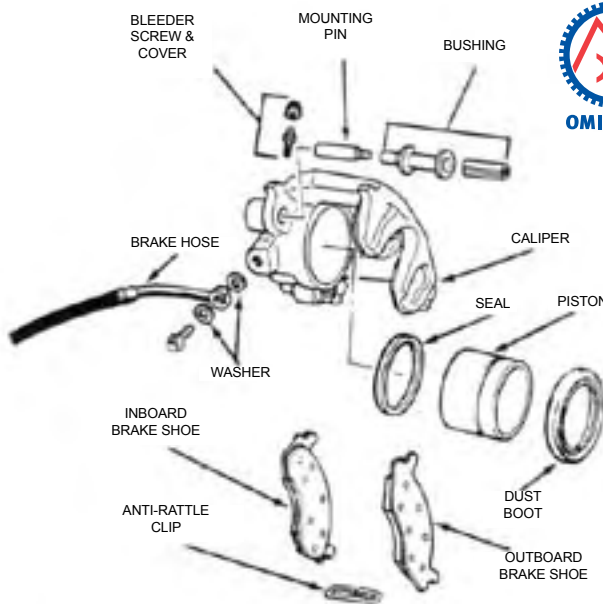

1 BRAKE CALIPER HARDWARE KITS (part #'s are for each side)

DESCRIPTION	PART #
1976-78 CJ WITH 6 BOLT CALIPER PLATE	16748.01
1978-81 CJ WITH 2 BOLT CALIPER PLATE	16748.02
1982-86 CJ	16748.03
1987-89 WRANGLER	16748.03
1990-06 WRANGLER	16748.04
1984-89 CHEROKEE	16748.03
1990-01 CHEROKEE	16748.04
1993-98 GRAND CHEROKEE	16748.04
1999-04 GRAND CHEROKEE	16748.05

2 BRAKE CALIPER BOLTS

DESCRIPTION	PART #
1976-81 CJ	16749.01
1982-86 CJ	16749.02
1987-89 WRANGLER	16749.02

3 BRAKE CALIPER PINS

DESCRIPTION	PART #
1990-06 WRANGLER	16749.09
1990-01 CHEROKEE	16749.09
1993-98 GRAND CHEROKEE	16749.09

4 BRAKE CALIPER BUSHINGS

DESCRIPTION	PART #
1982-86 CJ	16749.05
1987-89 WRANGLER	16749.05
1990-06 WRANGLER	16749.06
1984-89 CHEROKEE	16749.05
1990-01 CHEROKEE	16749.06
1993-98 GRAND CHEROKEE	16749.06

5 BRAKE CALIPER SLEEVES

DESCRIPTION	PART #
1982-86 CJ	16749.07
1987-89 WRANGLER	16749.07
1990-06 WRANGLER	16749.08
1984-89 CHEROKEE	16749.07
1990-01 CHEROKEE	16749.08
1993-98 GRAND CHEROKEE	16749.08

6 BRAKE CALIPER ANTI-RATTLE CLIPS

DESCRIPTION	PART #
1982-06 CJ	16749.04
1987-06 WRANGLER	16749.04
1984-01 CHEROKEE	16749.04
1993-98 GRAND CHEROKEE	16749.04

7 BRAKE CALIPER BLEEDER SCREWS

DESCRIPTION	PART #
1982-86 CJ	16749.03
1987-06 WRANGLER	16749.03
1984-01 CHEROKEE	16749.03
1993-98 GRAND CHEROKEE	16749.03

8 FRONT DISC BRAKE PAD SETS

DESCRIPTION	PART #
1974-91 SJ	16728.05
1976-78 CJ WITH 6 BOLT CALIPER BRACKET	16728.10
1976-78 CJ WITH 6 BOLT CALIPER PLATE	16728.01
1978-81 CJ WITH 2 BOLT CALIPER BRACKET	16728.11
1978-81 CJ WITH 2 BOLT CALIPER PLATE	16728.02
1982-86 CJ, BENDIX	16728.12
1982-86 CJ, SEMI-METALLIC	16728.03
1982-86 CJ, TITANIUM	16728.07
1987-89 WRANGLER, BENDIX	16728.12
1987-89 WRANGLER, SEMI-METALLIC	16728.03
1987-89 WRANGLER, TITANIUM	16728.07
1990-06 WRANGLER, BENDIX	16728.14
1990-06 WRANGLER, SEMI-METALLIC	16728.04
1990-06 WRANGLER, TITANIUM	16728.08
1984-89 CHEROKEE, BENDIX	16728.12
1984-89 CHEROKEE, SEMI-METALLIC	16728.03
1984-89 CHEROKEE, TITANIUM	16728.07
1990-01 CHEROKEE 4WD, SEMI-METALLIC	16728.04
1990-01 CHEROKEE, BENDIX	16728.14
1990-01 CHEROKEE, TITANIUM	16728.08
1990-96 CHEROKEE 2WD, SEMI-METALLIC	16728.03
1993-98 GRAND CHEROKEE SEMI-METALLIC	16728.04
1993-98 GRAND CHEROKEE, BENDIX	16728.14
1993-98 GRAND CHEROKEE, TITANIUM	16728.08
1999-02 GRAND CHEROKEE W/ TEVES CALIPER, TITANIUM	16728.06
1999-02 GRAND CHEROKEE W/ TEVES CALIPER, TITANIUM	16728.13
2002-07 LIBERTY	16728.09

9 REAR DISC BRAKE PAD SETS

DESCRIPTION	PART #
1997-01 WRANGLER W/ REAR DISC BRAKE, BENDIX	16729.08
1997-01 WRANGLER WITH REAR DISC BRAKE, SEMI-METALLIC	16729.11
1997-01 WRANGLER W/ REAR DISC BRAKE, TITANIUM	16729.05
2003-06 WRANGLER, BENDIX	16729.10
2003-06 WRANGLER REAR BRAKE PAD SET, WITH REAR DISC BRAKE	16729.06
2007-10 WRANGLER	16279.10
1997-01 CHEROKEE WITH REAR DISC BRAKE, BENDIX	16729.08
1997-01 CHEROKEE WITH REAR DISC BRAKE, SEMI-METALLIC	16729.11
1997-01 CHEROKEE W/ REAR DISC BRAKE, TITANIUM	16729.05
1994 GRAND CHEROKEE WITH REAR DISC BRAKE, SEMI-METALLIC	16729.02
1995-98 GRAND CHEROKEE, REAR, BENDIX	16729.08
1995-98 GRAND CHEROKEE, REAR SEMI-METALLIC	16729.11
1995-98 GRAND CHEROKEE, REAR TITANIUM	16729.05
1999-04 GRAND CHEROKEE W/ REAR DISC BRAKE, BENDIX	16729.09
1999-04 GRAND CHEROKEE, REAR TITANIUM	16729.04
2005-07 GRAND CHEROKEE (except w/ Dana 44)	16279.08
2006-07 GRAND CHEROKEE with Dana 44	16279.09
2003-06 LIBERTY REAR BRAKE PAD SET, WITH REAR DISC BRAKE	16729.07

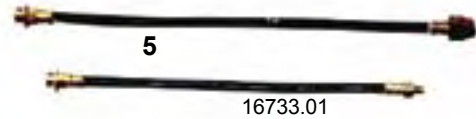
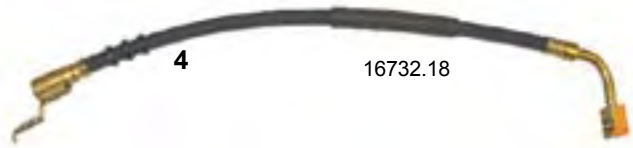
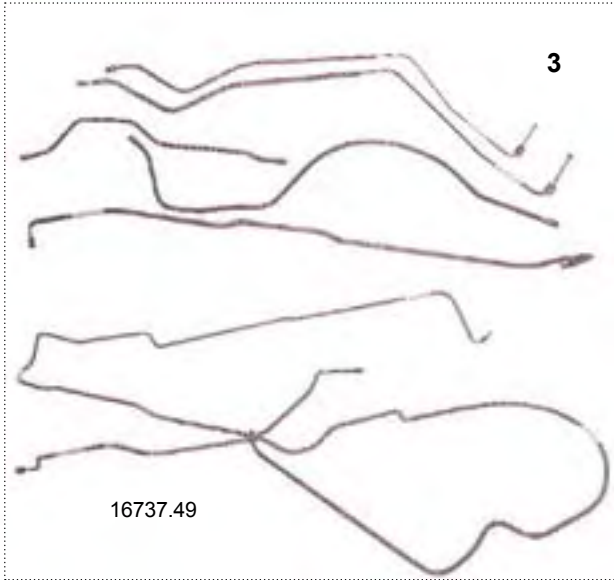

1 BRAKE LINE COILS & FITTING KITS (in O.E. steel)

DESCRIPTION	PART #
13/16" X 0.028 TUBE, 25' COIL W/ 16 ASSORTED NUTS	16737.80
1/4" X 0.028 TUBE, 25' COIL W/ 14 ASSORTED NUTS	16737.81
5/16" X 0.028 TUBE, 25' COIL W/ 10 ASSORTED NUTS	16737.82
3/8" X 0.028 TUBE, 25' COIL W/ 6 ASSORTED NUTS	16737.83

2 EARLY MODEL STEEL BRAKE LINE SETS

DESCRIPTION	PART #
1941-42 EARLY MB FULL LINE	16737.01
1943-45 MB STD & GPW FULL LINE	16737.02
1946-56 FRONT AXLE BRAKE LINE	16737.06
1946-47 CJ2A EARLY WITH REAR DANA-41 AXLE, REAR AXLE BRAKE LINE	16737.07
1948-55 CJ2A, CJ3A & VERY EARLY CJ3B, W/ REAR DANA-44 AXLE, REAR AXLE LINE SET	16737.08
1946-47 EARLY CJ2A, FRAME LINE SET	16737.09
1948-55 CJ2A LATE, CJ3A, EARLY CJ3B, FRAME LINE SET	16737.10
1951-53 M38 FULL LINE	16737.03
1953-68 M38A1 FULL LINE	16737.04
1955-65 CJ5 FULL LINE w/ 9" REAR DRUM	16737.05
1955-65 CJ5 FULL LINE w/ 10" REAR DRUM (NEW)	16737.12
CJ3A (late model), CJ3B (late model) FRAME BRAKE LINE SET	16737.11

3 STAINLESS STEEL BRAKE LINE SETS

(SEAMLESS 304 GRADE STAINLESS STEEL, DOUBLE ANNEALED TUBING)

P=POWER, LP=LESS POWER, DR= FRONT DRUM BRAKE, DS=FRONT DISC BRAKE

DESCRIPTION	PART #
1967-68 CJ5, LP, DR	16737.30
1969-71 CJ5, LP, DR	16737.31
1972-73 CJ5, LP, DR	16737.32
1974-75 CJ5, LP, DR	16737.33
1976-78 CJ5, LP, DR	16737.34
1976-78 CJ5, P, DR	16737.35
1977-80 CJ5, LP, DS	16737.36
1977-80 CJ5, P, DS	16737.37
1981-83 CJ5, LP, DS	16737.38
1981-83 CJ5, P, DS	16737.39
1976-78 CJ7 W/O QUADRATRAC, LP, DR	16737.40
1976-78 CJ7 W/O QUADRATRAC, P, DR	16737.41
1976-80 CJ7 W/O QUADRATRAC, LP, DS	16737.42
1976-80 CJ7 W/O QUADRATRAC, P, DS	16737.43
1981-86 CJ7 W/O QUADRATRAC, LP, DS	16737.44
1981-86 CJ7 W/O QUADRATRAC, P, DS	16737.45
1976-79 CJ7 W/ QUADRATRAC, LP, DR	16737.46
1976-79 CJ7 W/ QUADRATRAC, P, DR	16737.47
1976-79 CJ7 W/ QUADRATRAC, LP, DS	16737.48
1976-79 CJ7 W/ QUADRATRAC, P, DS	16737.49
87-95 WRANGLER, DS, WITHOUT ABS	16737.50
97-06 WRANGLER 4.0L	16737.51

4 FRONT REPLACEMENT BRAKE HOSES

DESCRIPTION	PART #
1941-71 FRONT "S" LINE	16732.50
1941-45 MB, BRAKE TUBE TO FRONT WHEEL, 6"	16732.01
1941-45 MB, CENTER 11"	16732.02
1945-66 CJ, BRAKE TUBE TO FRONT WHEEL, 6"	16732.01
1945-66 CJ, CENTER 11"	16732.02
1966-71 CJ WITH 10" BRAKE 11" LEFT OR RIGHT	16732.03
1972-73 CJ WITH 11" DRUM BRAKE LEFT OR RIGHT	16732.04
1974-77 CJ WITH 11" DRUM BRAKE LEFT OR RIGHT	16732.05
1976-78 CJ WITH DISC BRAKE LEFT OR RIGHT	16732.06
1978-81 CJ WITH DISC BRAKE LEFT OR RIGHT	16732.07
1982-83 CJ5 WITH DISC BRAKE, LEFT OR RIGHT	16732.08
1982-86 CJ7, CJ8 WITH DISC BRAKE LEFT	16732.09
1982-86 CJ7, CJ8 WITH DISC BRAKE RIGHT	16732.10
1987-89 WRANGLER LEFT	16732.11
1987-89 WRANGLER RIGHT	16732.12
1990-95 WRANGLER WITHOUT ABS, LEFT	16732.13
1990-95 WRANGLER WITHOUT ABS, RIGHT	16732.14
1997-06 WRANGLER, W/ OR W/O ABS, LEFT	16732.15
1997-06 WRANGLER, W/ OR W/O ABS, RIGHT	16732.16
1984-89 CHEROKEE LEFT	16732.17
1984-89 CHEROKEE RIGHT	16732.18
1992-01 CHEROKEE, LH	16732.21
1992-01 CHEROKEE, RH (NEW)	16732.24
1974-78 SJ, LEFT OR RIGHT	16732.19

5 REAR REPLACEMENT BRAKE HOSES

DESCRIPTION	PART #
1941-71 MB & CJ BRAKE TUBE 15"	16733.01
1972-75 CJ WITH 11" BRAKE	16733.02
1976-86 CJ	16733.03
1987-89 WRANGLER	16733.05
1990-95 WRANGLER	16733.05
1997-06 WRANGLER WITHOUT DISC BRAKE, REAR	16733.06
1984-89 CHEROKEE	16733.07
1990-91 CHEROKEE	16733.08
1992-01 CHEROKEE	16733.09
1993-98 GRAND CHEROKEE	16733.10

6 MISC. BRAKE HOSE ITEMS

DESCRIPTION	PART #
BRAKE HOSE RETAINING CLIP	16736.01
1977-81 BRAKE HOSE TO CALIPER BOLT	16736.02
1982-99 BRAKE HOSE TO CALIPER BOLT	16736.03
1977-81 CJ, BRAKE HOSE WASHER	16751.09
1982-86 CJ, BRAKE HOSE WASHER	16751.10
1987-01 WRANGLER, BRAKE HOSE WASHER	16751.10

EMERGENCY BRAKE

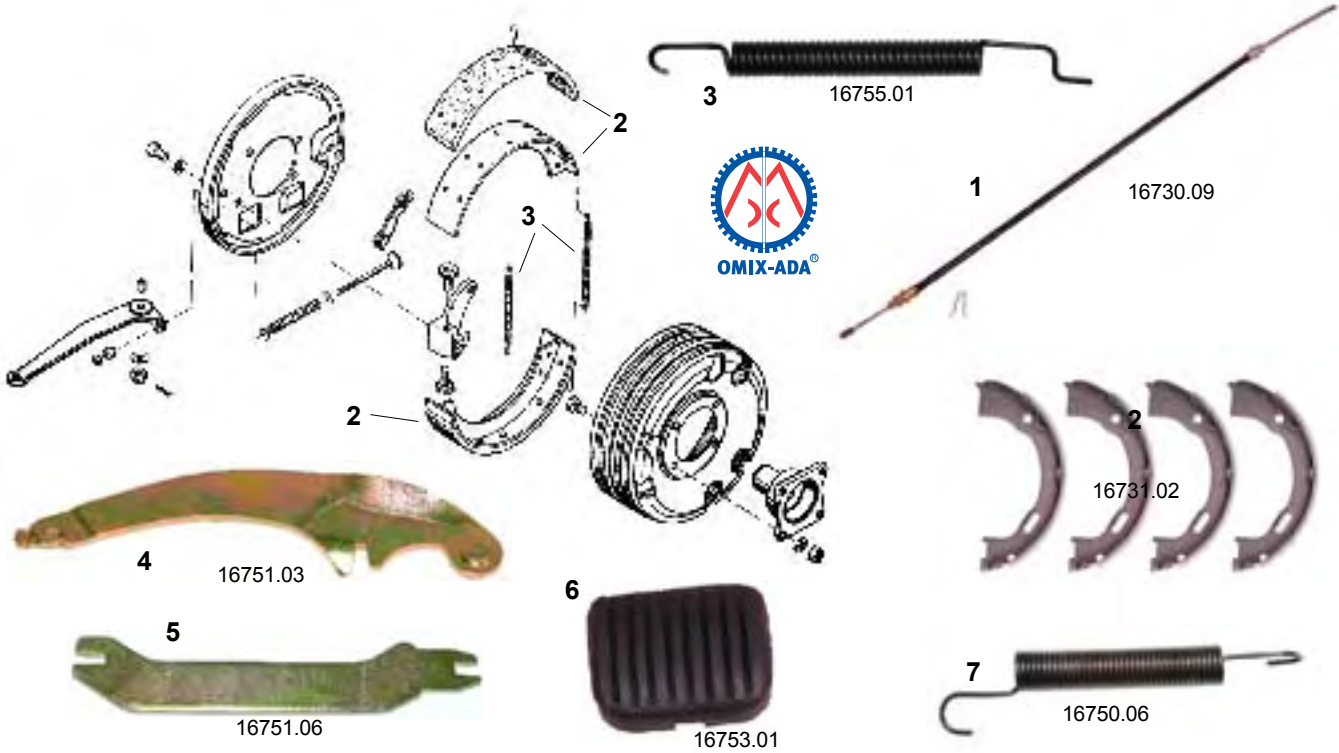

1 EMERGENCY BRAKE CABLES

DESCRIPTION	PART #
1945-49 CJ2A BEFORE s/n 183948, 42.25"	16730.01
1949-53 CJ2A (from s/n183948), CJ3A & ALL 44.5"	16730.02
1955-71 CJ, ALL W/ 63-5/8"	16730.03
1976-78 CJ WITH 11" BRAKE, LEFT REAR	16730.07
1976-78 CJ WITH 11" BRAKE, RIGHT REAR	16730.06
1976-83 CJ5, FRONT PEDAL TO EQUALIZER	16730.10
1976-86 CJ, EQUALIZER	16756.01
1976-86 CJ7, FRONT PEDAL TO EQUALIZER	16730.11
1978-86 CJ WITH 10" BRAKE, LEFT REAR	16730.09
1978-86 CJ WITH 10" BRAKE, RIGHT REAR	16730.08
1981-86 CJ8, FRONT PEDAL TO EQUALIZER	16730.12
1987-89 WRANGLER, LEFT REAR	16730.19
1987-89 WRANGLER, RIGHT REAR	16730.18
1987-90 WRANGLER, FRONT PEDAL TO EQUALIZER	16730.17
1987-95 WRANGLER, CLIP	16751.11
1990 WRANGLER, LEFT REAR	16730.21
1990 WRANGLER, RIGHT REAR	16730.20
1991-95 WRANGLER, FRONT PEDAL TO EQUALIZER	16730.22
1991-95 WRANGLER, LEFT REAR	16730.25
1991-95 WRANGLER, RIGHT REAR	16730.24
1997-06 WRANGLER WITHOUT REAR DISC BRAKE, REAR, CABLE, FITS EITHER SIDE	16730.26
1997-06 WRANGLER, FRONT	16730.33
2003-05 WRANGLER WITH DISC BRAKES WITH ABS, REAR LEFT	16730.47
RIGHT	16730.48
2003-06 WRANGLER W/ REAR DRUM BRAKE WITH ABS, REAR RH, CABLE, LH=RH	16730.26
2004-05 WRANGLER UNLIMITED WITH REAR DISC & WITH ABS, RIGHT REAR	16730.52
1984-86 CHEROKEE, LEFT & RIGHT	16730.32
1987-89 CHEROKEE, LEFT & RIGHT	16730.27
1990-91 CHEROKEE, LEFT & RIGHT	16730.28
1992-96 CHEROKEE, LEFT & RIGHT	16730.29
1997-01 CHEROKEE, LEFT & RIGHT	16730.30
1993-98 GRAND CHEROKEE, FRONT	16730.31
1999-01 GRAND CHEROKEE, LEFT REAR	16730.39
1999-01 GRAND CHEROKEE, RIGHT REAR	16730.40
1999-04 GRAND CHEROKEE, FRONT	16730.34
2005-07 GRAND CHEROKEE, FRONT	16730.35
2005-07 GRAND CHEROKEE, REAR LH/RH	16730.36
2002 LIBERTY, LEFT REAR	16730.41
2002 LIBERTY, RIGHT REAR	16730.42
2003-05 LIBERTY, LEFT REAR	16730.45
2003-05 LIBERTY, RIGHT REAR	16730.46
POSTAL JEEP, EMERGENCY BRAKE	16730.13

2 EMERGENCY BRAKE SHOES

DESCRIPTION	PART #
1942-45 MB, EMERGENCY BRAKE SHOE (pair)	16731.01
1950-52 M38, EMERGENCY BRAKE SHOE (pair)	16731.01
1945-71 CJ, EMERGENCY BRAKE SHOE (pair)	16731.01
1995-98 GRAND CHEROKEE WITH 4 WHEEL DISC BRAKE, (set)	16731.02
1999-04 GRAND CHEROKEE, (pair)	16731.05
2005-07 GRAND CHEROKEE	16731.06
2002-04 LIBERTY WITH 4 WHEEL DISC BRAKE	16731.03

3 EMERGENCY BRAKE SPRINGS

DESCRIPTION	PART #
1942-45 MB, LEVER END SPRING	16755.01
1942-45 MB, ADJUSTING END SPRING	16755.02
1950-52 M38, LEVER END SPRING	16755.01
1950-52 M38, ADJUSTING END SPRING	16755.02
1945-71 CJ, LEVER END SPRING	16755.01
1945-71 CJ, ADJUSTING END SPRING	16755.02

4 EMERGENCY BRAKE LEVERS

DESCRIPTION	PART #
1972-78 CJ WITH 11" BRAKE, RIGHT SIDE	16751.04
1972-78 CJ WITH 11" BRAKE, DRIVER SIDE	16751.03
1987-89 WRANGLER, RIGHT	16751.12
1987-89 WRANGLER, LEFT	16751.13
1984-89 CHEROKEE, RIGHT	16751.12
1984-89 CHEROKEE, LEFT	16751.13

5 EMERGENCY BRAKE EQUALIZER BARS

DESCRIPTION	PART #
1972-78 CJ WITH 11" BRAKE, LH=RH	16751.05
1978-86 CJ WITH 10" BRAKE	16751.06
1987-89 WRANGLER WITH 10" BRAKE	16751.06
1987-92 WRANGLER	16751.14
1987-90 CHEROKEE	16751.14

6 BRAKE PEDAL PADS

DESCRIPTION	PART #
1946-71 CJ BRAKE PEDAL RUBBER PAD	16753.01
1972-86 CJ, BRAKE PEDAL RUBBER PAD	16753.01
1972-86 CJ, EMERGENCY BRAKE PEDAL PAD	16751.07
1987-95 WRANGLER, EMERGENCY BRAKE PEDAL PAD	16751.07
1987-93 WRANGLER WITH AUTOMATIC TRANSMISSION, PEDAL PAD	16753.02
1987-06 WRANGLER WITH MANUAL TRANSMISSION, PEDAL PAD	16753.03
1987-93 CHEROKEE WITH AUTOMATIC TRANSMISSION, PEDAL PAD	16753.02
1987-01 CHEROKEE WITH MANUAL TRANSMISSION, PEDAL PAD	16753.03

7 BRAKE PEDAL PARTS

DESCRIPTION	PART #
1941-71 CJ, BRAKE PEDAL ARM	16750.04
1941-71 CJ, BRAKE PEDAL RETURN SPRING	16750.06
1941-71 CJ, BRAKE PEDAL IDLER SHAFT	16750.07
1941-71 ALL MODELS PEDAL DRAFT PAD KIT	16750.09
MB, GPW BRAKE PEDAL	16750.12



CLUTCH



CLUTCH KITS

DESCRIPTION	PART #	PART #	PART #
	CLUTCH KIT REGULAR	CLUTCH KIT MASTER	CLUTCH KIT JUNIOR
CJ	16901.01	16902.01	--
1946-67 CJ, 4-134, 8 1/2"	16901.02	16902.02	--
1967-71 CJ, 4-134, 9 1/4"	16901.05	16902.05	--
1972-75 CJ 11"	16901.06	16902.06	--
1972-75 CJ, 6 OR 8 CYLINDER, 10.50"	16901.07	16902.07	--
1976-79 CJ, 6 OR 8 CYLINDER, 10.50"	16901.08	16902.08	--
1980-81 CJ, 6 OR 8, CYLINDER 10.50"	16901.05	16902.05	--
1980-83 CJ 11"	16901.03	16902.03	--
1980-83 CJ, 4 CYLINDER GM 151	16901.09	16902.09	--
1982-86 CJ, 6 OR 8 CYLINDER, 10.50"	16901.04	16902.04	--
1983-86 CJ, 4 CYLINDER AMC 150	16901.15	16902.15	16903.03
Wrangler			
1987-89 6 CYL WRANGLER WITH PEUGEOT TRANS	16901.10	16902.10	--
1987-90 4 CYLINDER WRANGLER	16901.16	16902.16	16903.03
1989-91 6 CYLINDER WRANGLER W/ AISIN TRANS	16901.11	16902.11	16903.01
1991-92 4 CYLINDER WRANGLER	16901.16	16902.17	16903.03
1992 6 CYLINDER WRANGLER	16901.12	16902.12	16903.01
1993 4 CYLINDER WRANGLER	16901.17	16902.18	16903.03
1993 6 CYLINDER WRANGLER	16901.13	16902.13	16903.01
1994-02 4 CYLINDER WRANGLER	16901.18	16902.19	16903.03
1994-99 6 CYLINDER WRANGLER	16901.19	--	16903.04
2001-04 6 CYLINDER 4.0L WRANGLER	--	--	16903.07
2003-06 4 CYLINDER WRANGLER	16901.15	16902.15	16903.03
Cherokee			
1987-89 6 CYL CHEROKEE WITH PEUGEOT TRANS	16901.10	16902.10	--
1987-90 4 CYLINDER CHEROKEE	16901.16	16902.16	16903.03
1989-91 6 CYLINDER CHEROKEE W/ AISIN TRANS	16901.11	16902.11	16903.01
1991-92 4 CYLINDER CHEROKEE	--	--	16903.02
1991-96 4 CYLINDER 2.1L CHEROKEE DIESEL	16901.16	16902.17	16903.03
1992 6 CYLINDER CHEROKEE	16901.12	16902.12	16903.01
1993 4 CYLINDER CHEROKEE	16901.17	16902.18	16903.03
1993 6 CYLINDER CHEROKEE	16901.13	16902.13	16903.01
1994-01 4 CYLINDER CHEROKEE	16901.18	16902.19	16903.03
1994-99 6 CYLINDER CHEROKEE	16901.19	--	16903.04
2001-06 6 CYLINDER 4.0L CHEROKEE	16901.18	16902.19	16903.03
Grand Cherokee			
1993-98 6 CYLINDER GRAND CHEROKEE	16901.21	--	16903.06
Liberty			
2002-04 4 CYLINDER 2.4L LIBERTY	16901.20	--	16903.05
2002-04 6 CYLINDER 3.7L LIBERTY	--	--	16903.05
2003-04 4 CYLINDER LIBERTY	--	--	16903.07

REGULAR CLUTCH KIT = COVER, DISC AND BEARING W/SLEEVE OR HYDRAULIC CONTROL UNIT

MASTER CLUTCH KIT = REGULAR KIT (ABOVE) + FORK AND PILOT BEARING

JUNIOR CLUTCH KIT = COVER AND DISK ONLY

(FORK NOT REQUIRED WHEN SLAVE CYLINDER USED)

CLUTCH PARTS

DESCRIPTION	COVER	DISC	BEARING
	PART #	PART #	PART #
CJ			
1946-67 CJ, 4-134, 8 1/2" CLUTCH	16904.01	16905.01	16906.01
1966-71 CJ 225 V6	--	--	16906.10
1967-71 CJ, 4-134, 9 1/4" CLUTCH	16904.02	16905.02	16906.01
1972-75 CJ, 11" CLUTCH 6 OR 8 CYL	16904.05	16905.05	16906.04
1972-75 CJ, 6 OR 8 CYLINDER, 10.50" CLUTCH	16904.06	16905.06	16906.05
1976-79 CJ, 6 OR 8 CYLINDER, 10.50" CLUTCH	16904.06	16905.13	16906.04
1980-81 CJ, 6 OR 8 CYLINDER, 10.50" CLUTCH	16904.06	16905.06	16906.04
1980-83 CJ, 11" CLUTCH 6 OR 8 CYL	16904.05	16905.05	16906.04
1980-83 CJ, 4 CYLINDER GM 151	16904.03	16905.03	16906.02
1982-86 CJ, 6 OR 8 CYLINDER, 10.50" CLUTCH	16904.07	16905.06	16906.04
1983-86 CJ, 4 CYLINDER AMC 150	16904.04	16905.04	16906.03
Wrangler			
1987-89 6 CYLINDER WRANGLER W/ PEUGEOT TRANS	16904.12	16905.06	16909.03
1987-90 4 CYLINDER WRANGLER	16904.08	16905.04	16906.04
1990-92 6 CYLINDER WRANGLER W/ AISIN TRANS	16904.12	16905.06	16909.05
1991-92 4 CYLINDER WRANGLER	16904.09	16905.07	16906.04
1993 4 CYLINDER WRANGLER	16904.09	16905.07	16909.06
1993 6 CYLINDER WRANGLER	16904.12	16905.06	16909.06
1994-01 4 CYLINDER WRANGLER	16904.09	16905.07	16909.04
1994-99 6 CYLINDER WRANGLER	16904.12	16905.06	16906.06
2002-06 6 CYLINDER 4.0L WRANGLER	16904.13	16905.10	16906.06
2003-04 4 CYLINDER WRANGLER	16904.18	16904.15	16906.06
2007-10 6 CYLINDER WRANGLER (NEW)	16904.18	--	16906.06
Cherokee			
1987-89 6 CYLINDER CHEROKEE W/ PEUGEOT TRANS	16904.12	16905.06	16909.03
1987-90 4 CYLINDER CHEROKEE	16904.08	16905.04	16906.04
1990-92 6 CYLINDER CHEROKEE W/ AISIN	16904.12	16905.06	16909.05
1991-92 4 CYLINDER CHEROKEE	16904.09	16905.07	16906.04
1991-96 4 CYLINDER 2.1L CHEROKEE DIESEL	16904.10	16905.08	--
1993 4 CYLINDER CHEROKEE	16904.09	16905.07	16909.06
1993 6 CYLINDER CHEROKEE	16904.12	16905.06	16909.06
1994-01 4 CYLINDER CHEROKEE	16904.09	16905.07	16909.04
1994-99 6 CYLINDER CHEROKEE	16904.12	16905.06	16906.06
2000-01 6 CYLINDER 4.0L CHEROKEE	16904.13	16905.10	16906.06
Grand Cherokee			
1993-98 6 CYLINDER GRAND CHEROKEE	16904.12	16905.06	16906.06
Liberty			
2002-06 6 CYLINDER 3.7L LIBERTY	16904.14	16905.11	16906.06
2007-08 6 CYLINDER 3.8L LIBERTY	--	--	16906.06
2002-04 4 CYLINDER 2.4L LIBERTY	16904.11	16904.15	16909.04

CLUTCH AND FLYWHEEL PARTS



1 CLUTCH MASTER & SLAVE CYLINDER KIT

DESCRIPTION	PART #
1994-95 WRANGLER (4 or 6 cylinder)	16907.01
1997-04 WRANGLER (4 or 6 cylinder) (left hand drive)	16907.02
1997-99 WRANGLER (right hand drive)	16907.03
2000-01 WRANGLER (right hand drive)	16907.04
1994-96 CHEROKEE (4 or 6 cylinder)	16907.05
1994-96 CHEROKEE (4 or 6 cylinder) (right hand drive)	16907.06
1998-99 CHEROKEE (4 or 6 cylinder) (left hand drive)	16907.08
2000-01 CHEROKEE (4 or 6 cylinder) (left hand drive)	16907.09
1997-01 CHEROKEE DIESEL (right hand drive)	16907.10
2000-01 CHEROKEE (4 or 6 cylinder) (right hand drive)	16907.11
1993-98 GRAND CHEROKEE (6 or 8 cylinder)	16907.12

2 CLUTCH MASTER CYLINDERS

DESCRIPTION	PART #
1980-86 6 OR 8 CYLINDER CJ	16908.01
1987-90 4 OR 6 CYLINDER WRANGLER	16908.02
1991-95 4 OR 6 CYLINDER WRANGLER (master only)	16908.03
1994-96 4 OR 6 CYLINDER WRANGLER (master only)	16908.04
1997-04 WRANGLER	16908.11
1984-85 4 CYLINDER CHEROKEE	16908.05
1984 V6 CHEROKEE	16908.05
1986 4 CYLINDER CHEROKEE	16908.06
1985-86 V6 CHEROKEE	16908.06
1985-86 DIESEL CHEROKEE	16908.06
1987-90 4 OR 6 CYLINDER CHEROKEE	16908.07
1987-90 DIESEL CHEROKEE	16908.07
1991-93 CHEROKEE	16908.08
1994-96 CHEROKEE (master only)	16908.09
1997-01 CHEROKEE	16908.11
1993-96 GRAND CHEROKEE (w/o slave CYLINDER)	16908.10

3 CLUTCH SLAVE CYLINDERS

DESCRIPTION	PART #
1976-83 4 CYLINDER (GM engine) OR DIESEL CJ	16909.01
1983-86 4 CYLINDER CJ AMC 150	16909.02
1984-86 4 OR 6 (2.8L) CHEROKEE	16909.02
1984-96 4 CYLINDER DIESEL CHEROKEE	16909.01
1980-86 6 OR 8 CYLINDER CJ	16909.01
1987-92 4 CYLINDER WRANGLER	16909.04
1987-89 6 CYLINDER WRANGLER (w/ Peugeot TRANS)	16909.03
1989-92 6 CYLINDER WRANGLER (w/ Aisin TRANS)	16909.05
1993 4 OR 6 CYLINDER WRANGLER	16909.06
1994-99 WRANGLER	16909.07
1997-01 WRANGLER (right hand drive)	16909.08
1987-92 4 CYLINDER CHEROKEE	16909.04
1987-89 6 CYLINDER CHEROKEE (w/ Peugeot TRANS)	16909.03
1989-92 6 CYLINDER CHEROKEE (w/ Aisin TRANS)	16909.05
1993 4 OR 6 CYLINDER CHEROKEE	16909.06
1994-99 CHEROKEE	16909.07
1994-98 GRAND CHEROKEE	16909.07

4 PILOT BUSHINGS & BEARINGS

DESCRIPTION	PART #
1941-71 4 CYLINDER 134	16910.01
1965-71 6 CYLINDER	16910.09
1980-83 4 CYLINDER CJ WITH GM 151	16910.02
1983-86 4 CYLINDER CJ	16910.03
1972-76 6 OR 8 CYLINDER	16910.04
1976-79 6 OR 8 CYLINDER	16910.05
1982-86 6 OR 8 CYLINDER	16910.06
1987-99 4 CYLINDER WRANGLER	16910.03
1987-91 6 CYLINDER WRANGLER	16910.07
1992-00 6 CYLINDER WRANGLER	16910.08
2003-04 2.4L WRANGLER	16910.11
2001-06 4.0L WRANGLER	16910.12
2000-02 2.5L WRANGLER	16910.12
1984-99 4 CYLINDER CHEROKEE	16910.03
1992-00 6 CYLINDER CHEROKEE	16910.08
1993-98 6 CYLINDER GRAND CHEROKEE	16910.08
1993-96 V8 GRAND CHEROKEE W/ MANUAL TRANS	16910.10
2002-04 2.4L LIBERTY	16910.11
2002-07 3.7L LIBERTY	16910.12

5 FLYWHEEL RING GEARS, MANUAL TRANSMISSION

DESCRIPTION	PART #
1941-49 MB 4-134	16911.01
1945-49 CJ2A 4-134	16911.01
1953-71 CJ 4-134	16911.02
1983-86 4 CYLINDER CJ	16911.03
1987-96 4 CYLINDER WRANGLER	16911.03
1997-02 4 CYLINDER WRANGLER (ALSO FITS 1997-02 2.5L WRANGLER)	16911.03
1984-96 4 CYLINDER CHEROKEE	16911.03
1967-71 V6-225 CJ	16911.04
1965-71 6 CYLINDER SJ	16911.05
1972-86 6 CYLINDER CJ	16911.06
1987-90 6 CYLINDER WRANGLER	16911.06
1991-06 6 CYLINDER WRANGLER	16911.06
1991-01 6 CYLINDER 4.0L CHEROKEE	16911.06
1987-98 6 CYLINDER 4.0L GRAND CHEROKEE	16911.06
1972-81 CJ 8 CYLINDER AMC	16911.06
1972-92 SJ 8 CYLINDER AMC	16911.06

6 FLYWHEELS, MANUAL TRANSMISSION

DESCRIPTION	PART #
1991-02 2.5L ALL	16912.02
1974-79 6 CYLINDER 232 OR 258	16912.03
1982-86 CJ 4.2L	16912.05
1987 4.2L WRANGLER	16912.05
1988-90 4.2L WRANGLER	16912.06
1991-99 4.0L WRANGLER	16912.07
1991-99 4.0L CHEROKEE	16912.07
1972-91 AMC V8 360	16912.08
1972-79 AMC V8 401	16912.09
1972-86 CJ W/ GM V8 CONVERSION, 168 TEETH	16912.10

7 FLEX PLATES, AUTOMATIC TRANSMISSION

DESCRIPTION	PART #
1976-79 CJ 6 CYLINDER 258	16913.01
1976-79 CJ 8-CYLINDER AMC 304	16913.02
1976-79 8-CYLINDER AMC 360	16913.03
1976-79 8-CYLINDER AMC 401	16913.04
1980-86 CJ 6 CYLINDER 258	16913.05
1980-86 CJ 8 CYLINDER 304, 360	16913.06
1980-86 SJ 8 CYLINDER 304, 360	16913.06
DJ POSTAL JEEP APPLICATIONS	16913.07
1970-85 WITH CHEVY V8 CONVERSION	16913.08
1988-93 V8	16913.09
1987-90 4.0L CHEROKEE	16913.11
1991-00 4.0L CHEROKEE	16913.10

8 BELLHOUSINGS AND COMPONENTS

DESCRIPTION	PART #
1976-86 6 OR 8 CYL CJ W/ T150 OR T176 TRANS	16916.01
1980-86 CJ WITH SR4, T4, T5	16916.02
1974-86 6 OR 8 CYLINDER CJ, MANUAL OR AUTO, CLUTCH HOUSING COVER	16917.01
1974-86 6 OR 8 CYLINDER CJ, MANUAL OR AUTO, CLUTCH-ENGINE SPACER	16917.02



OMIX-ADA®

CLUTCH LINKAGE

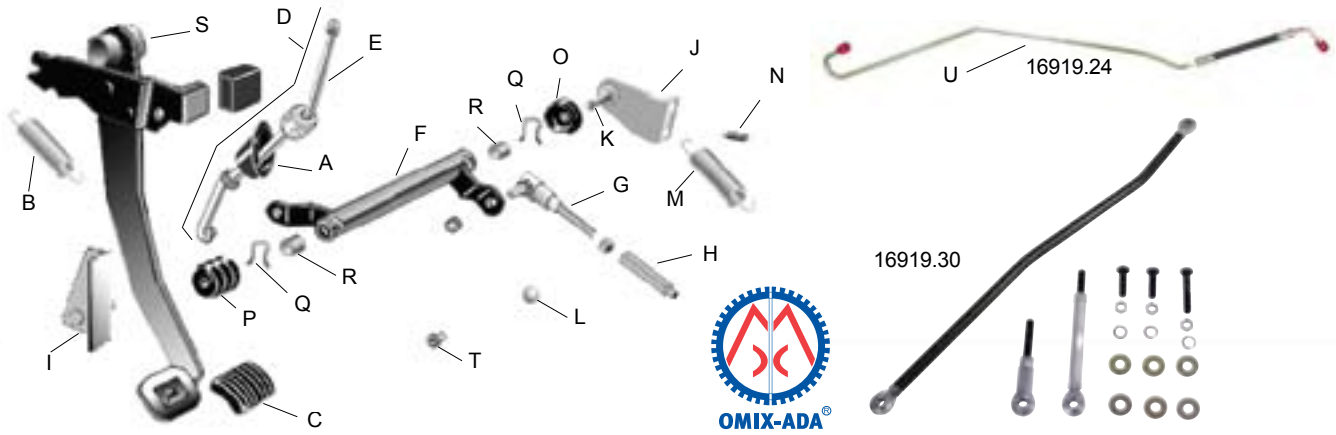

1972-86 CJ CLUTCH LINKAGE COMPONENTS

DESCRIPTION	PART #	DESCRIPTION	PART #
1976-86 BELLCRANK KIT CONTAINS ITEMS: A, E, F, G, H, I, J, K, L, M, N, O, P, & 2 OF BOTH Q & R	16919.01	N 1972-75 6 OR 8 CYL CJ FORK INNER SPRING	16919.15
A 1976-86 ROD BOOT	16919.02	1976-86 6 OR 8 CYL CJ FORK INNER SPRING	16919.16
B 1972-86 CJ CLUTCH PEDAL RETURN SPRING	16919.03	1972-86 CJ BELLCRANK INNER BOOT	16919.17
C 1972-86 ALL CLUTCH PEDAL COVER	16753.01	P 1972-86 CJ BELLCRANK OUTER BOOT	16919.18
D 1972-75 6 OR 8 CYL CJ CLUTCH ROD ASM	16919.04	Q 1972-86 CJ CLIP, BELLCRANK (need 2)	16919.19
E 1976-86 CJ PEDAL TO BELLCRANK ROD	16919.05	R 1972-86 CJ BELLCRANK PLASTIC BUSHING (2 needed)	16919.20
F 1972-75 CJ BELLCRANK	16919.06	S 1972-81 CJ 6 OR 8 CYL CLUTCH PEDAL BEARING (2 needed)	16919.21
G 1976-86 CJ BELLCRANK	16919.07	1981-86 CJ CLUTCH PEDAL BUSHING (2 needed)	16919.22
H 1972-86 CJ LOWER CLUTCH ROD	16919.08	1987-95 WRANGLER CLUTCH PEDAL BUSHING (2 needed)	16919.22
I 1976-86 CJ BODY BRACKET W/PIVOT STUD	16919.09	T 1980-86 4 OR 6 CYL CJ CLUTCH SLAVE PLASTIC PIVOT	16919.23
J 1976-86 CJ BELLHOUSING BRACKET W/STUD	16919.11	U 1980-86 CLUTCH MASTER CYLINDER HOSE (except 4 cyl w/150 AMC engine)	16919.24
K 1972-75 CJ BELLCRANK PIVOT STUD ONLY	16919.12	1980-86 CJ SPRING, SLAVE CYLINDER RETURN	16919.25
L 1972-86 CJ CLUTCH FORK PIVOT BALL	16919.13		
M 1972-86 CJ CLUTCH FORK RETURN OUTER SPRING	16919.14		



1 CLUTCH FORKS

DESCRIPTION	PART #
1941-45 4 CYLINDER 134 MB	16914.01
1950-52 4 CYLINDER 134 M38	16914.01
1952-71 4 CYLINDER 134 M38A1	16914.01
1945-71 4 CYLINDER 134 CJ	16914.01
1947-55 4 CYLINDER 475 4WD UTILITY WAGON	16914.02
1980-83 4 CYLINDER GM 151	16914.03
1972-75 6 OR 8 CYLINDER CJ	16914.05
1976-86 6 OR 8 CYLINDER CJ	16914.06
1994-08 4 OR 6 CYLINDER WRANGLER	16914.07
1994-99 4 OR 6 CYLINDER CHEROKEE	16914.07
1994-98 6 OR 8 CYLINDER GRAND CHEROKEE	16914.07
2002-07 6 OR 8 CYLINDER LIBERTY	16914.07

2 CLUTCH FORK BOOTS

DESCRIPTION	PART #
1972-75 CJ 6 OR 8 CYLINDER	16918.01
1976-79 CJ 6 OR 8 CYLINDER	16918.02
1980-86 CJ 6 OR 8 CYLINDER	16918.03

3 CLUTCH PEDAL COVERS

DESCRIPTION	PART #
1946-71 ALL	16953.01
1946-86 CJ	16753.01
1987-06 WRANGLER	16753.03
1987-01 CHEROKEE	16753.03

4 1941-71 CLUTCH PEDAL

DESCRIPTION	PART #
1941-71 4 ALL, CLUTCH PEDAL	16920.01
1941-71 V6 ALL, CLUTCH PEDAL	16920.01
1941-71 4 ALL, SPRING, PEDAL RETURN	16750.06
1941-71 V6 ALL, SPRING, PEDAL RETURN	16750.06
1946-71 CJ, PEDAL DRAFT PAD KIT	16750.09
MB, GPW CLUTCH FOOT PEDAL	16920.18

5 1941-71 CLUTCH ROD

DESCRIPTION	PART #
1941-45 MB, CLUTCH ROD	16920.14
1946-71 4 CYLINDER CJ CLUTCH ROD	16920.15

6 1941-71 IDLER CROSS SHAFT

DESCRIPTION	PART #
ALL 4 CYL, CROSS SHAFT	16920.04
ALL 4 CYL, CROSS SHAFT HOLD BRACKET	16920.07
ALL 4 CYL, IDLER CROSS SHAFT FELT	16920.08
ALL 4 CYL, IDLER CROSS SHAFT PLATE	16920.09
ALL 4 CYL, IDLER CROSS SHAFT SPRING	16920.10
ALL 4 CYL, IDLER CROSS SHAFT BOOT	16920.11

7 1941-71 BELLCRANK

DESCRIPTION	PART #
1941-45 MB, BELLCRANK KIT	16920.05
1946-71 4 CYLINDER CJ, BELLCRANK KIT	16920.06
1941-45 MB, CABLE, BELLCRANK TO T/0	16920.12
1946-71 ALL 4 CYLINDER CABLE, BELLCRANK TO T/0	16920.13

8 1941-71 MISC. CLUTCH LINKAGE

DESCRIPTION	PART #
1941-71 4 CYLINDER ALL, CLUTCH T/O SPRING	16920.03
1946-71 CJ, CLUTCH LINKAGE YOKE	16920.16

9 1976-86 HD CLUTCH LINKAGE

DESCRIPTION	PART #
76-83 CJs, 76-86 CJs, 81-86 CJs. UP TO 3" BODY LIFT (NEW)	16919.30

RADIATORS

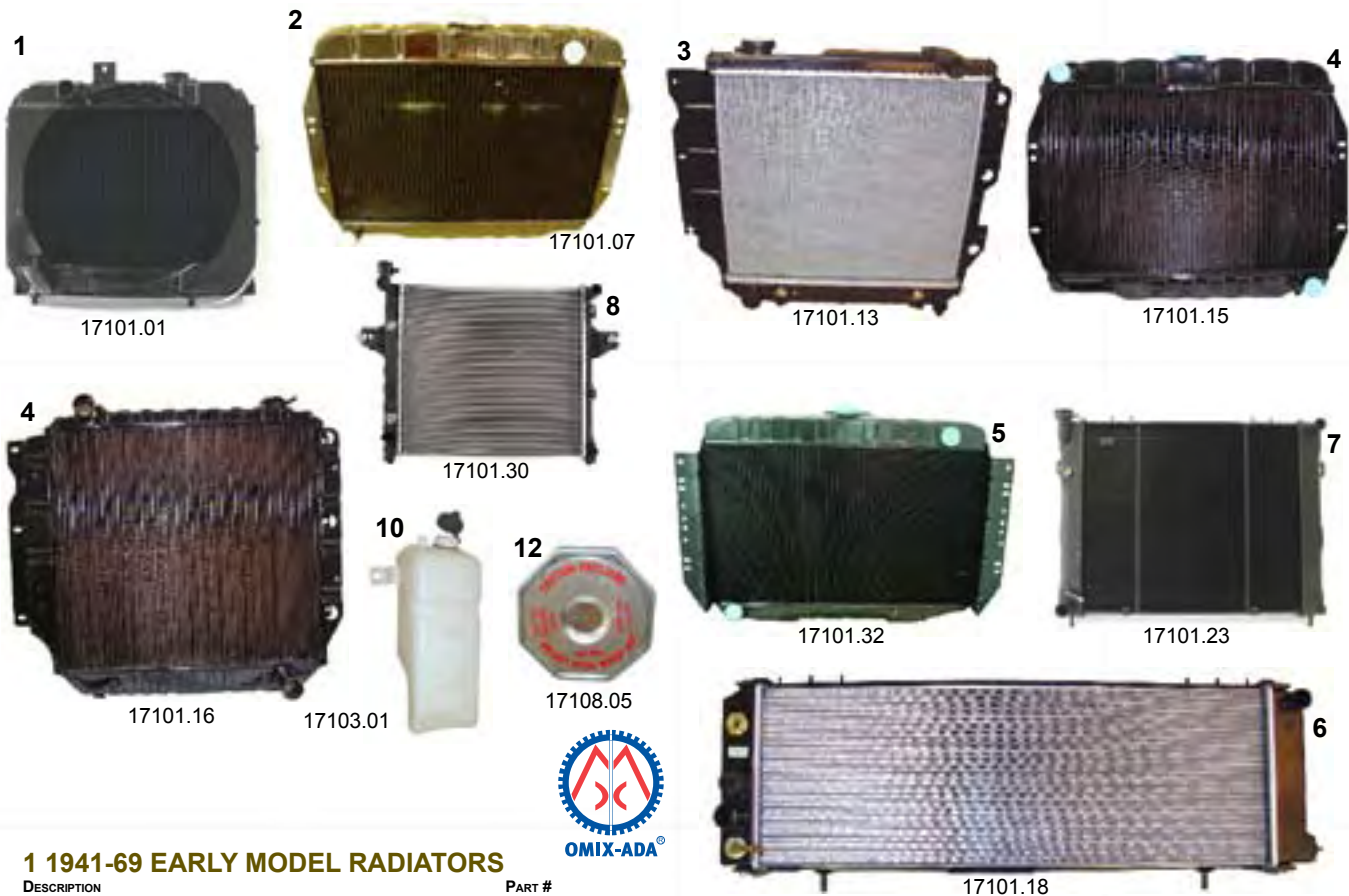

1 1941-69 EARLY MODEL RADIATORS

DESCRIPTION	PART #
1941-45 MB WITH SHROUD, 2 CORE *	17101.01
1945-49 CJ2A WITH SHROUD, 2 CORE *	17101.01
1941-45 MB WITHOUT SHROUD, 2 CORE *	17101.02
1945-49 CJ2A WITHOUT SHROUD, 2 CORE *	17101.02
1955-69 CJ5 4 CYL, 2 CORE	17101.04
1955-69 CJ6 4 CYL, 2 CORE	17101.04
41-45 MB, GPW, DRAIN COCK, 1/8" (NEW)	17470.13

* REQUIRES RADIATOR CAP #17108.02, NOT 17108.01

2 1972-86 CJ & DJ RADIATORS

DESCRIPTION	PART #
1983-86 4 CYL, MANUAL OR AUTO, 2 CORE	17101.05
1983-86 4 CYL (AMC 2.5L) DJ POSTAL	17101.06
1972-86 6 OR 8 CYL, MANUAL OR AUTO, CENTER CAP, 3 CORE (17101.07 won't fit 81-86 6 CYL C.J.'S w/ off-set radiator cap)	17101.07
1981-86 6 OR 8 CYL, MANUAL OR AUTO, CENTER CAP, 2 CORE	17101.09
1981-86 6 CYL, MANUAL OR AUTO, CAP OFF-SET TO DRIVER SIDE, 2 CORE	17101.10
1980-86 CJ, DRAIN COCK (also fits other applications)	17120.01

3 1987-06 WRANGLER RADIATORS

DESCRIPTION	PART #
1987-91 4 OR 6 CYL, W/ or W/O A/C, AUTO or MANUAL	17101.13
1992-95 4 OR 6 CYL, W/ or W/O A/C, AUTO or MANUAL	17101.12
1997-04 4 OR 6 CYL, W/ or W/O A/C, AUTO TRANS	17101.13
1997-06 4 OR 6 CYL W/ MANUAL TRANSMISSION	17101.14

4 1972-95 CJ & WRANGLER GM V8 CONVERSION RADIATORS:

DESCRIPTION	PART #
1972-86 C.J.'S, MANUAL OR AUTO, WITH V8 GM CONVERSION ENGINE, 3 CORE	17101.15
1987-95 WRANGLER'S, MANUAL OR AUTO, W/ GM V8 CONVERSION ENGINE, 3 CORE (NEW)	17101.16

5 1974-91 SJ CHEROKEE RADIATORS

DESCRIPTION	PART #
1974-79 8 CYL, W/ OR W/O A/C, 2 CORE	17101.32
1984-91 8 CYL, W/ OR W/O A/C, 2 CORE	17101.33

6 1984-01 CHEROKEE RADIATOR

DESCRIPTION	PART #
1984-94 4 CYL WITH OR WITHOUT A/C, 2 CORE	17101.17
1990-87 4 CYL DIESEL WITH OR W/O A/C, 2 CORE	17101.17
1984-86 V6 WITH OR WITHOUT A/C, 2 CORE	17101.17
1987-90 6 CYL WITH OR WITHOUT A/C, 2 CORE	17101.18
1991-00 6 CYL WITH 2 CORE RADIATOR	17101.21
1993-94 6 CYL 4.0L WITH AUTO TRANS, RHD	17101.34
1998-01 6 CYL WITH 1 CORE RADIATOR	17101.20
2001 4.0L 6 CYL WITH AUTO TRANSMISSION	17101.35

7 1993-98 GRAND CHEROKEE RADIATORS

DESCRIPTION	PART #
1993-97 6 CYL WITH OR WITHOUT A/C	17101.23
1998 6 CYL	17101.25
1993-97 V8 WITH OR WITHOUT A/C	17101.27
1998 V8	17101.29

8 1999-04 GRAND CHEROKEE RADIATORS

DESCRIPTION	PART #
1999-01 6 CYL	17101.26
1999-00 V8 4.7L ENGINE	17101.30
2001-04 V8 4.7L ENGINE	17101.31

9 2002-05 LIBERTY RADIATORS

DESCRIPTION	PART #
2002-05 3.7L V6 (NEW)	17101.36

10 RADIATOR OVERFLOW BOTTLE & CAP

DESCRIPTION	PART #
1981-86 CJ, KIT (bottle & cap)	17103.01
1987-95 WRANGLER, KIT, (bottle & cap)	17103.01
1987-96 4.0L CHEROKEE (bottle only)	17103.02

11 RADIATOR CLAMPS

DESCRIPTION	PART #
WILL FIT ALL RADIATOR HOSES (4 per vehicle)	17115.01

12 RADIATOR CAPS

* Not for use with Radiators # 17101.01 or 17101.02.
Use Cap # 17108.02 for these applications

DESCRIPTION	PART #
MB & CJ :	
1941-45 MB*	17108.01*
1945-49 CJ2A *	17108.01*
1953-64 CJ3B, F-HEAD 7 LBS PRESSURE	17108.08
1955-81 CJ5, F-HEAD 7 LBS PRESSURE	17108.08
1972-86 CJ	17108.02
WRANGLER:	
1987-93 4 OR 6 CYL (13 lbs pressure)	17108.03
1994-95 4 CYL (16 lbs pressure)	17108.04
1997-06 4 CYL (18 lbs pressure)	17108.05
1997-06 6 CYL (18 lbs pressure)	17108.05
CHEROKEE:	
1984-90 4 CYL (13 lbs pressure)	17108.03
1991-01 4 CYL (16 lbs pressure)	17108.04
1991-95 6 CYL (13 lbs pressure)	17108.03
1996-01 6 CYL (16 lbs pressure)	17108.04
GRAND CHEROKEE:	
1993-98 V8 (18 lbs pressure)	17108.05
1993-96 6 CYL (16 lbs pressure)	17108.04
1997-98 6 CYL (18 lbs pressure)	17108.05
1999-03 6 CYL 4.0L	17108.05
2000-04 V8 4.7L (20 lbs pressure)	17108.06

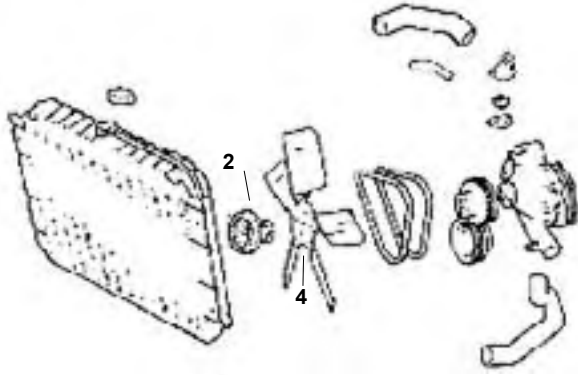

17102.02



17112.50



17105.07



17105.02



17109.01



17102.54



17102.52

1 RADIATOR FAN SHROUDS

DESCRIPTION	PART #
1974-86 6 CYL CJ WITHOUT FACTORY HD COOLING	17102.01
1981-86 6 CYL CJ WITH FACTORY HD COOLING	17102.02
1974-86 V8 CJ	17102.03
1991-95 6 CYL 4.0L WRANGLER (will not fit RHD)	17102.04

2 FAN CLUTCHES

DESCRIPTION	PART #
1980-86 2.5L 4 CYL CJ, WITHOUT SERPENTINE	17105.01
1974-86 6 OR 8 CYL CJ, WITHOUT SERPENTINE	17105.06
1981-86 4.2L 6 CYL CJ, WITH SERPENTINE	17105.02
1987-90 2.5L 4 CYL WRANGLER, W/O SERPENTINE	17105.01
1991-96 2.5L 4 CYL WRANGLER, WITH SERPENTINE	17105.02
1997-99 2.5L 4 CYL WRANGLER (reverse rotation)	17105.03
1997-02 2.5L 4 CYL WRANGLER	17105.10
2003-04 2.4L 4 CYL WRANGLER	17105.10
1987-90 4.2L 6 CYL WRANGLER, W/O SERPENTINE	17105.01
1987-90 4.2L 6 CYL WRANGLER, WITH SERPENTINE	17105.02
1991-99 4.0L 6 CYL WRANGLER (reverse rotation)	17105.04
2000-06 4.0L 6 CYL WRANGLER	17105.12
1984-86 2.5L 4 CYL CHEROKEE, W/O SERPENTINE	17105.01
1984-93 2.5L 4 CYL CHEROKEE, WITH SERPENTINE	17105.02
1994-99 2.5L 4 CYL CHEROKEE (gas models, reverse rotation)	17105.04
2000-01 2.5L CHEROKEE (with or without A/C)	17105.11
1981-86 4.2L 6 CYL CHEROKEE (standard rotation, HD cooling)	17105.05
1987-99 4.0L 6 CYL CHEROKEE (reverse rotation)	17105.03
2001-01 4.0L CHEROKEE	17105.10
1993-98 4.0L 6 CYL GRAND CHEROKEE, WITH MAX COOLING SYSTEM (reverse rotation)	17105.07
1997-98 4.0L 6 CYL GRAND CHEROKEE, W/O MAX COOLING (reverse rotation)	17105.04
1994-98 V8 GRAND CHEROKEE SEVERE DUTY, (reverse rotation)	17105.09
1974-91 4.2L 6 CYL SJ	17105.06
1981-89 4.2L 6 CYL SJ, WITH SERPENTINE	17105.08
1974-91 V8 SJ	17105.06



3 IDLER PULLEYS

DESCRIPTION	PART #
1997-02 2.5L WRANGLER	17112.02
2000-06 4.0L WRANGLER	17112.02
2007-10 3.7L WRANGLER TENSIONER PULLEY (NEW)	17112.51
1991-95 2.5L CHEROKEE	17112.01
1991-93 4.0L CHEROKEE WITH A/C	17112.01
1994-95 4.0L CHEROKEE	17112.01
1996-00 CHEROKEE 2.5L/4.0L, UPPER	17112.04
1996-01 2.5L/4.0L CHEROKEE	17112.02
1993-96 4.0L GRAND CHEROKEE	17112.01
1993-98 5.2L & 5.9L GRAND CHEROKEE, IDLER PULLEY	17112.03
1993-98 5.2L & 5.9L GRAND CHEROKEE, TENSIONER PULLEY (NEW)	17112.06
2007-10 WRANGLER 3.8L, 5.7L, & 6.1L IDLER PULLEY (NEW)	17112.07
1993-98 5.2L & 5.9L GRAND CHEROKEE TENSIONER WITH PULLEY	17112.50
1997-98 GRAND CHEROKEE 4.0L	17112.04
1997-04 4.0L GRAND CHEROKEE	17112.02
1999 4.0L GRAND CHEROKEE, TENSIONER WITH PULLEY	17112.51
2000-06 4.7L GRAND CHEROKEE, TENSIONER WITH PULLEY	17112.51
2002-06 3.7L GRAND CHEROKEE, TENSIONER WITH PULLEY	17112.51
2002-05 2.4L LIBERTY, TENSIONER W/ PULLEY	17112.52
2002-05 LIBERTY 2.4L	17112.05
2002-06 3.7L LIBERTY TENSIONER, W/ PULLEY	17112.51

4 COOLING FANS

DESCRIPTION	PART #
1991-95 4.0L WRANGLER (asymmetric style 5-blade)	17109.02
1997-99 CHEROKEE 2.5L (fan, motor & shroud assembly)	17102.52
1987-96 CHEROKEE 4.0L (fan, motor & shroud assembly)	17102.51
1997-01 CHEROKEE 4.0L (fan, motor & shroud assembly)	17102.52
1999-04 GRAND CHEROKEE 4.0L (fan, motor & shroud assembly)	17102.53
2004 GRAND CHEROKEE 3.7L (fan, motor & shroud assembly)	17102.53
1999-00 GRAND CHEROKEE 4.7L (fan, motor & shroud assembly)	17102.53
2005-07 GRAND CHEROKEE V6 & V8 (fan, motor & shroud assembly)	17102.54
2002-04 LIBERTY 2.4L 3.7L, (fan assembly)	17102.55
2006-07 COMMANDER (3.7L & 4.7L) (fan, motor & shroud assembly)	17102.54

THERMOSTATS & WATER PUMPS

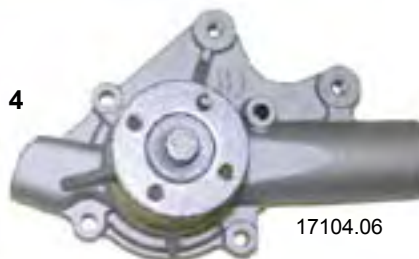
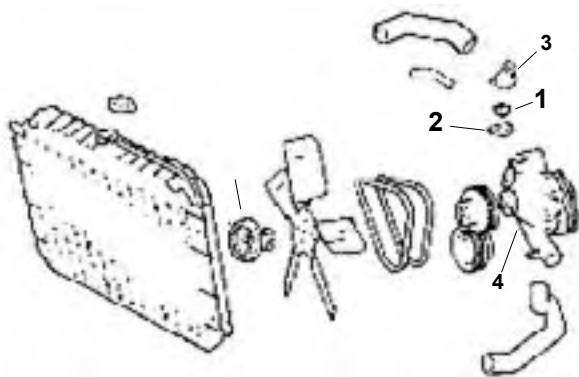

1 THERMOSTATS

DESCRIPTION	PART #
160°	17106.01
180°	17106.02
1997-06 WRANGLER, 195°	17106.03
1997-01 CHEROKEE, 195°	17106.03
1987-96 4 CYL CHEROKEE (European versions only)	17106.04
1993 GRAND CHEROKEE, 195°	17106.03
1993-98 V8 GRAND CHEROKEE, 195°	17106.03
1999-04 4.7L GRAND CHEROKEE	17106.05
2002-04 3.7L LIBERTY	17106.05

2 THERMOSTAT GASKETS

DESCRIPTION	PART #
1941-71 4 CYL L-HEAD 134	17117.01
1941-56 4 CYL L-HEAD 134, THERMOSTAT RETAINER	17107.01
1953-71 4 CYL F-HEAD 134	17117.02
1974-90 6 CYL ALL 258	17117.03
1974-91 8 CYL ALL	17117.04
1993-96 V8 5.2L GRAND CHEROKEE	17117.05

3 THERMOSTAT HOUSING W/O GASKET

DESCRIPTION	PART #
1953-71 4 CYL F-HEAD 134	17118.01
1972-86 8 CYL CJ	17118.05
1975-80 6 CYL 232, 258 4.2L	17118.04
1981-86 6 CYL 258 4.2L CJ	17118.02
1983-86 4 CYL 150 AMC CJ	17118.02
1987-90 6 CYL 4.0L WRANGLER	17118.02
1991-95 4 CYL 2.5L WRANGLER	17118.03
1992-95 6 CYL 4.0L WRANGLER	17118.03
1997-02 4 CYL 2.5L WRANGLER	17118.03
1987 4 CYL 150 AMC WRANGLER	17118.02
1983-87 4 CYL 150 AMC CHEROKEE	17118.02
1984-90 6 CYL 4.0L CHEROKEE	17118.02
1991-01 4 CYL CHEROKEE (not for export model)	17118.03
1992-01 6 CYL 4.0L CHEROKEE	17118.03
1993-98 6 CYL 4.0L GRAND CHEROKEE	17118.03
1999-04 6 CYL 4.0L GRAND CHEROKEE	17118.03
1972-93 8 CYL SJ	17118.05

4 WATER PUMPS

DESCRIPTION	PART #
MB & CJ :	
1941-71 4-134 MB & ALL CIVILIANS	17104.01
1941-71 4-CYL 134 WATER PUMP REPAIR KIT	17104.80
1941-71 4-CYL 134 WATER PUMP BEARING	17104.83
1948-63 6 CYL, 226 ENGINE WAGON & TRUCK	17104.09
1950-71 4-134 M38 OR M38A1 (double groove pulley)	17104.02
1965-71 V6 225 CJ	17104.10
1966-71 V6 225 CJ WATER PUMP GASKET (NEW)	17119.01
1971-74 6 CYL CJ	17104.11
1973-83 8 CYL ALL AMC-V8	17104.16
1975-79 6 CYL ALL	17104.12
1980-83 4 CYL GM 151 ALL	17104.03
1980-86 6 CYL ALL	17104.04
1980-86 6 CYL WITH SERPENTINE BELT	17104.05
1983-86 4 CYL CJ AMC 150	17104.04
1983-86 4 CYL CJ AMC 150 W/ SERPENTINE	17104.05
WRANGLER :	
1987-90 4 CYL WRANGLER W/O SERPENTINE	17104.07
1991-95 4 CYL WRANGLER	17104.07
1997-02 4 CYL WRANGLER	17104.07
2003-06 2.4L 4 CYL WRANGLER	17104.08
1987-90 6 CYL WRANGLER WITH SERPENTINE	17104.13
1987-90 6 CYL WRANGLER W/O SERPENTINE (EXPORT)	17104.06
1991-99 6 CYL WRANGLER WITH SERPENTINE	17104.07
2000-06 4.0L 6 CYL WRANGLER	17104.20
CHEROKEE :	
1983-86 4 CYL CHEROKEE AMC 150	17104.04
1987-90 4 CYL CHEROKEE WITHOUT SERPENTINE	17104.07
1987-01 6 CYL CHEROKEE	17104.14
1991-00 4 CYL CHEROKEE	17104.07
GRAND CHEROKEE & LIBERTY :	
1993-97 6 CYL GRAND CHEROKEE	17104.14
1993-98 V8 GRAND CHEROKEE	17104.17
1998 4.0L 6 CYL GRAND CHEROKEE W/ SERPENTINE	17104.07
1999-04 4.0L 6 CYL GRAND CHEROKEE	17104.20
1999-04 4.7L 6 CYL GRAND CHEROKEE	17104.19
1999-06 4.7L WATER PUMP GASKET	17119.03
2002-04 3.7L LIBERTY	17104.18
2002-06 3.7L WATER PUMP GASKET	17119.03
2002-06 2.4L 4 CYL LIBERTY	17104.08



1 HEATER HOSES

DESCRIPTION	PART #
WATER PUMP BYPASS HOSE ALL F HEAD	
134 ENGINES (CJ3B, CJ5, CJ6, M38, M38A1)	17116.02
1972-83 V8 CJ HEATER HOSE CLAMP (2 per vehicle)	17115.02
1972-83 V8 CJ, HEATER BYPASS HOSE	17116.01
1987-90 WRANGLER 4.2L, HEATER RETURN	17116.51
1987-90 WRANGLER 4.2L, HEATER SUPPLY	17116.56
1997-02 WRANGLER 2.5L, HEATER RETURN	17116.54
1997-99 WRANGLER 4.0L, HEATER RETURN	17116.55
1997-99 WRANGLER 4.0L, HEATER SUPPLY	17116.61
1988-90 CHEROKEE 4.0L, HEATER VALVE TO CORE	17116.63
1988-90 CHEROKEE 4.0L, HEATER VALVE TO TEE	17116.65
1988-90 CHEROKEE 4.0L, TEE TO PUMP	17116.62
1991-93 CHEROKEE 4.0L, HEATER CORE TO VALVE	17116.50
1991-93 CHEROKEE 4.0L, HEATER RETURN	17116.52
1991-93 CHEROKEE 4.0L, HEATER VALVE TO CORE	17116.64
1994-96 CHEROKEE 4.0L, HEATER SUPPLY	17116.58
1997-01 CHEROKEE 4.0L, HEATER RETURN	17116.53
1997-01 CHEROKEE 4.0L, HEATER SUPPLY	17116.59
1991-96 GRAND CHEROKEE 4.0L, HEATER SUPPLY	17116.57
1991-98 GRAND CHEROKEE V8, HEATER RETURN	17116.52
1997-98 GRAND CHEROKEE V8, HEATER SUPPLY	17116.60
1999-04 GRAND CHEROKEE 4.0L, HEATER SUPPLY	17116.61
1999-04 GRAND CHEROKEE 4.0L, HEATER RETURN	17116.55

2 LOWER RADIATOR HOSES

DESCRIPTION	PART #
1945-49 CJ2A	17114.01
1951-53 CJ3A	17114.02
1953-63 CJ3B	17114.02
1972-83 8 CYL CJ	17114.13
1975-86 6 CYL CJ	17114.08
1980-83 4 CYL CJ GM ENGINE	17114.03
1983-86 4 CYL CJ AMC	17114.04
1987-90 6 CYL 4.2L WRANGLER	17114.09
1987-95 4 CYL WRANGLER	17114.05
1991-95 6 CYL WRANGLER	17114.07
1997-00 6 CYL WRANGLER	17114.07
1997-02 4 CYL WRANGLER 2.5L	17114.06
2003-06 WRANGLER 2.4L	17114.19
2007-10 6 CYL WRANGLER 3.8L (NEW)	17114.25
1987-97 4 CYL CHEROKEE (with or without A/C)	17114.07
1987-01 6 CYL 4.0L CHEROKEE (with or without A/C)	17114.11
1997-01 6 CYL 4.0L CHEROKEE (NEW)	17114.23
1999-01 6 CYL 4.0L CHEROKEE RHD	17114.17
1993-98 6 CYL 4.0L GRAND CHEROKEE	17114.12
1993-98 8 CYL GRAND CHEROKEE	17114.14
1999-04 4.0L GRAND CHEROKEE	17114.15
1999-04 4.7L GRAND CHEROKEE	17114.16
2005-06 GRAND CHEROKEE 3.7L	17114.20
2005-09 GRAND CHEROKEE 4.7L	17114.21
2005-06 GRAND CHEROKEE 5.7L, 6.1L	17114.22
2002-05 LIBERTY 3.7L (NEW)	17114.24

3 UPPER RADIATOR HOSES

DESCRIPTION	PART #
1945-49 CJ2A	17113.01
1948-53 CJ3A	17113.02
1953-65 CJ3B	17113.03
1955-71 CJ5 4 CYL	17113.04
1980-83 4 CYL GM ENGINE CJ	17113.05
1983-86 4 CYL CJ AMC	17113.04
1948-64 6 CYL CJ 226	17113.10
1974-86 6 CYL CJ	17113.11
1974-81 V8 CJ	17113.18
1987-95 4 CYL WRANGLER	17113.07
1987-90 6 CYL WRANGLER	17113.12
1991-95 6 CYL WRANGLER	17113.13
2007-10 6 CYL WRANGLER (NEW)	17113.27
1997-06 6 CYL WRANGLER	17113.14
2003-06 4 CYL WRANGLER 2.4L	17113.23
1987-98 4 CYL CHEROKEE WITHOUT A/C	17113.08
1987-97 4 CYL CHEROKEE WITH A/C	17113.09
1987-98 6 CYL CHEROKEE WITHOUT A/C	17113.15
1987-93 6 CYL CHEROKEE WITH A/C	17113.15
1994-98 6 CYL CHEROKEE WITH A/C	17113.16
1999-01 6 CYL 4.0L CHEROKEE	17113.22
1993-98 6 CYL GRAND CHEROKEE	17113.17
1999-04 6 CYL 4.0L GRAND CHEROKEE	17113.21
2005-06 6 CYL GRAND CHEROKEE 3.7L	17113.24
1993-98 V8 GRAND CHEROKEE (both 5.2L & 5.9L)	17113.19
2005-06 V8 GRAND CHEROKEE 4.7L	17113.25
2002-05 LIBERTY 3.7L (NEW)	17113.26



17110.02



4 FAN BELTS (V-belts)

DESCRIPTION	PART #
1941-45 4 CYL 134 MB	17110.01
1945-49 4 CYL 134 CJ2A	17110.01
1948-53 4 CYL 134 CJ3A	17110.01
1950-52 4-134 M38 (pair)	17110.02
1952-71 4-134 M38A1 (pair)	17110.02
1953-65 4 CYL 134 CJ3B	17110.01
1955-72 4 CYL 134 CJ5	17110.01
1955-72 4 CYL 134 CJ6	17110.01
1976-86 CJ WITHOUT A/C	17110.03
1980-83 4 CYL GM 151	17110.05
1980-83 4 CYL GM 151 (power steering belt)	17110.06

5 SERPENTINE BELTS

DESCRIPTION	PART #
WRANGLER :	
1987-90 4.2L WRANGLER WITHOUT P/S WITH A/C	17111.27
1987-90 4.2L WRANGLER WITH P/S WITH A/C	17111.28
1991-93 2.5L & 4.0L WRANGLER WITH A/C & P/S	17111.24
1991-94 2.5L & 4.0L WRANGLER W/O A/C & W/ P/S LHD	17111.15
1991-94 WRANGLER (both 2.5L & 4.0L) W/ A/C & P/S	17111.06
1991-95 WRANGLER (2.5L & 4.0L) W/O A/C & W/O P/S	17111.08
1994-95 2.5L & 4.0L WRANGLER W/O A/C & W/ P/S RHD	17111.15
1995 2.5L & 4.0L WRANGLER LHD W/O A/C & W/ P/S	17111.12
1995 WRANGLER 2.5L & 4.0L W/ AC & W/ P/S;	17111.18
1997-02 2.5L WRANGLER W/O A/C & W/ P/S LHD	17111.12
1997-02 2.5L WRANGLER WITH AC	17111.09
1997-98 2.5L & 4.0L WRANGLER W/ A/C & W/ P/S LHD	17111.18
1997-99 4.0L WRANGLER W/O A/C & W/ P/S LHD	17111.12
1997-99 WRANGLER (2.5L & 4.0L) W/O A/C & W/O P/S	17111.11
2000-06 4.0L WRANGLER WITHOUT A/C	17111.21
2000-06 WRANGLER WITH A/C	17111.23
2003-06 2.4L WRANGLER W/ AIR CONDITIONING	17111.31
2007-10 3.8L WRANGLER W/ AIR CONDITIONING (NEW)	17111.38
2007-10 3.8L WRANGLER W/O A/C (NEW)	17111.39
CHEROKEE :	
1984-90 CHEROKEE 2.5L WITH A/C	17111.03
1987-90 CHEROKEE 2.5L WITHOUT A/C	17111.05
1987-90 CHEROKEE 4.0L	17111.04
1991-93 2.5 CHEROKEE WITHOUT A/C & WITHOUT P/S	17111.08
1991-95 2.5L CHEROKEE WITH A/C & P/S	17111.06
1991-95 2.5L CHEROKEE WITHOUT A/C & WITH P/S	17111.15
1991-95 4.0L CHEROKEE, LHD	17111.13
1991-95 4.0L CHEROKEE, RHD	17111.14
1996-00 2.5L RHD CHEROKEE WITHOUT A/C	17111.16
1996-00 2.5L CHEROKEE WITH A/C & WITH P/S LHD	17111.18
1996-00 2.5L CHEROKEE WITHOUT A/C	17111.12
1996-01 2.5L 4.0L CHEROKEE RHD (w/ 117 or 136 amp alt.)	17111.10
1996-01 4.0L CHEROKEE LHD	17111.17
1997-01 2.5L RHD CHEROKEE WITH A/C 17111.17	
GRAND CHEROKEE & LIBERTY :	
1993-95 4.0L GRAND CHEROKEE WITHOUT A/C	17111.15
1993-95 GRAND CHEROKEE 4.0L WITH A/C	17111.01
1993-95 GRAND CHEROKEE 5.2L	17111.07
1994 5.2L GRAND CHEROKEE	17111.26
1994-95 4.0L GRAND CHEROKEE WITH A/C	17111.25
1994-96 4.0L GRAND CHEROKEE WITHOUT A/C	17111.24
1996-98 4.0L GRAND CHEROKEE RHD (w/ 117 or 136 amp alt.)	17111.10
1996-98 4.0L GRAND CHEROKEE	17111.09
1996-98 GRAND CHEROKEE V8 (both 5.2L & 5.9L)	17111.19
1999-01 GRAND CHEROKEE 4.0L WITH A/C	17111.02
1999-03 V8 4.7 GRAND CHEROKEE	17111.22
1999-04 4.0L GRAND CHEROKEE	17111.23
2000-01 GRAND CHEROKEE W/ 3.1L V.M. DIESEL ENGINE (export markets)	17111.30
2004-06 GRAND CHEROKEE 4.7L, 05-06 WK 3.7L	17111.33
2005-06 GRAND CHEROKEE 3.7L	17111.33
2005-06 GRAND CHEROKEE 3.7L/4.7L ACCESSORY DRIVE	17111.34
2006 GRAND CHEROKEE 6.1L	17111.36
2002-06 2.4L LIBERTY W/ AIR CONDITIONING	17111.31

GAUGES



17206.01



17206.02



17206.04



17206.05



17209.02



17215.02



17215.01



17215.03



17210.01

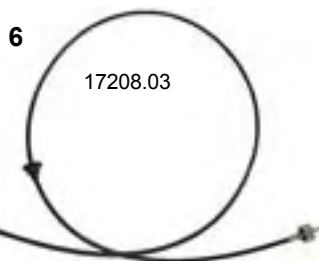

17208.03



17215.04



17210.02



17210.05



17210.06

1 SPEEDOMETER ASSEMBLIES (in miles)

DESCRIPTION	PART #
1942-43 MB WITH TRIPOMETER, w/ LONG NEEDLE	17206.02
1944-45 MB WITH TRIPOMETER, w/ SHORT NEEDLE	17206.03
1946-49 CJ2A	17206.01
1948-53 CJ3A	17206.01
1953-58 CJ3B (early style)	17206.01
1955-79 CJ3B (late style 0-90 mile dial)	17206.04
1955-79 CJ5 (0-90 mile dial)	17206.04
1955-75 CJ6 (0-90 mile dial)	17206.04
1980-83 CJ5 (5-85 mile dial)	17206.05
1980-86 CJ7 (5-85 mile dial)	17206.05
1980-86 CJ8 (5-85 mile dial)	17206.05

2 SPEEDOMETER ASSEMBLIES. (in kilometers)

DESCRIPTION	PART #
1959-65 CJ3B (late style)	17205.02
1955-79 CJ5	17205.02
1980-83 CJ5	17205.03
1955-75 CJ6	17205.02
1980-86 CJ7	17205.03
1980-86 CJ8	17205.03

3 SPEEDOMETER HEADS WITH ODOMETER (without case or other parts)

DESCRIPTION	PART #
1955-65 CJ3B (late style 0-90 mile dial)	17207.01
1955-65 CJ3B (late style kilometer dial for export markets)	17207.02
1955-79 CJ5 (0-90 mile dial)	17207.01
1955-79 CJ5 (kilometer dial for export markets)	17207.02
1980-83 CJ5 (5-85 mile dial)	17207.03
1980-83 CJ5 (kilometer dial for export markets)	17207.04
1955-75 CJ6 (0-90 mile dial)	17207.01
1955-75 CJ6 (kilometer dial for export markets)	17207.02
1980-86 CJ7 (5-85 mile dial)	17207.03
1980-86 CJ7 (kilometer dial for export markets)	17207.04
1980-86 CJ8 (5-85 mile dial)	17207.03
1980-86 CJ8 (kilometer dial for export markets)	17207.04

4 FUEL & TEMP GAUGES INSIDE SPEEDOMETER ASSY

DESCRIPTION	Stock No.
1980-86 CJ REPLACEMENT BI-TORQUE DESIGN FUEL & TEMP GAUGE PAIR (gauge pair must be used together)	17209.02

5 SPEEDOMETER GEARS

DESCRIPTION	PART #
1941-45 MB SPEEDOMETER ROUND GEAR (inside transfer case)	17211.01

6 SPEEDOMETER CABLES

DESCRIPTION	PART #
1941-45 MB 3 SPEED, 60"	17208.01
1945-49 CJ2A 3 SPEED, 60"	17208.01
1948-53 CJ3A 3 SPEED, 60"	17208.01
1953-65 CJ3B 3 SPEED, 60"	17208.01
1955-75 CJ5 3 SPEED, 60"	17208.01
1955-75 CJ6 3 SPEED, 60"	17208.01
1963-76 CJ, 4 SPEED, 67"	17208.02
1977-86 CJ, ALL W/ STANDARD TRANNY, 69"	17208.03
1976-79 CJ AUTOMATIC 80"	17208.04

7 TACHOMETERS

DESCRIPTION	PART #
1976-86 CJ TACHOMETER (all 4, 6 or 8 cylinders)	17215.02

8 CLOCKS

DESCRIPTION	PART #
1976-86 CJ CLOCK	17215.01

9 VOLTMETERS

DESCRIPTION	PART #
1976-86 CJ VOLTMETER	17215.03

10 AMMETERS

DESCRIPTION	PART #
1948-53 CJ3A, AMMETER	17210.01
1953-56 CJ3B, AMMETER	17210.01

11 OIL GAUGES

DESCRIPTION	PART #
1941-45 MB, OIL GAUGE	17210.02
1945-47 CJ2A, OIL GAUGE	17210.02
1948-49 CJ2A, OIL GAUGE	17210.03
1948-53 CJ3A, OIL GAUGE	17210.03
1953-56 CJ3B, OIL GAUGE	17210.03
1976-86 CJ OIL PRESSURE	17215.04

12 TEMPERATURE GAUGES

DESCRIPTION	PART #
1941-45 MB, TEMP GAUGE	17210.04
1945-47 EARLY CJ2A, TEMP GAUGE	17210.04
1948-49 CJ2A, TEMP GAUGE	17210.05
1948-53 CJ3A, TEMP GAUGE	17210.05
1953-56 CJ3B, TEMP GAUGE	17210.05

13 FUEL GAUGES

DESCRIPTION	PART #
1946-49 CJ2A, FUEL GAUGE (6V)	17210.06
1946-49 CJ2A, FUEL GAUGE (12V)	17210.07
1948-53 CJ3A, FUEL GAUGE (6V)	17210.06
1948-53 CJ3A, FUEL GAUGE (12V)	17210.07
1953-56 CJ3B, FUEL GAUGE (6V)	17210.06
1953-56 CJ3B, FUEL GAUGE (12V)	17210.07



1 TEMPERATURE SENSORS

DESCRIPTION	PART #
1991-96 4 CYLINDER 2.5L WRANGLER	17217.01
1988-90 6 CYLINDER 4.2L WRANGLER	17217.01
1991-97 6 CYLINDER 4.0L WRANGLER	17217.01
1991-96 4 CYLINDER 2.5L CHEROKEE	17217.01
1991-97 6 CYLINDER 4.0L CHEROKEE	17217.01
1993-98 V8 5.2L GRAND CHEROKEE	17217.02

2 TEMPERATURE SENDING UNITS

DESCRIPTION	PART #
1972-86 4, 6, OR 8 CYLINDER AMC CJ	17218.02
1972-86 4, 6, OR 8 CYLINDER AMC SJ	17218.02
1987-90 SJ (models with gauge)	17218.03
1987-90 WRANGLER (models with gauge)	17218.03
1991-95 WRANGLER (models with gauge)	17218.04
1994-95 WRANGLER (with warning lamp)	17218.05
1997-06 WRANGLER, TEMP SWITCH	17218.06
1987-90 CHEROKEE (models with gauge)	17218.03
1992-96 CHEROKEE (with warning lamp)	17218.05
1997-01 CHEROKEE, TEMP SWITCH	17218.06
1994-96 GRAND CHEROKEE (with warning lamp)	17218.05
1997-06 GRAND CHEROKEE, TEMP SWITCH	17218.06
2002-06 LIBERTY, TEMP SWITCH	17218.06

3 OIL PRESSURE SENDING UNITS

DESCRIPTION	PART #
1953-71 4 CYLINDER 134, CJ	17219.01
1975-86 4, 6 OR 8 CYLINDER AMC, CJ	17219.02
1975-86 6 OR 8 CYLINDER AMC, SJ	17219.02
1981 SJ & SOME CJ'S WITH 3 TERMINAL	17219.04
1981-83 CJ 4 CYLINDER 2.5L GM ENGINE	17219.03
1981-91 SJ (with 2 terminal)	17219.05
1987-91 WRANGLER (models w/ gauge)	17219.06
1987-93 WRANGLER (2 terminal, w/o gauge)	17219.05
1991-95 WRANGLER	17219.07
1997-99 2.5L/4.0L WRANGLER	17219.13
2000 WRANGLER	17219.12
2003-06 4.0L WRANGLER	17219.15
1984-90 CHEROKEE (models with gauge)	17219.06
1984-90 CHEROKEE DIESEL	17219.09
1984-91 CHEROKEE (models without gauges)	17219.08
1987-90 CHEROKEE (export models w/ 2 terminal)	17219.05
1991-96 CHEROKEE (European models only)	17219.10
1992-96 CHEROKEE	17219.11
1997-01 CHEROKEE	17219.12
1993-95 GRAND CHEROKEE	17219.07
1999-02 GRAND CHEROKEE	17219.12
2003-06 4.0L GRAND CHEROKEE	17219.15
2002 2.4L/3.7L LIBERTY	17219.12
2003-06 3.7L LIBERTY	17219.15
2005-06 2.8L LIBERTY	17219.12

4 MAP SENSORS

DESCRIPTION	PART #
1987-96 2.5L WRANGLER	17223.01
1987-96 4.0L WRANGLER	17223.01
1987 4.2L WRANGLER	17223.01
1997-04 4.0L WRANGLER	17223.02
1997-02 2.5L WRANGLER	17223.02
1987-96 2.5L CHEROKEE	17223.01
1987-96 4.0L CHEROKEE	17223.01
1987 4.2L CHEROKEE	17223.01
1997-01 CHEROKEE	17223.02
1999-03 4.0L GRAND CHEROKEE	17223.02
1993-96 5.2L GRAND CHEROKEE	17223.03

5 INTAKE TEMPERATURE SENSORS

DESCRIPTION	PART #
1988-96 4 & 6 CYLINDER WRANGLER	17221.01
2003-04 2.4L 4 CYLINDER WRANGLER	17221.03
1997-06 4.0L 6 CYLINDER WRANGLER	17221.02
1988-96 4 & 6 CYLINDER CHEROKEE	17221.01
1999-04 4.0L 6 CYLINDER GRAND CHEROKEE	17221.02
2001-04 V8 4.7L GRAND CHEROKEE	17221.03
2003-04 3.7L 6 CYLINDER LIBERTY	17221.03

6 CAMSHAFT POSITION SENSORS

DESCRIPTION	PART #
2004-06 WRANGLER 2.4L	17257.03
2001-04 GRAND CHEROKEE 4.7L	17257.02
2004-06 GRAND CHEROKEE 4.7L	17257.04
2005-06 GRAND CHEROKEE 5.7L	17257.04
2005-06 GRAND CHEROKEE 3.7L	17257.04
2002-03 LIBERTY 3.7L	17257.02
2002-05 LIBERTY 2.4L	17257.03
2000-01 CHEROKEE 4.0L (NEW)	17257.01
2004 GRAND CHEROKEE 4.0L (NEW)	17257.01
2004-06 LIBERTY 3.7L	17257.04

7 CRANKSHAFT POSITION SENSORS

DESCRIPTION	PART #
1991-92 2.5L/4.0L WRANGLER	17220.03
1993-95 4.0L WRANGLER	17220.07
1997-98 4.0L WRANGLER	17220.05
1997-02 2.5L & 1997-2005 4.0L WRANGLER	17220.13
2003-06 4.0L WRANGLER	17220.04
1991-95 4.0L CHEROKEE	17220.02
1997-01 4.0L CHEROKEE	17220.12
1997-01 4.0L CHEROKEE	17220.15
1994-96 5.2L V8 GRAND CHEROKEE	17220.01
1994-96 5.2L GRAND CHEROKEE	17220.01
1997-98 4.0L GRAND CHEROKEE	17220.05
1997-98 5.2L & 5.9L GRAND CHEROKEE	17220.14
1999-04 4.0L GRAND CHEROKEE	17220.05
1999-06 4.7L GRAND CHEROKEE	17220.08
2002-03 3.7L LIBERTY	17220.09
2002-04 2.4L LIBERTY	17220.10
2004 2.4L LIBERTY	17220.06
2004-06 3.7L LIBERTY	17220.11

8 AMBIENT TEMPERATURE SENSORS

DESCRIPTION	PART #
1999-04 GRAND CHEROKEE (NEW)	17237.08
2005-07 GRAND CHEROKEE (NEW)	17237.08

SENSORS



1 THROTTLE POSITION SENSORS

DESCRIPTION	PART #
1986-90 4 CYLINDER 2.5L WRANGLER	17224.01
1991-96 4 CYLINDER 2.5L WRANGLER	17224.02
1991-96 6 CYLINDER 4.0L WRANGLER	17224.02
1997-01 2.5L & 4.0L WRANGLER	17224.04
2002-04 4.0L WRANGLER	17224.06
2003-04 2.4L WRANGLER	17224.06
1986-90 4 CYLINDER 2.5L CHEROKEE	17224.01
1991-96 4 CYLINDER 2.5L CHEROKEE	17224.02
1991-96 6 CYLINDER 4.0L CHEROKEE	17224.02
1993-96 6 CYLINDER 4.0L GRAND CHEROKEE	17224.02
1993-96 8 CYLINDER 5.2L GRAND CHEROKEE	17224.02
1997-98 8 CYLINDER 5.2L GRAND CHEROKEE	17224.03
1999 4.7L GRAND CHEROKEE	17224.05
2003 4.0L GRAND CHEROKEE	17224.06
2002-04 2.4L LIBERTY	17224.06

2 ABS SPEED SENSORS

DESCRIPTION	PART #
1997-06 WRANGLER, FRONT (NEW)	17259.01
1997-06 WRANGLER, LH REAR (NEW)	17259.03
1997-06 WRANGLER, RH REAR (NEW)	17259.02
1999-04 GRAND CHEROKEE, LH REAR	17259.05
1999-04 GRAND CHEROKEE, RH REAR	17259.04

3 WASHER FLUID LEVEL SENSOR

DESCRIPTION	PART #
2002-05 LIBERTY	17237.12
2002-05 GRAND CHEROKEE	17237.12

4 KNOCK SENSORS

DESCRIPTION	PART #
1991-06 6 CYLINDER 4.0L WRANGLER (NEW)	17223.50
1991-97 6 CYLINDER 4.0L CHEROKEE (NEW)	17223.50
1993-98 6 CYLINDER 4.0L GRAND CHEROKEE (NEW)	17223.50
2003-07 V8 4.7L GRAND CHEROKEE	17223.51
2005-07 V8 5.7L GRAND CHEROKEE (NEW)	17223.52
2005-06 V6 3.7L LIBERTY (NEW)	17223.52

5 OXYGEN SENSORS

DESCRIPTION	PART #
CJ :	
1981-82 4 CYLINDER CJ	17222.01
1981-85 4 CYLINDER 2.5L CJ	17222.02
1983-86 6 CYLINDER 4.2L CJ	17222.02
WRANGLER :	
1991-96 4 CYLINDER 2.5L WRANGLER	17222.04
1997-99 4 CYLINDER 2.5L WRANGLER (after cat)	17222.06
1997-99 4 CYL 2.5L WRANGLER (before cat)	17222.07
2000 4 CYL 2.5L WRANGLER (after cat)	17222.14
2000 4 CYL 2.5L WRANGLER (after cat)	17222.14
2001-02 4 CYL 2.5L WRANGLER (before cat)	17222.23
2003-04 4 CYL 2.4L WRANGLER (after cat)	17222.18
2003-04 4 CYL 2.4L WRANGLER (before cat)	17222.23
2005-06 4 CYL 2.4L WRANGLER (before or after cat)	17222.28
1987-90 6 CYLINDER 4.2L WRANGLER	17222.08
1991-95 6 CYLINDER 4.0L WRANGLER	17222.09
1997-99 6 CYLINDER 4.0L WRANGLER (after cat)	17222.05
2000 6 CYL 4.0L WRANGLER (after cat)	17222.15
2001-03 6 CYLINDER 4.0L WRANGLER (rear before cat)	17222.23
2004 6 CYL 4.0L WRANGLER (front after cat)	17222.31
2004 6 CYL 4.0L WRANGLER (rear after cat)	17222.36
2005-06 6 CYLINDER 4.0L WRANGLER (front after cat)	17222.28
(rear before cat)	17222.39
(rear after cat)	17222.37
CHEROKEE :	
1983-85 4 CYLINDER 2.5L CHEROKEE	17222.02
1986-90 4 CYLINDER 2.5L CHEROKEE	17222.03
1991-96 4 CYLINDER 2.5L CHEROKEE	17222.04
1996-00 4 CYLINDER 2.5L CHEROKEE (after cat)	17222.05
1997-99 4 CYL 2.5L CHEROKEE (before cat)	17222.07
1984-86 6 CYLINDER CHEROKEE 2.8L V6	17222.08
1987-90 6 CYLINDER 4.0L CHEROKEE	17222.16
1991-95 6 CYLINDER 4.0L CHEROKEE	17222.09
1996-00 6 CYLINDER 4.0L CHEROKEE (after cat)	17222.05
1996-97 6 CYL 4.0L CHEROKEE (before cat)	17222.11
1997-98 6 CYLINDER 4.0L CHEROKEE (after cat)	17222.05
GRAND CHEROKEE :	
1993-95 6 CYLINDER 4.0L GRAND CHEROKEE	17222.10
1996-98 6 CYL 4.0L GRAND CHEROKEE (after cat)	17222.05
1997-98 6 CYL 4.0L GRAND CHEROKEE (before cat)	17222.12
1999-00 6 CYL 4.0L GRAND CHEROKEE (before cat)	17222.22
2002-03 6 CYL 4.0L GRAND CHEROKEE (front after cat)	17222.17
2004 6 CYLINDER 4.0L GRAND CHEROKEE (front after cat)	17222.32
(rear after cat)	17222.36
1993-96 V8 5.2L GRAND CHEROKEE (before cat)	17222.09
1997-98 V8 5.2L GRAND CHEROKEE (after cat)	17222.05
1997-98 V8 GRAND CHEROKEE (before cat)	17222.07
1999-00 V8 4.7L GRAND CHEROKEE (before cat)	17222.22
2001 V8 4.7L GRAND CHEROKEE (after cat RH)	17222.24
2001-03 V8 4.7L GRAND CHEROKEE (before cat LH)	17222.24
(before cat RH)	17222.26
(after cat RH) (NEW)	17222.20
2002-03 V8 4.7L GRAND CHEROKEE (after cat LH)	17222.19
2004 V8 4.7L GRAND CHEROKEE (front after cat)	17222.32
(rear after cat)	17222.36
2005-06 V8 4.7L GRAND CHEROKEE (before or after cat)	17222.29
2005-06 V8 4.7L/5.7L GRAND CHEROKEE (after cat)	17222.28
LIBERTY :	
2002-03 4 CYL 2.4L LIBERTY (after cat)	17222.18
2004 4 CYL 2.4L LIBERTY (rear after cat)	17222.37
2004 4 CYL 2.4L LIBERTY (before cat)	17222.28
2002-03 6 CYLINDER 3.7L LIBERTY (after cat LH)	17222.18
(after cat RH)	17222.17
2002-03 6 CYL 3.7L LIBERTY (before cat LH)	17222.25
2005 6 CYL 3.7L LIBERTY (after cat LH)	17222.28
2006 6 CYLINDER 3.7L LIBERTY (after cat)	17222.28

ALTERNATORS & STARTERS



17225.01



17226.01



17231.02



17227.03



17228.01



17228.04

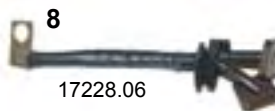

17228.06



17230.05



17229.03



1 ALTERNATORS

DESCRIPTION	PART #
1975-79 CJ 63 AMP (uses standard hardware)	17225.01
1975-79 SJ 63 AMP (uses standard hardware)	17225.01
1980-86 CJ 63 AMP (uses metric hardware)	17225.02
1980-86 SJ 63 AMP (uses metric hardware)	17225.02
1981-86 CJ 56-78 AMP (tagged 1105081 OR 1105082)	17225.03
1981-86 SJ 56-78 AMP (tagged 1105081 OR 1105082)	17225.03
1987-90 4 CYLINDER WRANGLER 61-74 AMP tagged 1101171 OR 1101172	17225.04
tagged 1101175 OR 1101176	17225.05
1991-99 4 CYLINDER 2.5L WRANGLER, 90 AMP	17225.06
1999-00 4 CYLINDER 2.5L WRANGLER, 117 AMP	17225.13
1991-99 6 CYLINDER 4.0L WRANGLER, 90 AMP	17225.06
1999 6 CYLINDER 4.0L WRANGLER 117, AMP	17225.13
1987-90 4 CYLINDER CHEROKEE 61-74 AMP tagged 1101171 OR 1101172	17225.04
tagged 1101175 OR 1101176	17225.05
1991-99 4 CYLINDER 2.5L CHEROKEE, 90 AMP	17225.06
1999 4 CYLINDER 2.5L CHEROKEE, 117 AMP	17225.13
1987-90 6 CYLINDER 4.0L CHEROKEE 85-100 AMP (tagged 1101167 OR 1101170)	17225.07
1987-90 6 CYLINDER 4.0L CHEROKEE 60 AMP (tagged 1101168)	17225.08
1991-98 6 CYLINDER 4.0L CHEROKEE, 90 AMP	17225.06
1999-00 6 CYLINDER 4.0L CHEROKEE 117, AMP	17225.13
2001 6 CYLINDER 4.0L CHEROKEE, 117 AMP	17225.14
1993-94 V8 GRAND CHEROKEE	17225.09
1995-98 V8 GRAND CHEROKEE, 130 AMP (NEW)	17225.16
1999-00 V8 4.7L GRAND CHEROKEE	17225.11
1993-98 6 CYLINDER 4.0L GRAND CHEROKEE, 90 AMP	17225.06
1999-04 6 CYLINDER 4.0L GRAND CHEROKEE	17225.10
2001-03 V8 4.7L GRAND CHEROKEE, 136 AMP (NEW)	17225.15
2002-05 4 CYLINDER 2.4L LIBERTY, 136 AMP (NEW)	17225.17
2003-07 V6 3.7L LIBERTY, 136 AMP (NEW)	17225.15

2 ALTERNATOR COMPONENTS

DESCRIPTION	PART #
1976-90 CJ, SJ REGULATOR, ELECTRONIC	17226.01
1976-86 CJ, SJ RECTIFIER	17226.02
1976-86 CJ, SJ TRIO DIODE	17226.03
1976-86 CJ, SJ NEEDLE BEARING	17226.04
1976-86 CJ, SJ FRONT BEARING	17226.05

3 VOLTAGE REGULATORS

DESCRIPTION	PART #
1941-45 MB, 6V	17231.06
1946-63 CJ, 6V	17231.02
1946-71 CJ2A, 12V	17231.03
1946-71 CJ3A, 12V	17231.03
1946-71 CJ3B, 12V	17231.03
1946-71 CJ5, 12V	17231.03
1946-71 CJ6, 12V	17231.03
1976-86 CJ, ELECTRONIC	17226.01
1976-90 SJ, ELECTRONIC	17226.01

4 STARTERS

DESCRIPTION	PART #
1972-86 6 OR 8 CYL CJ OR SJ	17227.03
1988-91 V8 SJ	17227.06
1987-93 4 CYL 2.5L WRANGLER W/ FUEL INJECTION	17227.04
1988-00 6 CYL 4.2L OR 4.0L WRANGLER	17227.06
1994-00 4 CYL 2.5L WRANGLER W/ FUEL INJECTION	17227.05
1999-02 2.5L WRANGLER W/ AUTO TRANSMISSION	17227.09
1999-02 2.5L WRANGLER W/ MANUAL TRANSMISSION	17227.10
2004-06 4.0L WRANGLER W/ MANUAL TRANS	17227.13
1987-93 4 CYL 2.5L CHEROKEE W/ FUEL INJECTION	17227.04
1987-98 6 CYL 4.0L CHEROKEE	17227.06
1993-98 V8 GRAND CHEROKEE	17227.07
1994-00 4 CYL 2.5L CHEROKEE W/ FUEL INJECTION	17227.05
1999-00 GRAND CHEROKEE	17227.08
1999-00 CHEROKEE	17227.08
1999-01 4.0L CHEROKEE	17227.08
1993-98 6 CYL 4.0L GRAND CHEROKEE	17227.06
1999-02 4.0L GRAND CHEROKEE	17227.08
2003-04 6 CYL 4.0L GRAND CHEROKEE	17227.13
2003-06 4.0L WRANGLER W/ AUTO TRANS (NEW)	17227.16
2004 V8 4.7L GRAND CHEROKEE	17227.14

5 STARTER COMPONENTS

DESCRIPTION	PART #
1972-86 6 OR 8 CYL CJ, ARMATURE	17228.01
1972-86 6 OR 8 CYL SJ, ARMATURE	17228.01
1978-86 6 OR 8 CYL CJ, POINT SET	17228.02
1978-86 6 OR 8 CYL SJ, POINT SET	17228.02
1976-86 6 OR 8 CYL, CJ, COIL FIELD	17228.03
1976-86 6 OR 8 CYL, SJ, COIL FIELD	17228.03

6 STARTER END HOUSINGS

DESCRIPTION	PART #
1972-77 6 OR 8 CYL CJ	17228.04
1972-77 6 OR 8 CYL SJ	17228.04
1978-86 6 OR 8 CYL CJ	17228.05
1978-86 6 OR 8 CYL SJ	17228.05

7 STARTER DRIVES

DESCRIPTION	PART #
1955-63 CJ 6V	17229.01
1964-71 CJ 12V	17229.02
1972-86 6 OR 8 CYL CJ	17229.03
1972-86 6 OR 8 CYL SJ	17229.03
1987-00 6 CYL 4.0L CHEROKEE	17229.04
1988-00 6 CYL 4.2L OR 4.0L WRANGLER	17229.04
1993-98 6 CYL 4.0L GRAND CHEROKEE	17229.04

8 STARTER BRUSH SETS

DESCRIPTION	PART #
1988-00 6 CYL 4.2L OR 4.0L WRANGLER	17228.06
1988-00 6 CYL 4.0L CHEROKEE	17228.06
1993-98 6 CYL 4.0L GRAND CHEROKEE	17228.06
BRUSH HOLDER	17228.07

9 SOLENOIDS

DESCRIPTION	PART #
1955-71 CJ 12V, 3 TERMINAL	17230.01
1972-79 CJ 6 OR 8 AUTO OR MANUAL	17230.02
1980-86 CJ 6 OR 8 CYL WITH AUTOMATIC	17230.04
1980-87 CJ 6 OR 8 CYL WITH MANUAL TRANS	17230.03
1983-86 CJ	17230.05
1984-86 CJ 4 CYL WITH MANUAL TRANS	17230.03
1980-87 WRANGLER 6 CYL WITH MANUAL TRANS	17230.03
1987 WRANGLER 4 CYL WITH AUTOMATIC TRANS	17230.05
1987 WRANGLER 4 CYL WITH MANUAL TRANS	17230.03
1987-90 WRANGLER	17230.06
1980-87 CHEROKEE 6 CYL WITH MANUAL TRANS	17230.03
1983-87 CHEROKEE	17230.05
1984-87 CHEROKEE 4 CYL WITH MANUAL TRANS	17230.03
1987-99 ALL 4.0L, 4.2L, 5.9L, MITSUBISHI TYPE, ON STARTER (NEW)	17230.07
1987-90 CHEROKEE	17230.06
1987-93 CHEROKEE (diesel models)	17230.06

10 EXACT FIT WIRING HARNESS FOR 1946-65 CJ:

DESCRIPTION	PART #
1945-EARLY 46 EARLY CJ2A (horn on firewall)	
CLOTH WIRE	17201.01
SAME AS ABOVE BUT INCLUDES TURN SIGNAL WIRES	17201.02*
1946-LATE-1949 CJ2A, (horn on fender), CLOTH WIRING	17201.03
SAME AS ABOVE BUT INCLUDES TURN SIGNAL WIRES	17201.04*
1949-1953 CJ3A, CLOTH WIRING	17201.05
SAME AS ABOVE BUT INCLUDES TURN SIGNAL WIRES	17201.06
1952-56 CJ3B W/ SMALL SPEEDOMETER, CLOTH WIRING	17201.07*
1957-64 CJ3B WITH LARGE SPEEDOMETER, PLASTIC WIRING	17201.08*
1954-56 CJ5, CLOTH WIRING	17201.09*
1957-65 CJ5, PLASTIC WIRING	17201.10*

* THESE KITS INCLUDE TURN SIGNAL WIRES

SWITCHES



1 TURN SIGNAL SWITCHES & COMPONENTS

DESCRIPTION	PART #
1946-67 C/J'S (universal type)	17232.01
1976-86 CJ TURN SIGNAL SWITCH LEVER	13318.07
1977-86 CJ	17232.02
1981-86 CJ TURN SIGNAL CAM	17232.04
1987-93 WRANGLER	17232.02
1987-95 WRANGLER TURN SIGNAL CAM	17232.04
1994-95 WRANGLER	17232.05
1984-93 CHEROKEE	17232.02
1994 CHEROKEE	17232.05

2 DIMMER SWITCHES

DESCRIPTION	PART #
1946-71 ALL CJ	17233.01
1972-86 ALL CJ	17233.02
1987-89 WRANGLER	17233.03
1990-95 WRANGLER	17233.04
1984-88 CHEROKEE	17233.03
1991-96 CHEROKEE	17233.04

3 HEADLIGHT SWITCHES

DESCRIPTION	PART #
1946-71 CJ	17234.01
1968-86 CJ H/L, WIPER, HEATER SWITCH NUT	17234.11
1968-86 CJ H/L, WIPER, HEATER SWITCH SPACER	17234.12
1973-79 CJ	17234.03
1979-86 CJ	17234.04
1981-86 CJ	17234.07
1973-79 SJ	17234.03
1981-85 SJ	17234.04
1987-95 WRANGLER	17234.05
1997-99 WRANGLER	17234.06
1984-91 CHEROKEE	17234.08
1992-96 CHEROKEE	17234.09
1997-00 CHEROKEE	17234.06
1987-91 GRAND CHEROKEE	17234.07

4 MULTIFUNCTION SWITCHES

DESCRIPTION	PART #
1997-00 WRANGLER	17234.16
2001-04 WRANGLER WITHOUT FOG LAMP	17234.17
2001-04 WRANGLER WITHOUT FACTORY LOG LAMPS	17234.19
1993-98 GRAND CHEROKEE	17234.10
1999 GRAND CHEROKEE W/O AUTO HEADLIGHTS	17234.18
2001-04 GRAND CHEROKEE WITHOUT FOG LAMPS WITHOUT AUTO HEADLIGHTS	17234.20
2002-06 LIBERTY WITHOUT FOG LAMP	17234.14
2004-05 LIBERTY WITH FOG LAMP	17234.15

5 HEADLIGHT KNOBS

DESCRIPTION	PART #
1946-71 CJ HEADLIGHT KNOB, BLACK, (MARKED "LIGHT")	17234.02
1973-86 CJ HEADLIGHT	13318.06
1968-86 CJ WIPER & FAN MOTOR (2 needed)	13318.05

6 BRAKE LIGHT SWITCHES

DESCRIPTION	PART #
1941-45 MB	17238.01
1945-59 CJ	17238.01
1960-72 CJ	17238.02
1981-86 CJ (models w/o cruise)	17238.06
1976-92 SJ CHEROKEE (models w/o cruise)	17238.06
1984-90 WRANGLER (models w/ cruise)	17238.03
1987-90 WRANGLER (models w/o cruise)	17238.06
1991-95 WRANGLER	17238.07
1997-06 WRANGLER, 1997-04 WRANGLER (TJ), 1997-01 CHEROKEE (XJ), 1993-98 GRAND CHEROKEE (ZJ), 1999-04 GRAND CHEROKEE (WJ)	17238.04
1984-90 CHEROKEE (models w/ cruise)	17238.03
1984-90 CHEROKEE (models w/o cruise)	17238.06
2002 LIBERTY	17238.08
2003-06 LIBERTY	17238.05

7 FLASHERS

DESCRIPTION	PART #
1974-95 CJ FLASHER 2 BLADE (#552)	12411.01
1976-95 CJ FLASHER (#224)	12411.02
1974-95 WRANGLER FLASHER 2 BLADE (#552)	12411.01
1976-95 WRANGLER FLASHER (#224)	12411.02
1987-95 WRANGLER FLASHER W/ 3 BLADE (#550)	12411.03
1987-95 CHEROKEE FLASHER W/ 3 BLADE (#550)	12411.03

8 WIPER SWITCHES

DESCRIPTION	PART #
1987-95 WRANGLER (w/o intermittent & w/o tilt)	17236.01
1987-95 WRANGLER (with tilt column)	17236.04
1997-99 WRANGLER (w/o intermittent)	17236.07
1997-00 WRANGLER (with intermittent) (NEW)	17236.06
1997-06 WRANGLER, REAR	17236.05
1984-93 CHEROKEE (w/o intermittent & w/o tilt)	17236.01
1984-93 CHEROKEE (w/o intermittent & w/ tilt)	17236.03

9 MISC. SWITCHES & RELAYS

DESCRIPTION	PART #
1997-00 WRANGLER, FOG LAMP SWITCH (NEW)	17234.21
2001 CHEROKEE, FOG LAMP SWITCH (NEW)	17234.21
1987-92 WRANGLER, RELAY FOR FOG LAMP, HEADLIGHT, REAR WIPER & POWER LOCK	17237.02
1993-04 WRANGLER, RELAY FOR STARTER, HORN, ABS, AC, FOG LIGHTS, FUEL PUMP	17237.07
1994-01 CHEROKEE, DOOR AJAR SWITCH	17237.01
1987-92 CHEROKEE, RELAY FOR FOG LAMP, HEADLIGHT, REAR WIPER & POWER LOCK	17237.02
1999-04 GRAND CHEROKEE, RELAY FOR STARTER, HORN, ABS, AC, FOG LIGHTS, FUEL PUMP	17237.07
1999-06 GRAND CHEROKEE, GLOVE BOX LIGHT SWITCH	17237.03
1992-95 WRANGLER, REAR DEFROST SWITCH (NEW)	17237.05
1999-04 GRAND CHEROKEE TEMP. SENSOR (NEW)	17237.08
2005-07 GRAND CHEROKEE TEMP. SENSOR (NEW)	17237.08



NEW AND IMPROVED!

1

17239.01

For restoration purposes this distributor has been crafted to look like the original, but on the inside it's a whole new story. The troublesome points have been replaced with a state of the art electromagnetic pickup and a built-in electronic control module. With the hookup of the two simple wires (installation instructions included), this distributor will improve the performance and driveability of any 12-volt 134-engine. No more fooling around in trying to get the points adjusted to the correct setting. Just drop in, plug in and go. (Will not work with 6-volt models and is not original for M38 or M38A1). For replacement parts specifically for this distributor, order module #17252.05, cap #17244.02, and rotor 17246.02.

2

17240.01

3

17244.07

4

17241.01

5

17242.01

6

17243.04

7

17246.14

1 NEW DISTRIBUTORS

DESCRIPTION	PART #
1941-71 4 CYL 134 ENGINE	17239.01
1947-63 6 CYL CJ & TRUCK 12V 226CI (NEW)	17239.08
1978-90 6 CYL 4.2L (without cap or rotor)	17239.02
1978-90 6 CYL 4.2L (with cap or rotor)	17239.03
1991-93 6 CYL 4.0L WRANGLER	17239.04
1994-97 4.0L 6 CYL WRANGLER	17239.05
1991-93 6 CYL 4.0L CHEROKEE	17239.04
1994-97 4.0L 6 CYL CHEROKEE	17239.05
1994-97 4.0L 6 CYL GRAND CHEROKEE	17239.05
1978-91 V8 AMC DISTRIBUTOR ASSEMBLY	17239.06

2 REMANUFACTURED DISTRIBUTORS: (w/ cap & rotor)

DESCRIPTION	PART #
1972-74 6 CYL CJ	17240.01
1972-74 6 CYL SJ	17240.01
1975-77 6 CYL PRESTOLITE, CJ	17240.02
1975-77 6 CYL PRESTOLITE, SJ	17240.02

3 DISTRIBUTOR CAPS

DESCRIPTION	PART #
1941-45 4 CYL 134 MB, 6V	17244.01
950-52 M38 4 CYL, 24V	17244.03
1953-68 M38A1 4 CYL, 24V	17244.03
1945-62 4 CYL 134 CJ, 6V	17244.01
11960-71 CJ 4 CYL 134, 12V	17244.02
1972-74 6 CYL CJ WITH POINT IGNITION, ALL	17244.07
1972-74 V8 CJ WITH POINT IGNITION	17244.13
1975-77 6 CYL CJ WITH PRESTOLITE IGNITION, ALL	17244.08
1975-77 V8 CJ WITH PRESTOLITE, ALL	17244.14
1978-86 6 CYL 4.2L CJ	17244.09
1978-92 V8 CJ WITH MOTORCRAFT, ALL	17244.15
1983-96 4 CYL AMC 150 CJ	17244.04
1948-65 226 OR 230 6 CYL ENGINES	17244.06
1972-74 6 CYL SJ WITH POINT IGNITION, ALL	17244.07
1972-74 V8 SJ WITH POINT IGNITION	17244.13
1975-77 6 CYL SJ WITH PRESTOLITE IGNITION, ALL	17244.08
1975-77 V8 SJ WITH PRESTOLITE, ALL	17244.14
1978-90 6 CYL 4.2L SJ	17244.09
1978-92 V8 SJ WITH MOTORCRAFT, ALL	17244.15
1987-90 4 CYL AMC 150 WRANGLER	17244.04
1987-90 6 CYL 4.2L WRANGLER	17244.09
1987-93 6 CYL 4.0L WRANGLER	17244.10
1991-95 4 CYL WRANGLER	17244.05
1994-00 6 CYL 4.0L WRANGLER	17244.11
1997-02 2.5L 4 CYL WRANGLER	17244.05
1984-90 4 CYL AMC 150 CHEROKEE	17244.04
1987-93 6 CYL 4.0L CHEROKEE	17244.10
1991-01 4 CYL CHEROKEE	17244.05
1993-98 V8 GRAND CHEROKEE	17244.16
1994-00 6 CYL 4.0L CHEROKEE	17244.11
1994-98 6 CYL 4.0L GRAND CHEROKEE	17244.11

4 DISTRIBUTOR SENSORS

DESCRIPTION	PART #
1978-91 V8 AMC ENGINE, DISTRIBUTOR SENSOR	17241.01
1987-90 2.5L CHEROKEE WITH CARB. DISTRIBUTOR SENSOR	17241.02
1987-90 2.5L WRANGLER WITH CARB. DISTRIBUTOR SENSOR	17241.02

5 DISTRIBUTOR CONDENSORS

DESCRIPTION	PART #
1941-71 ALL CJ	17242.01
1972-74 V8	17242.02
1966-71 225 V6	17242.02
1972-74 6 CYL	17242.03

6 DISTRIBUTOR POINT SETS

DESCRIPTION	PART #
1941-45 MB 4-CYL 134	17243.01
1945-71 CJ 4-CYL 134	17243.01
1948-66 6 CYL-226, 6 CYL-230	17243.02
1965-74 6 CYL 232, 258 ALL	17243.03
1965-71 CJ V6	17243.04
1965-74 V8 ALL	17243.04

7 DISTRIBUTOR ROTORS

DESCRIPTION	PART #
1941-45 4-134 MB	17246.01
1945-62 4-134 CJ	17246.01
1960-71 4-134 CJ, 12V	17246.02
1972-74 6 CYL CJ, ALL POINT IGNITION	17246.07
1975-77 6 CYL CJ, ALL PRESTOLITE IGNITION	17246.08
1975-77 V8 CJ, PRESTOLITE IGNITION	17246.13
1978-86 6 CYL ALL 4.2L CJ	17246.09
1978-92 V8 CJ WITH MOTORCRAFT, ALL	17246.14
1983-86 4 CYL AMC 150 CJ WITH CARB. & EFI	17246.04
1972-74 6 CYL SJ, ALL POINT IGNITION	17246.07
1975-77 6 CYL SJ, ALL PRESTOLITE IGNITION	17246.08
1975-77 V8 SJ, PRESTOLITE IGNITION	17246.13
1978-92 V8 SJ WITH MOTORCRAFT, ALL	17246.14
1987-90 4 CYL AMC 150 WRANGLER W/ CARB. & EFI	17246.04
1987-90 6 CYL ALL 4.2L WRANGLER	17246.09
1987-93 6 CYL ALL 4.0L WRANGLER	17246.05
1994-95 6 CYL WRANGLER	17246.06
1997-02 4 CYL WRANGLER	17246.06
1984-90 4 CYL AMC 150 CHEROKEE W/ CARB. & EFI	17246.04
1984-86 6 CYL V6 CHEROKEE	17244.12
1987-93 6 CYL ALL 4.0L CHEROKEE	17246.05
1991-93 4 CYL CHEROKEE W/ MULTI-PORT FUEL INJ.	17246.05
1994-96 6 CYL CHEROKEE	17246.06
1997-01 4 CYL CHEROKEE	17246.06
1993-98 V8 GRAND CHEROKEE	17246.15

8 DISTRIBUTOR SWITCH PLATES

DESCRIPTION	PART #
1991-95 WRANGLER 2.5L/4.0L	17241.03
1998-02 WRANGLER 2.5L/4.0L (NEW)	17241.05
1991-97 CHEROKEE 2.5L/4.0L	17241.03
1993-97 GRAND CHEROKEE 2.5L/4.0L	17241.03
1993-97 GRAND CHEROKEE 5.2L	17241.04

IGNITION



1 17245.01



2 17247.07



5 17250.02



7 RN14YC



4 17251.01



6 17248.04



3 17252.03



We now proudly carry the complete line of Champion Spark Plugs for JEEP®.

1 IGNITION WIRE SETS

DESCRIPTION	PART #
1941-45 MB 4-CYL 134 L-HEAD	17245.01
1945-49 CJ2A 4-CYL 134 L-HEAD	17245.01
1948-53 CJ3A 4-CYL 134 L-HEAD	17245.01
1954-71 CJ F-HEAD 4-CYL 134	17245.02
1972-77 6 CYL ALL	17245.08
1974-92 V8 CJ	17245.13
1978-86 6 CYL 4.2L CJ	17245.09
1983-86 4 CYL AMC 150, CJ	17245.05
1948-63 6 CYL 226	17245.07
1974-92 V8 SJ	17245.13
1978-90 6 CYL 4.2L SJ	17245.09
1987-90 4 CYL AMC 150, WRANGLER	17245.05
1987-90 6 CYL 4.2L WRANGLER	17245.09
1978-87 6 OR 8 CYL SJ	17252.02
1988-90 SJ	17252.03
1987 4, OR 6 CYL WRANGLER	17252.02
1988-90 WRANGLER	17252.03
1984-86 4 CYL CHEROKEE	17252.02
1988-90 CHEROKEE	17252.03

3 IGNITION MODULES

DESCRIPTION	PART #
1941-71 4 CYL 134 ENGINE WITH ELECTRONIC DISTRIBUTOR (service replacement part for #17239.01)	17252.05
1975-77 6 OR 8 CYL, PRESTOLITE IGNITION	17252.01
1978-86 4, 6 OR 8 CYL CJ	17252.02
1978-87 6 OR 8 CYL SJ	17252.02
1988-90 SJ	17252.03
1987 4, OR 6 CYL WRANGLER	17252.02
1988-90 WRANGLER	17252.03
1984-86 4 CYL CHEROKEE	17252.02
1988-90 CHEROKEE	17252.03

4 IGNITION SWITCHES

DESCRIPTION	PART #
1941-63 ALL EARLY MODEL FLOOR TYPES	17251.01
1976-86 CJ WITH TILT	17251.03
1976-86 CJ WITHOUT TILT STEERING	17251.02
1987-95 WRANGLER WITH TILT	17251.03
1987-95 WRANGLER WITHOUT TILT STEERING	17251.02
1997-00 WRANGLER WITHOUT TILT	17251.07
2001-06 WRANGLER	17251.04
1997-01 CHEROKEE WITHOUT TILT	17251.07
1994-96 GRAND CHEROKEE	17251.05
1996-98 GRAND CHEROKEE	17251.08
2001-04 GRAND CHEROKEE	17251.06

5 IGNITION LOCK & CYLINDERS WITH KEYS

DESCRIPTION	PART #
1946-66 ALL, THREADED TERMINALS	17250.01
1966-69 CJ W/ PUSH TERMINALS	17250.02
1976-86 CJ	17250.03
1976-86 SJ	17250.03
1987-90 WRANGLER	17250.04
1990-95 WRANGLER	17250.05
1997-03 WRANGLER	17250.09
1987-90 CHEROKEE	17250.04
1990-95 CHEROKEE	17250.05
1997-01 CHEROKEE	17250.09
1997-98 GRAND CHEROKEE	17250.08
1999-03 GRAND CHEROKEE	17250.09
2002-03 LIBERTY	17250.09

6 AUTOLITE SPARK PLUGS

DESCRIPTION	PART #
1941-45 MB	17248.03
1945-71 CJ	17248.03
1953-72 M38, M38A1 24V (MFG#2243)	17248.01
1953-72 M38, M38A1 24V (MFG#2245)	17248.02
1954-63 WILLYS TRUCK & WAGON 6 CYL 226	17248.03
1972-77 6 CYL 232, 258	17248.05
1972-93 8 CYL, ALL	17248.05
1978-79 6 CYL 232, 258	17248.06
1980-94 6 CYL 4.2L OR 4.0L, ALL	17248.04
1984-93 4 CYL CJ	17248.04
1984-93 4 CYL WRANGLER	17248.04
1987-90 4.0L CHEROKEE	17248.07
1993-96 V8 GRAND CHEROKEE	17248.07
1997-98 V8 GRAND CHEROKEE	17248.08
1999 ALL	17248.08

7 CHAMPION SPARK PLUGS

DESCRIPTION	PART #
1941-71 2.2L(134) MB	RJ8C
1941-71 2.2L(134) CJ	RJ8C
1972-77 3.8L (232) CJ	RN14YC
1972-77 4.2L CJ	RN14YC
1972-81 5.0L (304) CJ	RN14YC
1978-80 3.8L (232) CJ	RN13LYC
1978-80 4.2L CJ	RN13LYC
1980-83 2.5L (151) GM CJ	RV17YC6
1981-86 4.2L CJ	RFN14LY
1983-86 2.5L (AMC) CJ	RFN14LY
1972-88 5.9L (360) SJ	RN14YC
1974-78 6.6L (401) SJ	RN14YC
1978-80 3.8L (232) SJ	RN13LYC
1978-80 4.2L SJ	RN13LYC
1981-88 4.2L SJ	RFN14LY
1987-90 4.2L WRANGLER	RFN14LY
1987-95 2.5L WRANGLER	RC12LYC
1991-95 4.0L WRANGLER	RC12LYC
1997-98 2.5L WRANGLER	RC12LYC
1997-98 4.0L WRANGLER	RC12LYC
1999-05 4.0L WRANGLER	RC12ECC
1999-2002 2.5L WRANGLER	RC12ECC
2003-04 2.4L WRANGLER	RE14MCC5
2007-10 3.7L WRANGLER (NEW)	RE14PLP5
1984-85 2.5L CHEROKEE	RFN14LY
1984-86 2.8L V6 CHEROKEE	RV12YC
1986-98 2.5L CHEROKEE	RC12LYC
1987-90 4.0L CHEROKEE	RC9YC
1991-98 4.0L CHEROKEE	RC12LYC
1999-00 2.5L CHEROKEE	RC12ECC
1999-01 4.0L CHEROKEE	RC12ECC
1993-96 5.2L GRAND CHEROKEE	RC12YC
1993-98 4.0L GRAND CHEROKEE	RC12LYC
1997-98 5.2L GRAND CHEROKEE	RC12LC4
1998 5.9L GRAND CHEROKEE	RC12LC4
1999-04 4.0L GRAND CHEROKEE	RC12ECC
1999-04 4.7L GRAND CHEROKEE	RC12MCC4
2002-04 4.7L HO GRAND CHEROKEE	RC7PYCB4
2005 4.7L GRAND CHEROKEE	RC12MCC4
2002-04 2.4L LIBERTY	RE14MCC5
2002-04 3.7L LIBERTY	RC9YC

2 IGNITION COILS

DESCRIPTION	PART #
1941-62 6V	17247.01
1963-71 12V 4 CYL	17247.02
1972-74 6 OR 8 CYL, ALL	17247.06
1975-77 6 OR 8 CYL, PRESTOLITE IGNITION	17247.07
1978-86 6 CYL 4.2L CJ	17247.03
1978-90 6 CYL 4.2L SJ	17247.03
1987-90 4 CYL WRANGLER	17247.03
1987-90 6 CYL 4.2L WRANGLER	17247.03
1991-97 2.5L WRANGLER	17247.04
1991-97 WRANGLER 4.0L	17247.04
1998-02 2.5L WRANGLER	17247.05
1999-06 GRAND CHEROKEE (NEW)	17247.11
2000-03 4 CYL WRANGLER 2.4L (NEW)	17247.12
2004-06 4 CYL WRANGLER 2.4L	17247.13
1983-86 4 CYL CHEROKEE	17247.03
1984-86 2.8L V6 CHEROKEE	17247.08
1984-90 4 CYL CHEROKEE	17247.03
1987-90 4 OR 6 CYL CHEROKEE	17247.09
W/ FUEL INJ.	17247.04
1991-97 2.5L CHEROKEE	17247.04
1991-97 CHEROKEE 4.0L	17247.04
1998-01 2.5L CHEROKEE	17247.05
1993-97 GRAND CHEROKEE 4.0L/5.2L	17247.04
1998 GRAND CHEROKEE	17247.05
1999-04 V8 GRAND CHEROKEE 4.7L (NEW)	17247.11
2005 V6 3.7L GRAND CHEROKEE (NEW)	17247.14
2005-07 V8 4.7L GRAND CHEROKEE (NEW)	17247.11
2005-07 V6 3.7L GRAND CHEROKEE (NEW)	17247.11
1998-02 ALL 2.5L	17247.05
1998-99 6 CYL	17247.05
1998-99 ALL 4.0L	17247.05
2002-07 V6 3.7L LIBERTY (NEW)	17247.11
2002-06 4 CYL LIBERTY 2.4L (NEW)	17247.12
2002-06 4 CYL LIBERTY 2.4L (NEW)	17247.12
2004-05 4 CYL LIBERTY 2.4L	17247.13
2004-06 V6 LIBERTY 3.7L (NEW)	17247.14
2006 6 CYL LIBERTY 2.8L	17247.13

ELECTRICAL PARTS



1

17253.01

17255.03

17254.05

2

11249.02



17214.01



17214.02



11214.01



8

11214.52



1 TUNE-UP KITS

DESCRIPTION	PART #
1941-45 4 CYL MB	17257.71
1946-49 4 CYL CJ2A	17257.72
1948-53 4 CYL CJ3A	17257.72
1948-59 6 CYL 226 (with drop-in oil filter)	17257.77
1953-63 4-CYL CJ (models with drop-in oil filter)	17257.73
1960-63 6 CYL 226 (with screw-on disposable oil filter)	17257.78
1964-71 4 CYL CJ (with screw-on disposable oil filter)	17257.74
1972-73 6 CYL CJ (with point set)	17257.79
1972-74 V8 CJ (with point set)	17257.82
1974 6 CYL CJ (with point set)	17257.80
1975-77 6 CYL CJ (with Prestolite distributor)	17257.81
1975-77 V8 CJ (with Prestolite distributor)	17257.83
1978-79 6 CYL CJ 4.2L	17256.27
1978-81 V8 CJ 304	17256.30
1980-82 6 CYL CJ 4.2L	17256.28
1983-86 4 CYL CJ W/ 2.5L AMC engine (will not fit 1983 4 cyl CJ w/ GM engine)	17257.85
1983-86 6 CYL CJ 4.2L	17256.29
1987-90 4 CYL WRANGLER 2.5L	17256.12
1987-90 6 CYL WRANGLER 4.2L	17256.01
1991-93 4 CYL WRANGLER 2.5L WITH CARB	17256.14
1991-93 4 CYL WRANGLER 2.5L WITH EFI	17256.13
1991-93 6 CYL WRANGLER 4.0L	17256.02
1994-95 4 CYL WRANGLER 2.5L	17256.15
1994-95 6 CYL WRANGLER 4.0L	17256.03
1997-98 4 CYL WRANGLER 2.5L	17256.16
1997-98 6 CYL WRANGLER 4.0L	17256.04
1999-00 4 CYL WRANGLER 2.5L	17256.26
1999-00 6 CYL WRANGLER 4.0L	17256.25
1987-90 4 CYL CHEROKEE 2.5L	17256.17
1987-90 6 CYL CHEROKEE 4.0L	17256.05
1991-93 4 CYL CHEROKEE 2.5L WITH CARB	17256.18
1991-93 4 CYL CHEROKEE 2.5L WITH EFI	17256.19
1991-93 6 CYL CHEROKEE 4.0L	17256.06
1994-96 4 CYL CHEROKEE 2.5L	17256.20
1994-96 6 CYL CHEROKEE 4.0L	17256.07
1997-98 4 CYL CHEROKEE 2.5L	17256.21
1997-98 6 CYL CHEROKEE 4.0L	17256.08
1999-00 4 CYL CHEROKEE 2.5L	17256.22
1999-00 6 CYL CHEROKEE 4.0L	17256.09
1993-96 6 CYL GRAND CHEROKEE 4.0L	17256.10
1993-96 V8 GRAND CHEROKEE	17256.23
1997-98 6 CYL GRAND CHEROKEE 4.0L	17256.11
1997-98 V8 GRAND CHEROKEE	17256.24
1999-02 6 CYL GRAND CHEROKEE 4.0L (NEW)	17256.35
1999-02 V8 4.7L GRAND CHEROKEE (NEW)	17256.36

2 REPLACEMENT HORNS

DESCRIPTION	PART #
1976-86 CJ, LOW TONE	17249.01
1976-86 CJ, HIGH TONE	17249.02
1987-95 WRANGLER, LOW TONE	17249.01
1987-95 WRANGLER, HIGH TONE	17249.02

3 RADIO ANTENNA KITS

DESCRIPTION	PART #
1976-86 CJ CHROME	17214.01
1976-86 CJ BLACK	17214.02
1987-95 WRANGLER CHROME	17214.01
1987-95 WRANGLER BLACK	17214.02

4 BATTERY TRAY KITS

DESCRIPTION	PART #
1976-86 CJ, KIT, BLACK (includes clamp)	11214.01
1976-86 CJ, STAINLESS STEEL BATTERY TRAY	17260.01
1976-86 CJ, STAINLESS STEEL, KIT (includes clamp)	11132.01
1976-86 CJ, BATTERY TRAY CLAMP ONLY, BLACK	17260.02

5 ATO FUSES

DESCRIPTION	PART #
5 AMP	17253.01
7.5 AMP	17253.02
10 AMP	17253.03
15 AMP	17253.04
20 AMP	17253.05
25 AMP	17253.06
30 AMP	17253.07

6 MINI-FUSES

DESCRIPTION	PART #
3 AMP	17255.01
10 AMP	17255.02
15 AMP	17255.03
20 AMP	17255.04
30 AMP	17255.05

7 MAXI-FUSES

DESCRIPTION	PART #
20 AMP	17254.01
30 AMP	17254.02
40 AMP	17254.03
50 AMP	17254.04
60 AMP	17254.05

8 DUAL BATTERY TRAY KITS

DESCRIPTION	PART #
70-90 CJ & Wrangler (NEW)	11214.50
91-95 Wrangler (NEW)	11214.51
97-06 Wrangler (NEW)	11214.52

VALVE COVERS



DMC-6914



DMC-6920



17401.09



17401.08



17401.03



17401.07



17402.02



17404.03

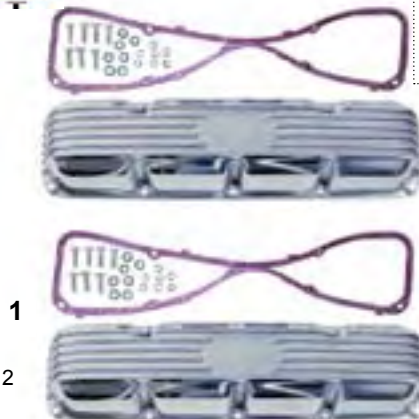

17401.12



17447.01



2



17403.01

1 VALVE COVERS

DESCRIPTION	PART #
1981-86 6 CYLINDER "JEEP" MARKED VALVE COVER W/ GASKET & HARDWARE	DMC-6914
1966-91 V8 AMC "JEEP" MARKED VALVE COVER, (pair) W/ GASKET & HARDWARE	DMC-6920
1966-91 AMC V8 (304, 360, 390, 401)	
POLISHED ALUMINUM VALVE COVER, PAIR (NEW)	17401.12
1966-91 AMC V8 (304, 360, 390, 401)	
BLACK ALUMINUM VALVE COVER, PAIR (NEW)	17401.13
1987-96 4 CYLINDER 2.5L PLASTIC VALVE COVER W/O GASKET & HARDWARE	17401.01
1981-86 6 CYLINDER 258 AMC, PLASTIC VALVE COVER (inc. hardware)	17401.03
1981-86 6 CYLINDER PLASTIC VALVE COVER W/ CORK GASKET	17401.04
1981-86 6 CYLINDER PLASTIC VALVE COVER W/ OE STYLE RUBBER GASKET	17401.05
1981-86 6 CYLINDER PLASTIC VALVE COVER W/ GASKET & 2 STUDDER BRIDGES (rocker arm)	17401.06
1981-86 6 CYLINDER ALUMINUM VALVE COVER W/ GASKET (Omix logo)	17401.07
1981-86 6 CYLINDER ALUMINUM VALVE COVER W/ GASKET ("4.2L" logo)	17401.08
1981-86 6 CYLINDER ALUMINUM VALVE COVER W/ GASKET ("4.2L" logo) POLISHED	17401.09
1981-86 6 CYLINDER ROCKER ARM BRIDGE W/O STUD (use 2 w/ aluminum valve covers)	17408.11
1966-91 AMC V8 (304, 360, 390, 401)	
ALUMINUM VALVE COVER PAIR W/HARDWARE	17401.10
1981-86 REPLACEMENT HARDWARE KIT W/ GASKET FOR 6 CYLINDER ALUMINUM VALVE COVER	17402.01
1981-86 REPLACEMENT GASKET ONLY FOR 6 CYLINDER ALUMINUM VALVE COVER	17447.05

3 VALVE COVER GROMMETS

DESCRIPTION	PART #
1973-91 V8 304, 360, 390, 401	17402.05
1976-80 6 CYLINDER 232 OR 258	17402.03
1981-90 6 CYLINDER 258 (4.2L)	17402.02
1982-86 4 CYLINDER GM OR AMC 2.5L	17402.02

2 VALVE COVER GASKETS

DESCRIPTION	PART #
1952-71 4 CYLINDER F-HEAD	17447.01
1965-80 6 CYLINDER 232 OR 258	17447.02
1970-91 V8 (all)	17447.06
1981-86 6 CYLINDER 258 (cork)	17447.03
1981-86 6 CYLINDER 258 4.2L (OE style rubber gasket)	17447.04
1981-86 6 CYLINDER 258 4.2L (w/ aluminum valve cover)	17447.05
1996-01 4.0L CHEROKEE	17447.09
1996-06 4.0L WRANGLER	17447.09
2003-06 2.4L WRANGLER	17447.07
1993-98 5.2L & 5.9L GRAND CHEROKEE	17447.08
1996-98 4.0L GRAND CHEROKEE	17447.09
1999-03 4.7L GRAND CHEROKEE, LH	17447.10
1999-03 4.7L GRAND CHEROKEE, RH	17447.12
1999-04 4.0L GRAND CHEROKEE	17447.09
2002-06 2.4L LIBERTY	17447.07
2002-06 3.7L, LH	17447.11
2002-06 3.7L, RH	17447.13

4 OIL CAPS

DESCRIPTION	PART #
1971-91 V8 AMC	17403.04
1974-80 6 CYLINDER AMC 232 OR 258	17403.01
1980-82 4 CYLINDER GM 151	17403.01
1983-93 4 CYLINDER AMC 2.5L	17403.02
1981-90 6 CYLINDER 4.2L OR 4.0L	17403.02
1994-98 V8 GRAND CHEROKEE	17403.03
1987-06 ALL 4.0L	17403.03

5 PCV VALVES

DESCRIPTION	PART #
1971-83 V8	17404.03
1980-93 CJ 2.5L 4 CYLINDER	17404.01
1980-93 YJ 2.5L 4 CYLINDER	17404.01
1980-93 XJ 2.5L 4 CYLINDER	17404.01
1983-86 6 CYLINDER	17404.02
1993 V8 GRAND CHEROKEE	17404.04
1994-98 V8 GRAND CHEROKEE	17404.05

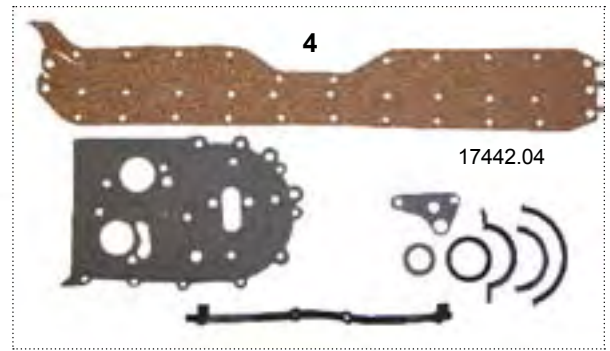
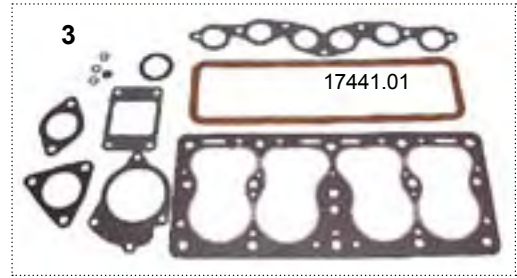
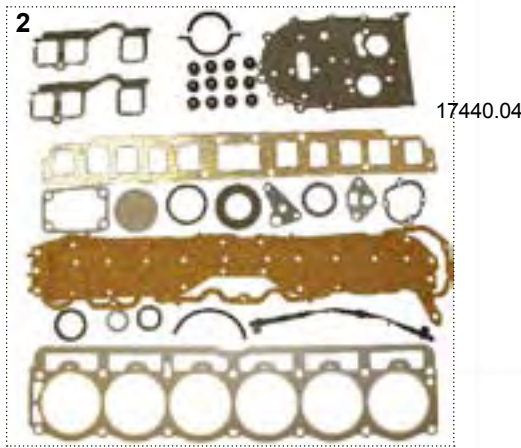

1 ENGINE KITS

ENGINE KITS INCLUDE: PISTONS, RINGS, MAIN & ROD BEARINGS, CAM BEARING, TIMING KIT, FULL GASKET/SEAL SET, 8 VALVES, 8 VALVE GUIDES, OIL PUMP & ENGINE MOUNTS. KIT AVAILABLE IN STANDARD PISTON, MAIN & ROD BEARING SIZE ONLY.

DESCRIPTION	PART #
1941-47 L-HEAD 134 W/ TIMING CHAIN MB & EARLY CJ2A	17405.01
1948-71 L-HEAD 134 W/ TIMING GEAR	17405.02
1954-71 F-HEAD 4 CYLINDER 134 ENGINE	17405.03

2 OVERHAUL GASKET & SEAL KITS

DESCRIPTION	PART #
1941-53 4 CYLINDER L-HEAD	17440.01
1952-71 4 CYLINDER F-HEAD	17440.02
1968-80 6 CYLINDER AMC 199, 232 OR 258	17440.04
1981-90 6 CYLINDER 4.2L	17440.05
1987-90 6 CYLINDER 4.0L	17440.06
1971-92 V8 AMC 304	17440.07
1971-92 V8 AMC 360 OR 401	17440.08

3 UPPER GASKET SETS

DESCRIPTION	PART #
1941-53 L-HEAD 4 CYLINDER	17441.01
1952-71 F-HEAD 4 CYLINDER	17441.02
1966-71 6 CYLINDER 225 V6 (NEW)	17441.12
1980-83 4 CYLINDER CJ W/ 151 GM ENGINE	17441.03
1983-86 4 CYLINDER AMC 2.5L	17441.04
1987-93 4 CYLINDER 2.5L	17441.05
1965-80 6 CYLINDER 232 OR 258	17441.06
1981-90 6 CYLINDER 258	17441.07
1987-90 6 CYLINDER 4.0L	17441.08
1991-00 6 CYLINDER 4.0L	17441.09
1970-83 V8 304	17441.10
1970-92 V8 360 OR 401	17441.11

4 LOWER GASKET SETS

DESCRIPTION	PART #
1980-83 4 CYLINDER CJ W/ 151 GM ENGINE	17442.01
1983-92 4 CYLINDER AMC 2.5L	17442.02
1993-02 4 CYLINDER 2.5L	17442.03
1965-90 6 CYLINDER 232, 258	17442.04
1987-91 6 CYLINDER 4.0L	17442.04
1992-00 6 CYLINDER 4.0L	17442.06
1966-71 6 CYLINDER 225 V6	17442.08
2002-06 V6 3.7L (NEW)	17442.09
1971-92 V8 304, 360, 401	17442.07
2006 V8 4.7L	17442.10

5 CRANKSHAFT PILOT BEARINGS

DESCRIPTION	PART #
1941-71 4 CYLINDER 134	16910.01
1980-83 4 CYLINDER GM 151	16910.02
1983-99 4 CYLINDER	16910.03
2003-04 4 CYLINDER 2.4L WRANGLER	16910.10
2002-04 4 CYLINDER 2.4L LIBERTY	16910.10
1972-76 6 CYLINDER	16910.04
1976-79 6 CYLINDER	16910.05
1982-86 6 CYLINDER	16910.06
1987-91 6 CYLINDER	16910.07
1992-00 6 CYLINDER 4.0L	16910.08
1972-76 V8	16910.04
1976-79 V8	16910.05
1982-86 V8	16910.06

6 FRONT & REAR CRANKSHAFT OIL SEALS

DESCRIPTION	PART #
1941-71 4 CYLINDER 134 REAR (4-piece kit)	17458.01
1980-83 4 CYLINDER GM 151, REAR (NEW)	17458.07
1983-02 4 CYLINDER 2.5L, REAR	17458.02
1965-90 6 CYLINDER 232 OR 258 FRONT	17459.01
1968-90 6 CYLINDER 232 OR 258 (2-piece kit)	17458.03
1970-91 V8 AMC, REAR	17458.04
2002-06 2.4L (NEW)	17466.63

7 INTAKE MANIFOLD

DESCRIPTION	PART #
1941-53 4 CYLINDER 134 L-HEAD	17738.01
1966-71 V6 225 (NEW)	17445.01
1999-06 4.7L (NEW)	17445.03

8 CYLINDER HEAD

DESCRIPTION	PART #
1987-90 4.2L WRANGLER	17407.01

9 CYLINDER HEAD GASKETS

DESCRIPTION	PART #
1941-53 4 CYLINDER L-HEAD	17446.01
1952-71 4 CYLINDER F-HEAD	17446.02
1966-71 6 CYLINDER 225 V6 (NEW)	17446.10
2002-08 V6 3.7L (NEW)	17466.11
1983-02 4 CYLINDER 2.5L	17446.03
1948-63 6 CYLINDER 226	17446.09
1968-90 6 CYLINDER AMC 199, 232 OR 258	17446.04
1987-96 6 CYLINDER 4.0L	17446.05
1997-06 6 CYLINDER 4.0L (NEW)	17466.09
1967-92 V8 AMC - HEAVY DUTY	17446.08
1971-91 V8 AMC 304	17446.06
1971-91 V8 AMC, 360 OR 401	17446.07
1999-06 V8 4.7L	17466.10

ENGINE BEARINGS

1 MAIN BEARING SETS

(complete set per engine)

DESCRIPTION	PART #
1941-71 4 CYLINDER 134:	
STANDARD	17465.01
.010 OVER	17465.02
.020 OVER	17465.03
.030 OVER	17465.04
.040 OVER	17465.05
.050 OVER	17465.06
.060 OVER	17465.07
.070 OVER	17465.08
.080 OVER	17465.09
1983-90 4 CYLINDER 2.5L:	
STANDARD	17465.12
.010 OVER	17465.13
.020 OVER	17465.14
.030 OVER	17465.15
1991-02 4 CYLINDER 2.5L & 1997-06 4.0L	
STANDARD (NEW)	17465.18
.010 OVER (NEW)	17465.19
.020 OVER (NEW)	17465.20
.030 OVER (NEW)	17465.21
.040 OVER (NEW)	17465.22
2002-06 4 CYLINDER 2.4L:	
STANDARD (NEW)	17465.65
.010 OVER (NEW)	17465.66
.020 OVER (NEW)	17465.67
.030 OVER (NEW)	17465.68
.040 OVER (NEW)	17465.69
1948-64 6 CYLINDER 226:	
STANDARD	17465.27
.010 OVER	17465.28
.020 OVER	17465.29
.030 OVER	17465.30
.040 OVER	17465.31
.060 OVER	17465.32
1968-90 6 CYLINDER 199, 232, 258 (4.2L) & 242 (4.0L):	
STANDARD	17465.35
.010 OVER	17465.36
.020 OVER	17465.37
.030 OVER	17465.38
1991-96 4.0L 6 CYLINDER:	
STANDARD	17465.42
.010 OVER	17465.43
.020 OVER	17465.44
.030 OVER	17465.45
1991-96 4.0L 6 CYLINDER:	
.020 OVER	17465.44
.030 OVER	17465.45
2002-06 6 CYLINDER 3.7L:	
STANDARD (NEW)	17465.75
.010 OVER (NEW)	17465.76
.020 OVER (NEW)	17465.77
.030 OVER (NEW)	17465.78
.040 OVER (NEW)	17465.79
1971-92 AMC 304 OR 360 V8:	
STANDARD	17465.49
.010 OVER	17465.50
.020 OVER	17465.51
.030 OVER	17465.52
1970 AMC 401 V8:	
STANDARD	17465.56
.010 OVER	17465.57
.020 OVER	17465.58
.030 OVER	17465.59
1993-98 5.2L V8:	
STANDARD (NEW)	17465.80
.010 OVER (NEW)	17465.81
.020 OVER (NEW)	17465.82
.030 OVER (NEW)	17465.83
.040 OVER (NEW)	17465.84
1997-98 5.9L V8:	
STANDARD (NEW)	17465.90
.010 OVER (NEW)	17465.91
.020 OVER (NEW)	17465.92
.030 OVER (NEW)	17465.93
.040 OVER (NEW)	17465.94
1999-06 4.7L V8:	
STANDARD (NEW)	17465.70
.010 OVER (NEW)	17465.71
.020 OVER (NEW)	17465.72
.030 OVER (NEW)	17465.73

2 CONNECTING ROD BEARINGS

(PART #'S ARE FOR EACH CONNECTING ROD, NOT A COMPLETE SET)

DESCRIPTION	PART #
1941-71 4 CYLINDER 134:	
STANDARD, Each	17467.01
.010 OVER, Each	17467.02
.020 OVER, Each	17467.03
.030 OVER, Each	17467.04
.040 OVER, Each	17467.05
.050 OVER, Each	17467.06
.060 OVER, Each	17467.07
.070 OVER, Each	17467.08
.080 OVER, Each	17467.09
1948-64 6 CYLINDER 226 ODD # CYLINDERS (1,3,5):	
STANDARD, Each	17467.12
.010 OVER, Each	17467.13
.020 OVER, Each	17467.14
.030 OVER, Each	17467.15
.040 OVER, Each	17467.16

2 CONNECTING ROD BEARINGS

(PART #'S ARE FOR EACH ROD, NOT A COMPLETE SET)

DESCRIPTION	PART #
1948-64 6 CYLINDER 226 ODD # CYLINDERS (1,3,5):	
STANDARD, Each	17467.12
.010 OVER, Each	17467.13
.020 OVER, Each	17467.14
.030 OVER, Each	17467.15
.040 OVER, Each	17467.16
1948-64 6 CYLINDER 226 EVEN # CYLINDERS (2,4,6):	
STANDARD, Each	17467.18
.010 OVER, Each	17467.19
.020 OVER, Each	17467.20
.030 OVER, Each	17467.21
.040 OVER, Each	17467.22
1983-02 4 CYLINDER 2.5L, 1968-90 6 CYLINDER AMC,	
1987-99 4.0L, 1972-92 V8 304-360:	
STANDARD, Each	17467.24
.001 OVER, Each	17467.25
.010 OVER, Each	17467.26
.020 OVER, Each	17467.27
.030 OVER, Each	17467.28
1976-93 V8 AMC 401:	
STANDARD, Each	17467.32
.010 OVER, Each	17467.33
.020 OVER, Each	17467.34
.030 OVER, Each	17467.35
1993-98 V8 5.2L GRAND CHEROKEE:	
STANDARD, Each	17467.39
.001 OVER, Each	17467.40
.002 OVER, Each	17467.41
.010 OVER, Each	17467.42

2 CONNECTING ROD BEARING SETS

(PART #'S ARE FOR SETS, USE ONE SET PER ENGINE)

DESCRIPTION	PART #
1941-71 4 CYLINDER 134:	
STANDARD (NEW)	17467.60
.010 OVER (NEW)	17467.61
.020 OVER (NEW)	17467.62
.030 OVER (NEW)	17467.63
.040 OVER (NEW)	17467.64
.050 OVER (NEW)	17467.65
.060 OVER (NEW)	17467.66
.070 OVER (NEW)	17467.67
.080 OVER (NEW)	17467.68
2002-06 4 CYLINDER 2.4L:	
STANDARD (NEW)	17467.55
.010 OVER (NEW)	17467.56
.020 OVER (NEW)	17467.57
.030 OVER (NEW)	17467.58
2002-06 6 CYLINDER 3.7L:	
.020 OVER (NEW)	17467.72
.030 OVER (NEW)	17467.73
.040 OVER (NEW)	17467.74
1993-98 5.2L V8:	
STANDARD (NEW)	17467.80
.001 OVER (NEW)	17467.81
.010 OVER (NEW)	17467.82
.020 OVER (NEW)	17467.83
.030 OVER (NEW)	17467.84
.040 OVER (NEW)	17467.85
1999-06 4.7L V8:	
STANDARD (NEW)	17467.50
.010 OVER (NEW)	17467.51
.020 OVER (NEW)	17467.52
.030 OVER (NEW)	17467.53
.040 OVER (NEW)	17467.54

3 CONNECTING RODS

DESCRIPTION	PART #
1941-71 ALL 4 CYLINDER (both L-head & F-head), CYLINDER 1 & 3	17469.01
1941-71 ALL 4 CYLINDER (both L-head & F-head), CYLINDER 2 & 4	17469.02
1968-76 6 CYL AMC 199, 232	17469.03
1977-82 6 CYL AMC 232, 258	17469.04
1983-90 6 CYL AMC 258 (4.2L)	17469.05
1941-71 4 CYL 134 (after s/n 89737)	
CONNECT ROD BOLT & NUT 3/8 x 24	17470.12

4 PISTONS WITH PINS

(PISTONS ARE SOLD SEPARATELY, NOT A SET)

DESCRIPTION	PART #
1941-71 4 CYLINDER 134	
STANDARD	17427.01
.020 OVER	17427.02
.030 OVER	17427.03
.040 OVER	17427.04
.060 OVER	17427.05
.080 OVER	17427.06
1983-93 4 CYLINDER 2.5L	
STANDARD	17427.07
.010 OVER	17427.11
.020 OVER	17427.08
.030 OVER	17427.09
.040 OVER	17427.10
1996-06 4 CYLINDER 2.5L STANDARD	17427.12
1948-63 6 CYLINDER 226	
STANDARD	17427.13
.030 OVER	17427.15
.040 OVER	17427.16
.060 OVER	17427.17
1948-64 6 CYL 226 PISTON PIN	
BUSHING SET (6 pcs)	17428.01

4 PISTONS WITH PINS

(PISTONS ARE SOLD SEPARATELY, NOT A SET)

DESCRIPTION	PART #
1966-78 6 CYLINDER 232 OR 258	
STANDARD	17427.18
.020 OVER	17427.19
.030 OVER	17427.20
1966-71 6 CYLINDER 225 V6:	
STANDARD (NEW)	17427.30
.020 OVER (NEW)	17427.31
.030 OVER (NEW)	17427.32
.040 OVER (NEW)	17427.33
1979-90 6 CYLINDER 4.2L (258)	
STANDARD	17427.21
.020 OVER	17427.22
.030 OVER	17427.29
1987-93 6 CYLINDER 4.0L STANDARD	17427.07
1983-93 6 CYLINDER 4.0L	
.010 OVER	17427.11
.020 OVER	17427.08
.030 OVER	17427.09
.040 OVER	17427.10
1996-00 6 CYLINDER 4.0L, STANDARD	17427.12
1970-91 V8 AMC 304	
STANDARD	17427.23
.030 OVER	17427.24
1970-91 V8 AMC 360	
STANDARD	17427.25
.030 OVER	17427.26
1970-78 V8 AMC 401	
STANDARD	17427.27
.030 OVER	17427.28

5 PISTON RING SETS

(RING SETS SOLD PER ENGINE, UNLESS NOTED)

DESCRIPTION	PART #
1941-71 4 CYLINDER 134:	
STANDARD	17430.01
.020 OVER	17430.02
.030 OVER	17430.03
.040 OVER	17430.04
.060 OVER	17430.05
.080 OVER	17430.06
1983-93 4 CYLINDER 2.5L AMC:	
STANDARD	17430.09
.010 OVER	17430.10
.020 OVER	17430.11
.030 OVER	17430.12
1947-63 6 CYLINDER 226:	
STANDARD	17430.13
.010 OVER	17430.14
.020 OVER	17430.15
.030 OVER	17430.16
.040 OVER	17430.17
.060 OVER	17430.18
1966-71 6 CYLINDER 225 V6:	
STANDARD (NEW)	17430.50
.010 OVER (NEW)	17430.50
.020 OVER (NEW)	17430.51
.030 OVER (NEW)	17430.52
.040 OVER (NEW)	17430.53
.060 OVER (NEW)	17430.54
1968-90 6 CYL 199, 232 OR 258:	
STANDARD	17430.19
.020 OVER	17430.20
.030 OVER	17430.21
.040 OVER	17430.22
.060 OVER	17430.23
1987-93 6 CYLINDER 4.0L (242):	
STANDARD	17430.24
.010 OVER	17430.25
.020 OVER	17430.26
.030 OVER	17430.27
1971-91 AMC V8 304:	
STANDARD	17430.28
.020 OVER	17430.29
.030 OVER	17430.30
1971-91 AMC V8 360:	
STANDARD	17430.31
.010 OVER	17430.32
.020 OVER	17430.33
.030 OVER	17430.34
1970-78 AMC 401:	
STANDARD	17430.35
.020 OVER	17430.36
.030 OVER	17430.37
1993-98 V8 5.2L GRAND CHEROKEE:	
STANDARD	17430.38
.020 OVER	17430.39
.030 OVER	17430.40
1999-04 V8 4.7L GRAND CHEROKEE:	
STANDARD (NEW)	17430.45
.025 OVER (NEW)	17430.46
.050 OVER (NEW)	17430.47
.010 OVER (NEW)	17430.49
1966-71 6 CYLINDER 225:	
STANDARD (NEW)	17430.50
1999-06 V8 4.7L:	
STANDARD (NEW)	17430.46
.020 OVER (NEW)	17430.47
.040 OVER (NEW)	17430.49

5 PISTON RING SETS

(PART #'S ARE FOR SETS, USE ONE SET PER ENGINE)

DESCRIPTION	PART #
1966-71 6 CYLINDER 225:	
STANDARD (NEW)	17430.50
1999-06 V8 4.7L:	
STANDARD (NEW)	17430.46
.020 OVER (NEW)	17430.47
.040 OVER (NEW)	17430.49

CAMSHAFT & TIMING



1 CAMSHAFTS

DESCRIPTION	PART #
1941-45 MB WITH CHAIN TIMING (limited quantity)	17421.01
1945-48 CJ2A WITH CHAIN TIMING (limited quantity)	17421.01
1953-71 4 CYLINDER F-HEAD 134 CAMSHAFT	17421.03
1964-66 6 CYLINDER 230 TORNADO CAMSHAFT	17421.06
1966-71 6 CYLINDER 232 V6	17421.12
1965-78 6 CYLINDER 232 OR 258 CAMSHAFT	17421.07
1971-93 V8 304, 360 OR 401 CAMSHAFT (each)	17421.10
1979-90 6 CYLINDER 258 CAMSHAFT	17421.08
1983-95 4 CYLINDER 2.5L, CAMSHAFT	17421.04
1987-95 6 CYLINDER 4.0L CAMSHAFT	17421.09
1996-02 4 CYLINDER 2.5L, CAMSHAFT (NEW)	17421.14

2 CAMSHAFT SEAL

DESCRIPTION	PART #
2002-06 4 CYLINDER 2.4L (NEW)	17466.63

3 CAMSHAFT & LIFTER KITS (camshaft kit includes includes: camshaft, lifters & 4 oz. assembly lube)

DESCRIPTION	PART #
1968-78 6 CYLINDER 232, 1971-76 258, 1977-78 258 W/ ONE BARREL CARB	17420.01
1979-80 6 CYL 258 W/ 2 BARREL CARB & MAN. TRANS	17420.01
1981-90 6 CYLINDER AMC 258 (4.2L)	17420.02
1971-91 V8 AMC 304, 360, 401	17420.03

4 CAMSHAFT BEARINGS

DESCRIPTION	PART #
1941-71 4 CYLINDER 134 (standard)	17422.01
1948-64 6 CYLINDER 226	17422.05
1968-90 6 CYLINDER 199, 232 OR 258 4.2L (standard)	17422.03
1968-90 6 CYLINDER 199, 232 OR 258 4.2L .010 OVER	17422.04
1983-02 4 CYLINDER 2.5L (standard)	17422.03
1983-99 4 CYLINDER 2.5L .010 OVER	17422.04
1987-99 6 CYLINDER 4.0L (standard)	17422.03
1987-99 6 CYLINDER 4.0L .010 OVER	17422.04
1971-92 AMC V8 (standard)	17422.06
1966-71 V6 225 CJ5, CJ6 (standard)	17422.07
1993-98 V8 5.2L/5.9L GRAND CHEROKEE (standard) (NEW)	17422.09

5 VALVE LIFTERS

DESCRIPTION	PART #
1955-71 4 CYLINDER 134 (F-head intake)	17418.01
1983-02 4 CYLINDER 2.5L (order 8 for set)	17418.03
1974-90 6 CYLINDER 232 TO 258 (order 12 for set)	17418.03
1987-96 6 CYLINDER 4.0L (order 12 for set)	17418.03
1971-93 V8 AMC, (order 16 for set)	17418.03
1993-98 V8 GRAND CHEROKEE (order 16 for set)	17418.04

6 DISTRIBUTOR DRIVE GEARS

DESCRIPTION	PART #
1967-91 AMC V8, CAMSHAFT MOUNTED	17423.01
1967-91 AMC V8, DISTRIBUTOR MOUNTED	17423.02
1967-91 AMC V8, DISTRIBUTOR GEAR KIT (includes both camshaft and distributor mounted gears)	17423.03

7 TIMING SETS

(INCLUDES: CAM GEAR, CRANK GEAR & CHAIN (IF APPLICABLE))

DESCRIPTION	PART #
1941-45 4 CYLINDER MB (w/ chain)	17452.01
1945-47 4 CYLINDER CJ2A (w/ chain)	17452.01
1947-71 4 CYLINDER 134 CJ (w/o chain)	17452.02
1965-90 6 CYLINDER 232 OR 258	17452.06
1970-79 V8 5/8" TEETH WIDTH	17452.07
1980-93 V8 1/2" TEETH WIDTH	17452.08
1983-95 4 CYLINDER AMC 150 ENGINE	17452.03
1993-98 V8 5.2L GRAND CHEROKEE	17452.09

8 CRANKSHAFT PULLEYS & DAMPERS

DESCRIPTION	PART #
1941-45 MB, PULLEY SINGLE GROOVE	17460.03
1946-71 4 CYLINDER 134, PULLEY	17460.01
1972-86 6 CYL 258 (see OE applications), DAMPER	17461.01
1975-86 6 CYLINDER CJ (without AC), PULLEY	17460.02
1987-06 6 CYLINDER 4.0L, DAMPER	17461.02
1974-91 V8 AMC 360, DAMPER	17461.03

9 TIMING CHAINS

DESCRIPTION	PART #
1941-45 4 CYLINDER 134 MB	17453.01
1945-47 4 CYLINDER 134 CJ2A	17453.01
1948-58 6 CYLINDER 226	17453.04
1959-63 6 CYLINDER 226	17453.05
1963-67 6 CYLINDER 230	17453.07
1966-71 V6 225	17453.06
1968-90 6 CYLINDER 199, 232, 258 (4.2L)	17453.08
1971-92 V8 AMC, 1/2" WIDE	17453.12
1971-92 V8 AMC, 5/8" WIDE	17453.13
1983-02 4 CYLINDER 2.5L	17453.02
1983-02 4 CYLINDER 2.5L TENSIONER	17453.03
1987-01 6 CYLINDER 4.0L TENSIONER	17453.03
1987-93 6 CYLINDER 4.0L	17453.09
1993-98 V8 5.2L & 5.9L GRAND CHEROKEE	17453.14
1994-06 6 CYLINDER 4.0L	17453.10
1999-04 4.7L GRAND CHEROKEE (2 required)	17453.16
1999-06 3.7L & 4.7L GRAND CHEROKEE	17453.15
1999-06 3.7L LIBERTY	17453.15
2002-06 3.7L (2 required)	17453.17
2002-06 3.7L LIBERTY	17453.15

10 TIMING BELTS

DESCRIPTION	PART #
2003-06 4 CYLINDER 2.4L WRANGLER (NEW)	17453.18
2002-05 4 CYLINDER 2.4L LIBERTY (NEW)	17453.18

11 CRANKSHAFT GEARS OR SPROCKETS

DESCRIPTION	PART #
1941-45 4 CYLINDER 134 MB (models with chain)	17455.01
1945-47 4 CYLINDER 134 CJ2A (models with chain)	17455.01
1948-58 6 CYLINDER 226 (before s/n TW-6-6-90919)	17455.04
1948-71 4 CYLINDER 134 (models without chain)	17455.02
1959-63 6 CYLINDER 226 (after s/n TW-6-6-90919)	17455.05
1966-71 V6 225	17455.06
1968-90 6 CYLINDER AMC 199, 232, 258	17455.07
1971-91 V8 AMC 304, 360, 401, 1/2" WIDE	17455.11
1971-91 V8 AMC 304, 360, 401, 5/8" WIDE	17455.10
1983-02 4 CYLINDER 2.5L	17455.03
1987-93 6 CYLINDER 4.0L	17455.08
1993-98 V8 5.2L & 5.9L GRAND CHEROKEE	17455.12
1994-06 6 CYLINDER 4.0L	17455.09
1999-04 4.7L	17455.13
2002-06 3.7L	17455.13

12 CAMSHAFT GEARS OR SPROCKETS

DESCRIPTION	PART #
1941-45 4 CYLINDER 134 MB (models with chain)	17454.01
1945-47 4 CYLINDER 134 CJ2A (models with chain)	17454.01
1948-71 4 CYLINDER 134 (models without chain)	17454.02
1966-71 V6 225	17454.06
1968-90 6 CYL AMC 199, 232, 258, NYLON (for export)	17454.08
1968-90 6 CYL AMC 199, 232, 258, STEEL (for U.S. models)	17454.07
1971-91 V8 AMC 304, 360, 401, 1/2" WIDE	17454.12
1971-91 V8 AMC 304, 360, 401, 5/8" WIDE	17454.11
1983-01 4 CYLINDER 2.5L	17454.03
1987-93 6 CYLINDER 4.0L	17454.09
1993-98 V8 5.2L & 5.9L GRAND CHEROKEE	17454.13
1994-98 6 CYLINDER 4.0L	17454.10
1999-04 4.7L, RH CAMSHAFT SPROCKET	17454.16
1999-06 4.0L	17454.14
1999-06 4.7L, LH CAMSHAFT SPROCKET	17454.15
2002-06 LIBERTY 3.7L IDLER SPROCKET	17455.14
2002-06 LIBERTY 3.7L, LH CAMSHAFT SPROCKET	17454.17
2002-06 LIBERTY 3.7L, RH CAMSHAFT SPROCKET	17454.18

13 TIMING COVERS

DESCRIPTION	PART #
1965-90 6 CYLINDER 232 or 258	17457.01
1973-91 V8 AMC 304, 360, 401	17457.05
1975-92 6 CYL 4.2 & 4.0L (w/ molded rubber oil pan gasket)	17457.07
1983-90 4 CYLINDER 2.5L	17457.01
1983-92 2.5L (w/ molded rubber oil pan gasket)	17457.06
1993-02 4 CYLINDER 2.5L	17457.04
1993-01 6 CYLINDER 4.0L	17457.04
1993-02 2.5L ENGINE (w/ molded rubber oil pan gasket)	17457.02
1993-01 4.0L ENGINE (w/ molded rubber oil pan gasket)	17457.03

14 TIMING COVER GASKET SETS WITH OIL SEALS

DESCRIPTION	PART #
1965-90 6 CYLINDER 232, 258	17449.01
1971-93 V8 (all)	17449.02

VALVETRAIN

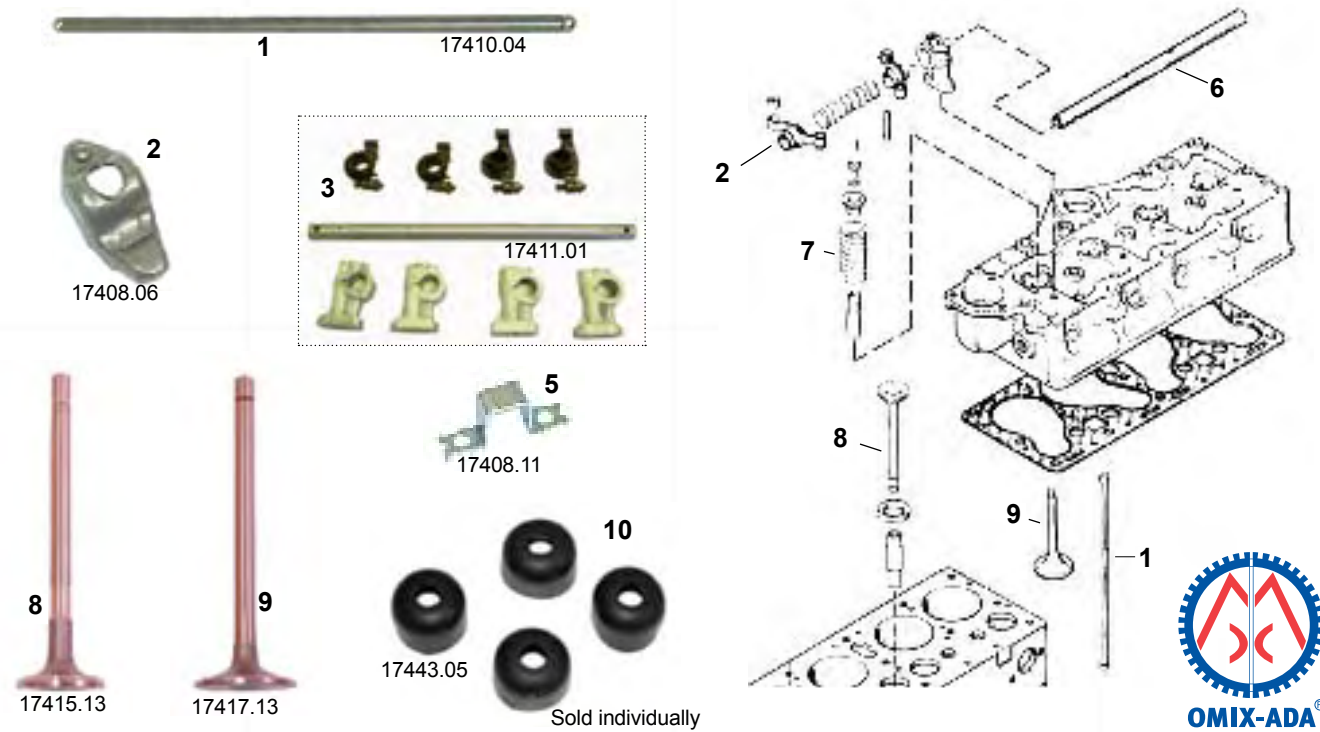

1 PUSH RODS

DESCRIPTION	PART #
1984-02 4 CYLINDER 2.5L	17410.01
1972-77 6 CYLINDER 232 OR 258, (temp. sending unit in front of cylinder head)	17410.02
1977-80 6 CYLINDER 258, (1977 models with temp. sending unit in rear of head)	17410.03
1981-90 6 CYLINDER 258 (4.2L)	17410.04
1972-91 V8 AMC	17410.06

2 ROCKER ARMS

DESCRIPTION	PART #
1953-71 4 CYL F-HEAD ROCKER ARM LEFT (each)	17408.03
CJ3B, CJ5, CJ6, M38A1	
1953-71 4 CYL F-HEAD ROCKER ARM RIGHT (each)	17408.04
CJ3B, CJ5, CJ6, M38A1	
1983-02 4 CYLINDER 2.5L, ROCKER ARM	17408.06
1974-82 6 CYLINDER 232 OR 258, ROCKER ARM	17408.07
1983-90 6 CYLINDER 258 (4.2L), ROCKER ARM	17408.06
1987-04 6 CYLINDER 4.0L, ROCKER ARM	17408.06
1972-91 V8 AMC, ROCKER ARM	17408.14

3 ROCKER ARM KITS

DESCRIPTION	PART #
*1953-71 4 CYL F-HEAD UNASSEMBLED VALVE ROCKER KIT: CJ3B, CJ5, CJ6, M38A1 (includes 2 left arms, 2 right arms, 4 brackets & 1 shaft)	17411.01
1974-82 6 CYL 232 OR 258 (4.2L), ROCKER ARM KIT (2 arms & 2 pivots & 1 bridge)	17411.02
1983-90 6 CYL 4.2L, ROCKER ARM KIT (2 arms & 2 pivots & 1 bridge without stud)	17411.03
1983-90 6 CYL 4.2L, ROCKER ARM KIT (2 arms & 2 pivots & 1 bridge with stud)	17411.04
1972-91 V8 AMC, ROCKER ARM KIT (2 arms & 2 pivots & 1 bridge)	17411.05

4 ROCKER ARM PIVOTS

DESCRIPTION	PART #
1983-02 4 CYLINDER 2.5L	17408.10
1981-90 6 CYLINDER 4.2L	17408.10
1987-04 6 CYLINDER 4.0L	17408.10
1972-91 V8 AMC	17408.10
1972-79 6 CYLINDER CJ	17408.13

5 ROCKER ARM BRIDGES

DESCRIPTION	PART #
1983-96 4 CYLINDER 2.5L	17408.11
1983-90 6 CYLINDER 4.2L (without stud)	17408.11
1983-90 6 CYLINDER 4.2L (with stud)	17408.12
NEED 2 W/ PLASTIC VALVE COVER	17408.11
1987-96 6 CYLINDER 4.0L	17408.11
1972-91 V8 AMC	17408.11

6 ROCKER ARM SHAFTS & BRACKETS

DESCRIPTION	PART #
1953-71 4 CYL F-HEAD ROCKER ARM BRACKET (each)	17408.02
CJ3B, CJ5, CJ6, M38A1	
1953-71 4 CYL F-HEAD ROCKER ARM SHAFT (each)	17408.05
CJ3B, CJ5, CJ6, M38A1	
1968-74 6 CYL AMC 232 OR 258, ROCKER ARM SHAFT	17408.09

7 VALVE SPRINGS

DESCRIPTION	PART #
VALVE SPRING, INTAKE (L-head), EXHAUST (L-head AND F-head)	17409.01
VALVE SPRING, INTAKE, F-HEAD 4 CYL 134 ENGINE	17409.02

8 EXHAUST VALVES & GUIDES (SOLD SEPARATELY, NOT A SET)

DESCRIPTION	PART #
1941-53 4 CYLINDER L-HEAD	17415.01
1941-71 4 CYL L-HEAD & F-HEAD EXH. VALVE GUIDE	17416.01
1948-63 6 CYLINDER 226	17415.13
1952-71 4 CYLINDER F-HEAD	17415.02
1966-71 V6 225, 1.375" DIAMETER	17415.14
1973-80 6 CYLINDER 232, 258 OR V8 304 (standard)	17415.05
1973-80 6 CYLINDER 232, 258 OR V8 304, .003 OVER	17415.06
1973-80 6 CYLINDER 232, 258 OR V8 304, .015 OVER	17415.07
1975-93 V8 360, 401 STD.	17415.11
1981-90 6 CYLINDER 258 OR V8 304 (standard)	17415.08
1981-90 6 CYLINDER 258 OR V8 304, .003 OVER	17415.09
1981-90 6 CYLINDER 258 OR V8 304, .015 OVER	17415.10
1987-99 4 CYLINDER 2.5L, .015 OVER	17415.04
1987-99 4 CYLINDER 2.5L, STANDARD	17415.03
1987-99 6 CYLINDER 4.0L, .015 OVER	17415.04
1987-99 6 CYLINDER 4.0L, STANDARD	17415.03
1993-98 V8 5.2L GRAND CHEROKEE (standard)	17415.12

9 INTAKE VALVES & GUIDES (SOLD SEPARATELY, NOT A SET)

DESCRIPTION	PART #
1941-53 4 CYLINDER L-HEAD	17417.01
1941-53 4 CYLINDER L-HEAD VALVE GUIDE	17416.02
1948-63 6 CYLINDER 226	17417.13
1952-71 4 CYLINDER F-HEAD	17417.02
1952-71 4 CYLINDER F-HEAD VALVE GUIDE	17416.03
1973-80 6 CYLINDER 232, 258 OR V8 304 (standard)	17417.05
1973-80 6 CYLINDER 232, 258 OR V8 304, .003 OVER	17417.06
1973-80 6 CYLINDER 232, 258 OR V8 304, .015 OVER	17417.07
1981-90 6 CYLINDER 258 OR V8 304 (standard)	17417.08
1981-90 6 CYLINDER 258 OR V8 304, .003 OVER	17417.09
1981-90 6 CYLINDER 258 OR V8 304, .015 OVER	17417.10
1975-93 V8 360, 401 (standard)	17417.11
1987-99 4 CYLINDER 2.5L (standard)	17417.03
1987-99 4 CYLINDER 2.5L, .015 OVER	17417.04
1987-99 6 CYLINDER 4.0L (standard)	17417.03
1987-99 6 CYLINDER 4.0L, .015 OVER	17417.04
1993-98 V8 5.2L GRAND CHEROKEE (standard)	17417.12
2002-06 V6 3.7L	17417.19

10 VALVE STEM SEALS (EACH)

DESCRIPTION	PART #
1968-90 6 CYL AMC 199, 232, 258 (both exhaust & intake)	17443.05
1971-91 V8 AMC 304, 360, 401 (both exhaust & intake)	17443.05
1983-85 4 CYLINDER 2.5L (both exhaust & intake)	17443.01
1987-93 4 CYLINDER 2.5L EXHAUST	17443.02
1987-93 4 CYLINDER 2.5L INTAKE	17443.03
1987-93 6 CYLINDER 4.0L EXHAUST	17443.02
1987-93 6 CYLINDER 4.0L INTAKE	17443.03
1993-98 8 CYLINDER 5.2L/5.9L EXHAUST	17443.04
1994-02 4 CYLINDER 2.5L EXHAUST	17443.04
1994-06 6 CYLINDER 4.0L EXHAUST	17443.04

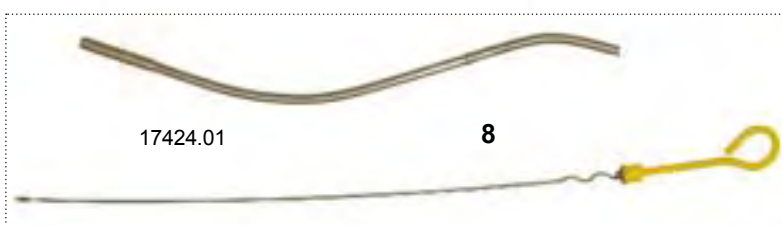
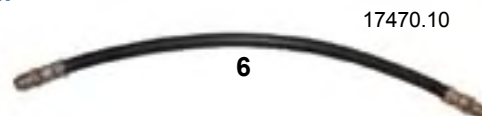

1 OIL PUMPS

DESCRIPTION	PART #
1941-45 MB 4 CYLINDER	17433.01
1945-47 CJ2A 4 CYLINDER	17433.01
1947-71 CJ 4 CYLINDER 134	17433.02
1983-02 2.5L	17433.03
1948-63 6 CYLINDER 226	17433.04
1965-80 6 CYLINDER 232 OR 258 WITHOUT SCREEN	17433.05
1965-80 SCREEN FOR ABOVE OIL PUMP	17433.06
1965-80 OIL PUMP WITH SCREEN	17433.07
1981-90 4.2L WITHOUT SCREEN	17433.03
1987-06 4.0L	17433.03
1981-90 6 CYLINDER 258 ENG. SCREEN	17433.08
1981-90 6 CYLINDER 258 ENG. OIL PUMP W/ SCREEN	17433.09
1968-90 6 CYLINDER AMC 199, 232 OR 258 HI VOLUME OIL PUMP WITH SCREEN	17433.10
1971-93 V8 OIL PUMP REPAIR KIT	17433.11
1971-93 V8 AMC, OIL PUMP SCREEN ONLY	17433.12

2 OIL FILTERS

DESCRIPTION	PART #
1941-45 MB (drop in)	17436.01
1941-68 4 CYL 134 L-HEAD ENGINE OIL FILTER BRACKET	17435.01
1945-49 CJ2A (drop in)	17436.01
1950-52 M38 (drop in)	17436.01
1952-71 M38A1 (drop in)	17436.01
1956-67 CIVILIAN 4-134 (drop in)	17436.02
1956-67 CJ 4 CYL F-HEAD OIL FILTER CARTRIDGE ASSY.	17436.03
1959-63 6 CYLINDER 226 (late)	17436.14
1964-71 4 CYL 134 ENGINE, OIL FILTER COVER	17436.05
1964-71 4 CYLINDER 134 F-HEAD ENGINE	17436.04
1980-86 4 CYLINDER	17436.06
1987-90 4 CYLINDER	17436.07
1987-96 4 CYLINDER EXPORT	17436.07
1991-02 4 CYLINDER	17436.08
2002-06 2.4L LIBERTY	17436.09
2003-06 2.4L 4 CYLINDER WRANGLER	17436.09
1966-73 6 CYLINDER CJ	17436.10
1981-86 6 CYLINDER	17436.12
1987-90 6 CYLINDER 4.0L OR 4.2L	17436.07
1991-06 6 CYLINDER 4.0L	17436.08
1984-86 V6	17436.06
2002-07 3.7L V6 LIBERTY	17436.13
2007-10 3.8L V6 WRANGLER	17436.09
1999-03 3.1L V6 DIESEL ENGINE (export markets)	17436.15
1972-83 V8	17436.11
1974-80 V8	17436.11
1993-98 V8 GRAND CHEROKEE (5.2L, 5.9L, 4.7L)	17436.08
1999-07 V8 GRAND CHEROKEE (5.2L, 5.9L, 4.7L)	17436.08

3 OIL PANS

DESCRIPTION	PART #
1968-90 6 CYLINDER AMC 199, 232, 258 (4.2L)	17437.01
1987-06 6 CYLINDER 4.0L	17437.02

4 OIL PAN GASKETS

DESCRIPTION	PART #
1941-71 4 CYLINDER 134	17439.01
1966-71 V6 225 (NEW)	17439.08
1983-96 4 CYLINDER 2.5L	17439.02
1991-96 4 CYLINDER 2.5L	17439.03
1996-02 4 CYLINDER 2.5L (molded rubber)	17439.04
1968-90 6 CYLINDER 232 OR 258	17439.05
1968-90 6 CYLINDER 232 OR 258 (1pc molded rubber)	17439.06
1987-04 6 CYLINDER 4.0L	17439.06
2002-07 6 CYLINDER 3.7L	17439.10
1970-93 8 CYLINDER 304, 360 OR 401	17439.07
1999-06 V8 4.7L (NEW)	17439.09

5 OIL PAN DRAIN PLUGS

DESCRIPTION	PART #
1941-71 4 CYLINDER 134 ENGINE	17438.01
1941-71 4 CYL 134 ENGINE, DRAIN PLUG GASKET	17438.02
1968-90 6 CYLINDER 4.2L	17438.03
1992-04 4.0L 6 CYLINDER WRANGLER	17438.04
1992-01 4.0L 6 CYLINDER CHEROKEE	17438.04
1993-98 4.0L 6 CYLINDER GRAND CHEROKEE	17438.04
1999-04 4.0L 6 CYLINDER GRAND CHEROKEE	17438.04
2002-05 2.4L 4 CYLINDER LIBERTY	17438.04
2003-05 2.4L 4 CYLINDER WRANGLER	17438.04

6 ENGINE OIL LINES

DESCRIPTION	PART #
1941-53 4 CYLINDER 134 L-HEAD MB LONG (inlet)	17470.06
1945-71 4 CYLINDER 134 L-HEAD CJ LONG (inlet)	17470.06
1941-53 4 CYLINDER 134 L-HEAD MB SHORT (outlet)	17470.07
1945-71 4 CYLINDER 134 L-HEAD CJ SHORT (outlet)	17470.07
1952-71 4 CYLINDER 134 F-HEAD CJ 23" LONG (inlet)	17470.08
1952-71 4 CYLINDER 134 F-HEAD CJ 30.5" LONG (inlet)	17470.09
1952-71 4 CYLINDER 134 F-HEAD CJ OUTLET	17470.10

7 OIL CAPS

DESCRIPTION	PART #
1971-91 V8 AMC	17403.04
1974-80 6 CYLINDER AMC 232 OR 258	17403.01
1980-82 4 CYLINDER GM 151	17403.01
1981-90 6 CYLINDER 4.2L OR 4.0L	17403.02
1983-93 4 CYLINDER AMC 2.5L	17403.02
1994-98 V8 GRAND CHEROKEE	17403.03
1996-02 ALL 4.0L	17403.03

8 OIL DIP STICKS

DESCRIPTION	PART #
1972-83 AMC V8, OIL DIPSTICK & TUBE	17424.01
1972-83 AMC V8, DIP STICK TUBE, ENGINE OIL	17424.02
1972-83 AMC V8, DIP STICK, ENGINE OIL	17424.03

FLYWHEEL & MOUNTS



16911.02

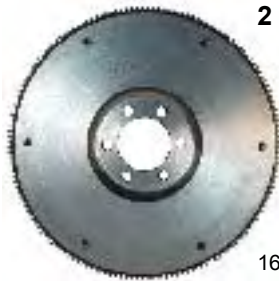

2

16912.05



3

16913.05

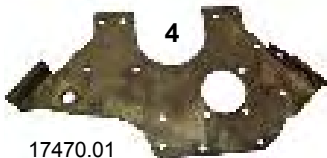

17470.01



OMIX-ADA®



17474.01



5

17472.02



6

17473.05



5

17472.05

1 FLYWHEEL RING GEARS

DESCRIPTION	PART #
1941-49 4 CYLINDER MB	16911.01
1945-49 4 CYLINDER CJ2A	16911.01
1953-71 4 CYLINDER 134	16911.02
1965-71 6 CYLINDER 232	16911.05
1967-71 V6 225	16911.04
1972-92 V8 AMC	16911.06
1972-98 6 CYLINDER 232, 258 (4.2L), 242 (4.0L)	16911.06
1983-96 4 CYLINDER 2.5L	16911.03

5 1974-81 V8 CJ ENGINE MOUNT BRACKETS

DESCRIPTION	PART #
LOWER LEFT	17472.01
LOWER RIGHT	17472.02
UPPER LEFT	17472.03
UPPER RIGHT	17472.04
BRACKET KIT: 4 BRACKETS & 2 MOUNTS	17472.05

2 FLYWHEELS, MANUAL TRANSMISSION

DESCRIPTION	PART #
1972-79 6 CYLINDER 232 OR 258	16912.03
1972-79 AMC V8 401	16912.09
1972-86 CJ WITH GM V8 CONVERSION, 168 TOOTH	16912.10
1972-91 AMC V8 360	16912.08
1982-87 4.2L	16912.05
1988-90 4.2L WRANGLER	16912.06
1991-95 2.5L ALL - Also fits (TJ) 97-02 2.5L	16912.02
1991-95 4.0L ALL	16912.07

6 ENGINE MOUNTS

DESCRIPTION	PART #
1941-71 4 CYLINDER ALL	17473.01
1984-90 4 CYLINDER CHEROKEE RIGHT	17473.02
1984-93 4 CYLINDER CHEROKEE LEFT	17473.03
1987-90 4 CYLINDER WRANGLER, LH OR RH	17473.03
1991-00 4 CYLINDER 2.5L CHEROKEE	17473.03
1991-96 4 CYLINDER WRANGLER, LEFT	17473.03
1997-02 4 CYLINDER 2.5L WRANGLER	17473.04
2003-06 4 CYLINDER 2.4L WRANGLER	17473.04
1948-63 6 CYLINDER 226	17473.05
1964-76 6 CYLINDER 232 OR 258	17473.06
1978-86 6 CYL 232 OR 258 BLACK POLY(pair)	17473.09
1978-86 6 CYL 232 OR 258 RED POLY(pair)	17473.08
1978-86 6 CYLINDER 232 OR 258	17473.07
1987-01 6 CYLINDER 4.0L CHEROKEE, BLACK POLY (pair)	17473.15
1987-01 6 CYLINDER 4.0L CHEROKEE, RED POLY (pair)	17473.14
1987-01 6 CYLINDER 4.0L WRANGLER, BLACK POLY (pair)	17473.15
1987-01 6 CYLINDER 4.0L WRANGLER, RED POLY (pair)	17473.14
1987-96 6 CYLINDER CHEROKEE 4.2L OR 4.0L	17473.10
1987-96 6 CYLINDER WRANGLER	17473.10
1993-98 6 CYLINDER 4.0L GRAND CHEROKEE, LH	17473.13
1993-98 6 CYLINDER 4.0L GRAND CHEROKEE, RH	17473.12
1997-05 6 CYLINDER 4.0L WRANGLER	17473.11
1967-92 V8 AMC, POLY, BLACK (pair)	17473.18
1967-92 V8 AMC, POLY, RED (pair)	17473.17
1974-91 V8 304, 360, 401	17473.16
1993-98 V8 GRAND CHEROKEE, LH	17473.19
1993-98 V8 GRAND CHEROKEE, RH	17473.20
1999-04 V8 4.7L GRAND CHEROKEE, LH	17473.21
1999-04 V8 4.7L GRAND CHEROKEE, RH	17473.22

3 FLEX PLATES, AUTOMATIC TRANSMISSION

DESCRIPTION	PART #
1972-86 CJ WITH GM V8 CONVERSION, 168 TEETH	16913.08
1976-79 6 CYLINDER 258	16913.01
1976-79 8 CYLINDER 304	16913.02
1976-79 V8 360	16913.03
1976-79 V8 401	16913.04
1980-86 V8 258	16913.05
1980-86 V8 304, 360	16913.06
1987-90 4.0L CHEROKEE	16913.11
1988-93 V8	16913.09
1991-00 4.0 CHEROKEE FLEX PLATE - Also fits (YJ) 91-95 4.0L	16913.10
DJ POSTAL JEEP APPLICATIONS	16913.07

4 MISC. ENGINE ITEMS

DESCRIPTION	PART #
1941-1948 MB & EARLY CJ2A WITH TIMING CHAIN ENGINE MOUNT PLATE	17470.01
1941-71 4 CYL 134, CAMSHAFT THRUST PLATE	17470.03
1941-71 4 CYL 134 ENGINE, GENERATOR BUSHING	17470.04
1941-71 4 CYL 134 ENGINE, GENERATOR BOLT	17470.05
1941-71 4 CYL 134 ENGINE DRAIN COCK	17470.11

7 DRIVETRAIN MOUNT KITS

(ENGINE, TRANSMISSION & TRANSFER CASE)	DESCRIPTION	PART #
	1941-71 4 CYLINDER 134	17474.01
	1974-83 V8 CJ	17474.05
	1974-86 6 CYLINDER 258	17474.03
	1987-90 4 CYLINDER WRANGLER	17474.02
	1987-96 6 CYLINDER WRANGLER	17474.04

HEADERS & MANIFOLDS



17660.01



17650.01



17650.51



17660.02



17650.02



17650.52



17624.09



17622.01

RUGGED RIDGE EXHAUST HEADERS

The new **Exhaust Headers** for 1991-06 4.0L motors are sure to increase performance and horsepower. These headers are a great upgrade to any stock 4.0L engine. The complete bolt on kit includes manifold, gasket, hardware and down pipe flange gasket (where necessary). Available in Standard Steel with a 700-degree high temp black coating, 409 or 304 grade Stainless Steel for long lasting durability, rust resistance and performance life.

1 STANDARD STEEL (Black)

DESCRIPTION	PART #
1991-98 4.0L WRANGLER (UPGRADE)	17660.01
2000-06 4.0L WRANGLER (UPGRADE)	17660.02
1991-98 4.0L CHEROKEE (UPGRADE)	17660.01
1993-98 4.0L GRAND CHEROKEE (UPGRADE)	17660.01
2000-06 4.0L GRAND CHEROKEE (UPGRADE)	17660.02

2 409 STAINLESS STEEL

DESCRIPTION	PART #
1991-98 4.0L WRANGLER (UPGRADE)	17650.01
2000-06 4.0L WRANGLER (UPGRADE)	17650.01
1991-98 4.0L CHEROKEE (UPGRADE)	17650.01
1993-98 4.0L GRAND CHEROKEE (UPGRADE)	17650.01
2000-06 4.0L GRAND CHEROKEE (UPGRADE)	17650.01

3 304 STAINLESS STEEL (Polished)

DESCRIPTION	PART #
1991-98 4.0L WRANGLER (UPGRADE)	17650.51
2000-06 4.0L WRANGLER (UPGRADE)	17650.52
1991-98 4.0L CHEROKEE (UPGRADE)	17650.51
1993-98 4.0L GRAND CHEROKEE (UPGRADE)	17650.51
2000-06 4.0L GRAND CHEROKEE (UPGRADE)	17650.52

4 Ceramic

DESCRIPTION	PART #
1991-98 4.0L WRANGLER (UPGRADE)	17651.01
2000-06 4.0L WRANGLER (UPGRADE)	17651.02

4 EXHAUST MANIFOLD KITS WITH GASKETS

DESCRIPTION	PART #
1941-68 4 CYL 134 L-HEAD (will not fit F-head)	17622.01
1984-90 4 CYLINDER 150 AMC 2.5L, WITH GASKET	17622.03
1991-00 4 CYLINDER 2.5L WITH GASKET	17622.04
1968-80 6 CYLINDER 199, 232 OR 258, WITH GASKET	17622.05
1981-90 6 CYLINDER 258 WITH GASKET	17622.06
1987-90 6 CYLINDER 4.0L, WITH GASKET	17622.07
1991-98 6 CYLINDER 4.0L, WITH GASKET	17622.08
1971-91 AMC V8 RH, WITH GASKET	17622.10
1971-91 AMC V8 LH, WITH GASKET	17622.09

5 EXHAUST MANIFOLDS

DESCRIPTION	PART #
1941-68 4 CYL 134 L-HEAD (will not fit F-head)	17624.01
1941-68 4 CYL 134 L-HEAD SPARE HARDWARE KIT	17625.01
1953-71 4 CYL 134 F-HEAD	17624.02
1941-68 4 CYL 134 L-HEAD BITMETAL EXHAUST MANIFOLD SPRING (NEW)	17625.02
1984-90 4 CYL 2.5L AMC	17624.03
1984-90 4 CYL 2.5L AMC, CAST-IRON	17624.04
1991-02 4 CYL 2.5L	17624.05
1968-80 6 CYL 199, 232 OR 258	17624.06
1981-90 6 CYL 258	17624.07
1987-90 6 CYL 4.0L	17624.08
1991-99 6 CYL 4.0L	17624.09
1999-04 GRAND CHEROKEE 4.0L 6 CYL, REAR	17624.11
1999-04 GRAND CHEROKEE 4.0L 6 CYL, FRONT	17624.10
2000-06 WRANGLER 4.0L 6 CYL, FRONT	17624.10
2000-01 CHEROKEE 4.0L 6 CYL, FRONT	17624.10
2000-06 WRANGLER 4.0L 6 CYL, REAR	17624.11
2000-01 CHEROKEE 4.0L 6 CYL, REAR	17624.11
1970-91 V8 AMC, LH (driver side)	17624.13
1971-91 V8 AMC, RH (passenger side)	17624.12
1999-04 GRAND CHEROKEE V8 4.7L, LH	17624.15
1999-04 GRAND CHEROKEE V8 4.7L, RH	17624.14

EXHAUST



1 EXHAUST & INTAKE MANIFOLD GASKET SETS

DESCRIPTION	PART #
1941-53 4 CYLINDER L-HEAD	17451.01
1952-71 4 CYLINDER F-HEAD	17451.02
1966-71 6 CYLINDER 225, EXHAUST (NEW)	17450.10
1984-90 4 CYLINDER 2.5L	17451.10
2002-06 4 CYL 2.4L LIBERTY	17451.12
2003-06 4 CYL 2.4L WRANGLER	17451.12
1965-80 6 CYLINDER 232 OR 258	17451.03
1981-90 6 CYLINDER 258	17451.04
1987-90 6 CYLINDER 4.0L	17451.05
1991-96 6 CYLINDER 4.0L	17451.06
CYLINDER 4.0L CHEROKEE	17451.11
2000-06 6 CYLINDER 4.0L WRANGLER	17451.11
2002-06 6 CYLINDER 3.7L, LH SIDE	17451.14
2002-06 6 CYLINDER 3.7L, RH SIDE	17451.13
1971-93 8 CYLINDER EXHAUST (all)	17451.08
1971-93 8 CYLINDER INTAKE (all)	17451.07
1999-06 8 CYLINDER 4.7L, EXHAUST (NEW)	17450.12

2 EXHAUST PIPE GASKETS

DESCRIPTION	PART #
1946-71 4 CYLINDER 134	17450.01
1968-90 6 CYLINDER AMC 199, 232, 258	17450.02
1971-91 V8 AMC 304, 360, 401	17450.03
1991-00 6 CYLINDER 4.0L WRANGLER, EXHAUST PIPE TO MANIFOLD	17450.04
1987-95 4 OR 6 CYLINDER (2.5L, 4.2L, 4.0L) WRANGLER FRONT PIPE TO CONVERTER	17617.05

3 FRONT PIPES

DESCRIPTION	PART #
1946-71 4 CYLINDER 134 CJ	17613.01
1972-78 6 CYLINDER CJ5	17613.05
1976-78 6 CYLINDER CJ7	17613.06
1983-86 6 CYLINDER CJ7 & CJ8	17613.07
1976-78 V8 304 CJ7 WITH 3 SPEED TRANS	17613.12
1987-92 4 CYLINDER 2.5L WRANGLER	17613.02
1993-95 4 CYLINDER WRANGLER 2.5L	17613.19
1987-90 6 CYLINDER 4.2L WRANGLER	17613.08
1991-92 6 CYLINDER 4.0L WRANGLER	17613.09
1984-86 4 CYLINDER 2.5L CHEROKEE	17613.03
1987-92 4 CYLINDER 2.5L CHEROKEE	17613.04
1993-95 4 CYLINDER CHEROKEE 2.5L	17613.16
1987-90 6 CYLINDER 4.0L CHEROKEE	17613.10
1991-92 6 CYLINDER 4.0L CHEROKEE	17613.11
1993-95 6 CYLINDER CHEROKEE 4.0L	17613.17
1996-98 6 CYLINDER CHEROKEE 4.0L	17613.18
1984-86 V6 CHEROKEE 2.8L	17613.15
1993-95 V8 GRAND CHEROKEE	17613.13
1996-98 V8 GRAND CHEROKEE 5.2L, 5.9L	17613.20

4 EXHAUST Kit

DESCRIPTION	PART #
EXHAUST KIT, 134 CI, JEEP C.J2A 46-49, C.J3A 49-53, C.J3B 53-64, C.J5 55-71, C.J6 55-71 (NEW)	17606.11

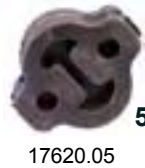

1 CATALYTIC CONVERTER KITS (INCLUDES HARDWARE)

DESCRIPTION	PART #
1984-86 4 CYLINDER 2.5L CJ *	17601.01
1975-78 6 & 8 CYLINDER CJ	17601.04
1981-86 6 CYLINDER 4.2L CJ *	17601.01
1987-92 4 CYLINDER 2.5L WRANGLER	17601.02
1993-95 4 CYLINDER 2.5L WRANGLER	17601.03
1987-90 6 CYLINDER 4.2L WRANGLER *	17601.05
1991-92 6 CYLINDER 4.0L WRANGLER	17601.02
1993-95 6 CYLINDER 4.0L WRANGLER	17601.03
* AIR TUBE CONVERSION KIT	
MUST BE USED W/ 17601.01 & 17601.05	17603.01

2 CATALYTIC CONVERTERS

DESCRIPTION	PART #
1984-86 4 CYLINDER 2.5L CJ	17604.01
1975-78 6 CYLINDER & V8 CJ	17604.05
1979-83 CJ5/7/8 4.2L, GM 151 W/O AIR TUBE	17604.11
1981-86 6 CYLINDER 4.2L CJ WITH AIR TAP *	17604.01
1987-92 4 CYLINDER 2.5L WRANGLER	17604.03
1993-95 4 CYLINDER 2.5L WRANGLER	17604.04
1993-96 4 CYLINDER 2.5L WRANGLER	17604.04
1997-00 2.5L & 4.0L WRANGLER	17604.10
1987-90 6 CYLINDER 4.2L WRANGLER WITH AIR TAP *	17604.02
1991-92 6 CYLINDER 4.0L WRANGLER	17604.03
1993-95 6 CYLINDER 4.0L WRANGLER	17604.04
1984-85 4 CYLINDER 2.5L CHEROKEE	17604.02
1993-95 4 CYLINDER 2.5L CHEROKEE	17604.04
1996-00 4 CYLINDER 2.5L CHEROKEE	17604.08
1991-92 6 CYLINDER 4.0L CHEROKEE	17604.03
1993-95 6 CYLINDER 4.0L CHEROKEE	17604.04
1996-01 6 CYLINDER 4.0L CHEROKEE	17604.08
1984-86 CHEROKEE V6 2.8L	17604.12
1993-95 6 CYLINDER 4.0L GRAND CHEROKEE	17604.04
1996-01 6 CYLINDER 4.0L GRAND CHEROKEE	17604.08
1994-95 V8 GRAND CHEROKEE	17604.07
1996-98 V8 GRAND CHEROKEE	17604.08
1999-01 4.7L V8 GRAND CHEROKEE	17604.08
1981-86 6 CYLINDER 4.2L SJ WITH AIR TAP *	17604.01
1974-91 V8 SJ	17604.06
* AIR TUBE CONVERSION KIT	
MUST BE USED W/ 17604.01 & 17604.02	17603.01

3 INTERMEDIATE PIPE

DESCRIPTION	PART #
1946-71 4 CYLINDER 134 CJ	17608.01
1981 CJ8	17608.02
2000-01 6 CYLINDER 4.0L CHEROKEE	17608.03

4 CAT BACK EXHAUST KITS (INCLUDES MUFFLER, TAILPIPE, CLAMPS & HARDWARE)

DESCRIPTION	PART #
1987-92 4 CYLINDER 2.5L WRANGLER (UPGRADE)	17606.01
1993-95 4 CYLINDER 2.5L WRANGLER (UPGRADE)	17606.02
1972-75 6 CYLINDER OR V8 CJ5 (UPGRADE)	17606.03
1976-78 6 CYLINDER CJ5, CJ7 (UPGRADE)	17606.04
1979-81 6 CYL CJ5 & CJ7 W/ CONVERTER (UPGRADE)	17606.05
1981 6 CYLINDER CJ8 (UPGRADE)	17606.06
1983-86 6 CYLINDER CJ7 (UPGRADE)	17606.07
1983-85 6 CYLINDER CJ8 (UPGRADE)	17606.06
1987-90 6 CYLINDER 4.2L WRANGLER (UPGRADE)	17606.09
1991-92 6 CYLINDER 4.0L WRANGLER (UPGRADE)	17606.01
1993-95 6 CYLINDER 4.0L WRANGLER (UPGRADE)	17606.02
1976-81 V8 304 CJ5, CJ7 (UPGRADE)	17606.10

See the Page 92 for a selection of performance cat back exhaust system designed for hard off road use.

5 EXHAUST HANGERS & INSULATORS

DESCRIPTION	PART #
HANGER SWIVEL TYPE	17620.01
HANGER	17620.02
BRACKET	17620.03
INSULATOR	17620.04
INSULATOR	17620.05

EXHAUST

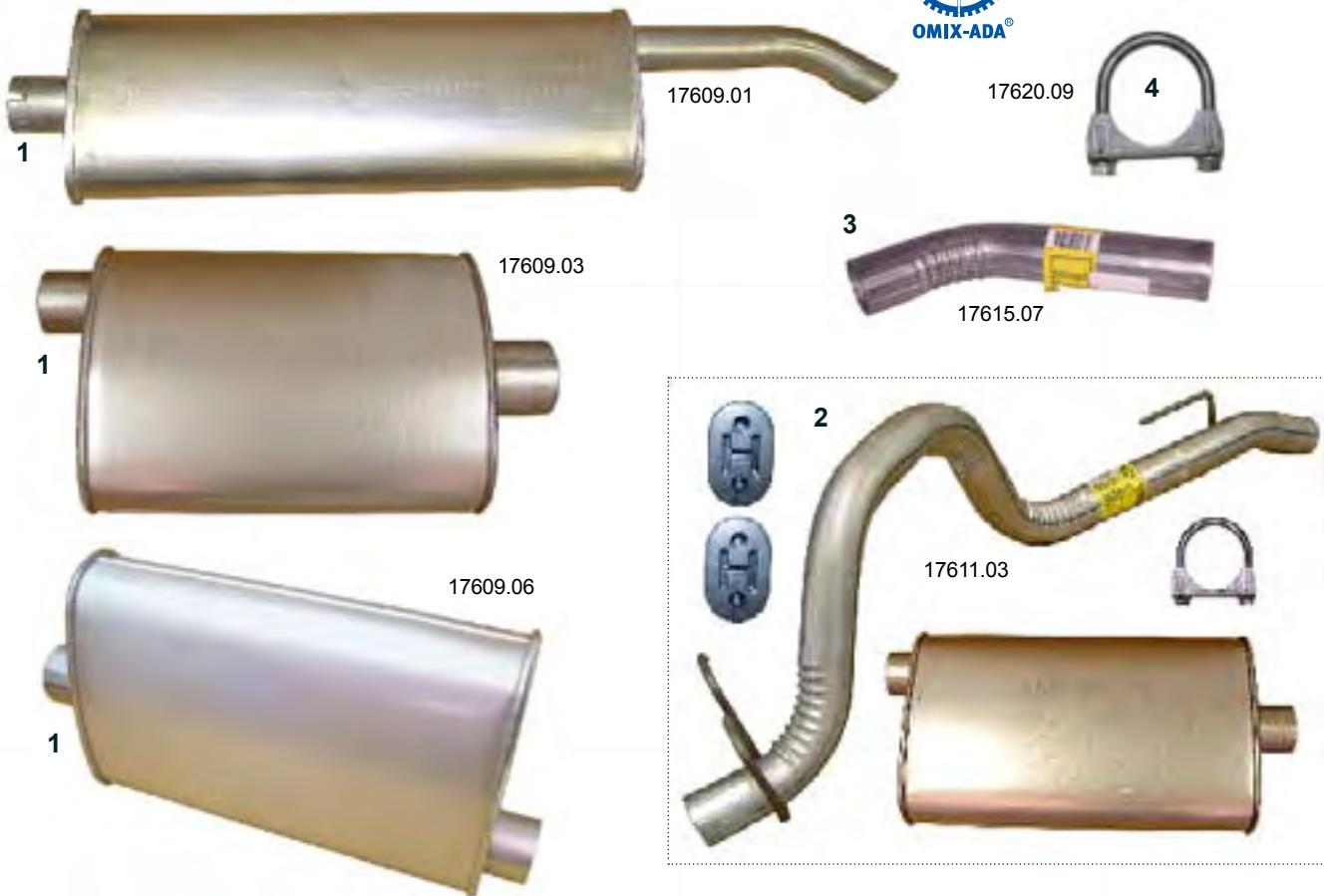

1 REPLACEMENT MUFFLERS

DESCRIPTION	PART #
1941-45 4 CYLINDER MB & GPW, OVAL	17609.01
1946-71 4 CYLINDER 134 CJ, ROUND	17609.02
1980-83 4 CYLINDER 151 GM ENGINE CJ	17609.03
1983-86 4 CYLINDER 2.5L AMC ENGINE CJ	17609.04
1966-71 6 CYL V6 225 CJ	17609.09
1972-78 6 CYL CJ (models without converter)	17609.10
1976-82 6 CYL CJ (models with converter)	17609.03
1983-86 6 CYLINDER CJ	17609.04
1972-75 V8 CJ	17609.10
1976-81 V8 304 CJ	17609.03
1987-92 4 CYLINDER 2.5L WRANGLER	17609.05
1993-95 4 CYLINDER 2.5L WRANGLER	17609.06
1997-02 4 CYLINDER 2.5L WRANGLER	17609.17
1987-90 6 CYLINDER 4.2L WRANGLER	17609.16
1991-92 6 CYLINDER 4.0L WRANGLER	17609.05
1986-89 4 CYLINDER 2.5L CHEROKEE	17609.07
1993-95 4 CYLINDER 2.5L CHEROKEE	17609.08
1987-92 6 CYLINDER 4.0L CHEROKEE	17609.11
1993-95 6 CYLINDER 4.0L CHEROKEE	17609.08
1996-98 6 CYLINDER 4.0L CHEROKEE	17609.19
1986 V6 2.8L CHEROKEE	17609.12
1996-98 6 CYLINDER 4.0L GRAND CHEROKEE	17609.20
1993-95 V8 GRAND CHEROKEE	17609.15
1979-87 V8 J10 & J20 TRUCKS	17609.13
1981-91 V8 SJ CHEROKEE (except J10, J20)	17609.14

3 TAILPIPES

DESCRIPTION	PART #
1946-71 4 CYLINDER 134	17615.01
1980-81 4 CYLINDER 151 GM ENGINE CJ	17615.02
1983-86 4 CYLINDER 2.5L CJ (AMC engine)	17615.03
1972-75 6 CYLINDER CJ	17615.08
1976-78 6 CYLINDER CJ (models without converter)	17615.09
1976-81 6 CYLINDER CJ (models with converter)	17615.02
1983-86 6 CYLINDER CJ	17615.03
1966-71 V6 225 CJ	17615.07
1972-75 V8 CJ	17615.08
1976-81 V8 304 CJ	17615.02
1987-95 4 CYLINDER 2.5L WRANGLER	17615.04
1997-00 4 CYL 2.5L WRANGLER	17615.17
1987-90 6 CYLINDER 4.2L WRANGLER	17615.04
1991-95 6 CYLINDER 4.0L WRANGLER	17615.04
1997-00 6 CYL 4.0L WRANGLER	17615.17
1984-85 4 CYL 2.5L CHEROKEE	17615.12
1986-92 4 CYLINDER 2.5L CHEROKEE	17615.05
1993-96 4 CYLINDER 2.5L CHEROKEE	17615.06
1997-00 4 CYLINDER 2.5L CHEROKEE	17615.13
1987-92 6 CYLINDER 4.0 L CHEROKEE	17615.05
1993-96 6 CYLINDER 4.0L CHEROKEE	17615.06
1996-98 6 CYLINDER 4.0L CHEROKEE	17615.13
1984-86 V6 2.8L CHEROKEE	17615.12
1996-97 6 CYLINDER 4.0L GRAND CHEROKEE	17615.14
1993-95 6 CYLINDER 4.0L GRAND CHEROKEE	17615.10
1993-95 V8 GRAND CHEROKEE	17615.11
1996-98 V8 GRAND CHEROKEE	17615.15
1999-04 V8 4.7L GRAND CHEROKEE	17615.16

2 MUFFLER WITH TAILPIPE

DESCRIPTION	PART #
1993-95 4 CYLINDER 2.5L WRANGLER	17611.01
1991-92 6 CYLINDER 4.0L WRANGLER	17611.03
1993-95 6 CYLINDER 4.0L WRANGLER	17611.01
1993-95 4 CYLINDER 2.5L CHEROKEE	17611.02
1987-92 6 CYLINDER 4.0L CHEROKEE	17611.05
1993-95 6 CYLINDER 4.0L CHEROKEE	17611.02
1993-95 6 CYLINDER 4.0L GRAND CHEROKEE	17611.06

4 EXHAUST CLAMPS

DESCRIPTION	PART #
2" REGULAR DUTY	17620.06
2" HEAVY DUTY	17620.09
2-1/8" REGULAR DUTY	17620.07
2-1/4" REGULAR DUTY	17620.08
2-1/4" HEAVY DUTY	17620.10
2-1/4" STAINLESS STEEL	17620.13
2-1/2" HEAVY DUTY	17620.11
2-1/2" STAINLESS STEEL	17620.12

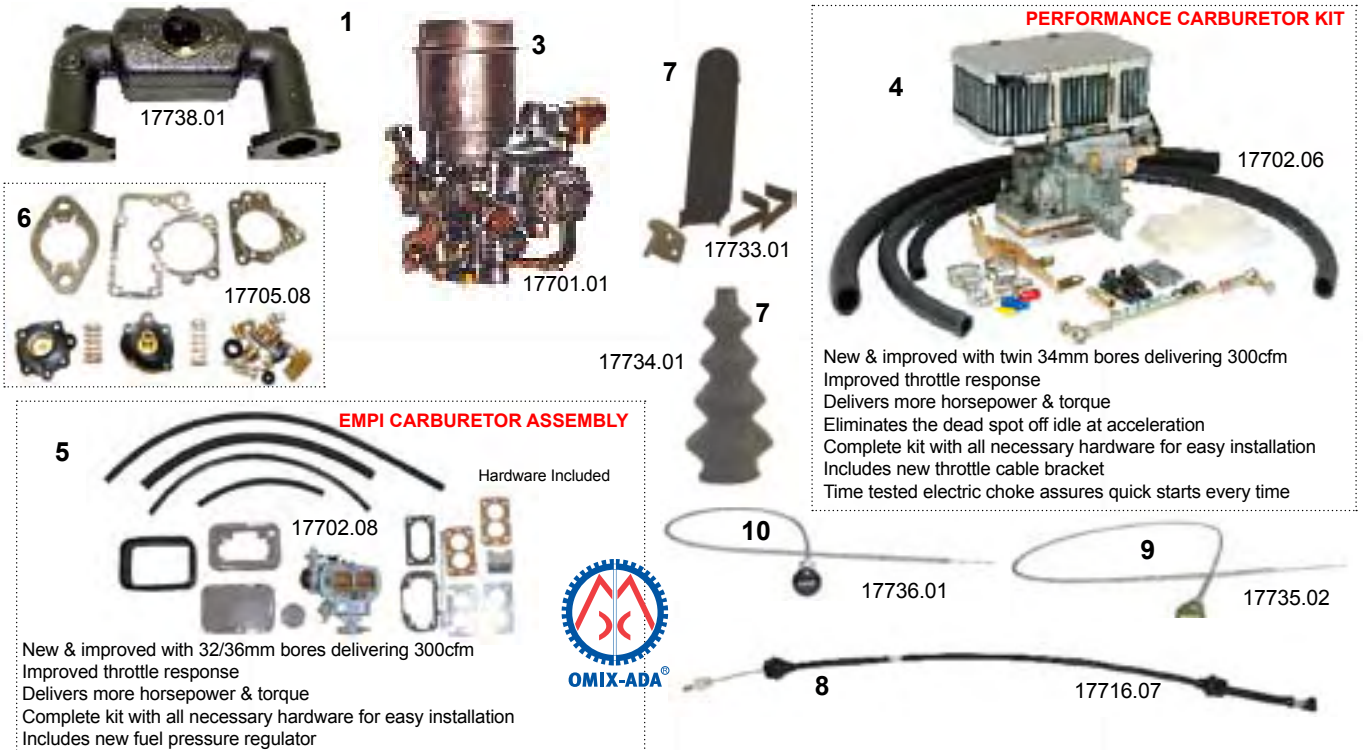

PERFORMANCE CARBURETOR KIT

17702.06

New & improved with twin 34mm bores delivering 300cfm
Improved throttle response
Delivers more horsepower & torque
Eliminates the dead spot off idle at acceleration
Complete kit with all necessary hardware for easy installation
Includes new throttle cable bracket
Time tested electric choke assures quick starts every time

EMPI CARBURETOR ASSEMBLY

17702.08

Hardware Included

New & improved with 32/36mm bores delivering 300cfm
Improved throttle response
Delivers more horsepower & torque
Complete kit with all necessary hardware for easy installation
Includes new fuel pressure regulator



1 INTAKE MANIFOLDS

DESCRIPTION	PART #
1941-45 4 CYL L-HEAD MB & GPW INTAKE MANIFOLD	17738.01
1945-49 4 CYL L-HEAD CJ2A INTAKE MANIFOLD	17738.01
1948-53 4 CYL L-HEAD CJ3A INTAKE MANIFOLD	17738.01
1953 4 CYL L-HEAD CJ3B INTAKE MANIFOLD	17738.01

2 INTAKE MANIFOLD GASKET SETS

DESCRIPTION	PART #
1966-71 V6 225 (NEW)	17445.01
1971-93 V8 ALL	17451.07
1999-06 V8 4.7L (NEW)	17445.03

3 CARBURETORS

DESCRIPTION	PART #
1941-45 MB & GPW, SOLEX DESIGN	17701.01
1946-49 CIVILIAN L-HEAD CJ2A, SOLEX DESIGN	17701.01
1948-53 CIVILIAN L-HEAD CJ3A, SOLEX DESIGN	17701.01
1955-65 CIVILIAN F-HEAD, CJ3B SOLEX DESIGN	17701.02
1955-71 CIVILIAN F-HEAD, CJ5 SOLEX DESIGN	17701.02
1955-71 CIVILIAN F-HEAD, CJ6 SOLEX DESIGN	17701.02

4 PERFORMANCE CARBURETOR CONVERSION KITS*

Kits Include:

Extra Large, High Life Air Filter, Stainless Steel Heat Shield & Hardware

DESCRIPTION	PART #
1945-71 CIVILIAN 4 CYLINDER, 32/36 DGV	17702.01
1980-83 4 CYL GM 151, 38mm PRIMARY/SECONDARY, REPLACES E-2SE ROCHESTER, REUSE OE AIR FILTER	17702.02
1980-83 4 CYL GM 151, 32/36mm PRIMARY/SECONDARY, REPLACES E-2SE ROCHESTER, UNIVERSAL AIR FILTER	17702.03
1983-86 4 CYLINDER CJ AMC 150, 300 CFM 32/36 DGEV	17702.04
1987-88 4 CYLINDER WRANGLER AMC 150, 300 CFM 32/36 DGEV	17702.04
1972-78 6 CYLINDER 232 OR 258 W/ CARTER 1 BARREL, 32/36 DGEV	17702.05
1972-90 6 CYLINDER 258 (4.2L) W/ CARTER 2 BARREL 300 CFM, 34/34 DGEV	17702.06
1972-90 6 CYLINDER 258 (4.2L) W/ CARTER 2 BARREL 400 CFM, 38 DEGS *	17702.07
1984-86 V6 CHEROKEE, REPLACES E-2SE ROCHESTER, 38 DEGREES	17702.02
1984-86 V6 CHEROKEE, REPLACES E-2SE ROCHESTER, 32/36 DEGREES	17702.03
REPAIR KIT FOR 17702.05, 17702.06, 17702.04	17703.01
REPAIR KIT FOR 17702.07	17703.02
SPARE ADAPTER FOR AIR FILTER	17704.01
ADAPTER FOR WEBER CARB AIR FILTER	17704.02
ADAPTER FOR WEBER AIR FILTER #17702.06	17704.03
FILTER FOR WEBER CARBURETOR (NEW)	17704.07
WEBER AIR CLEANER ASSEMBLY	17704.04
SPARE WEBER AIR FILTER	17704.05

*SOME KITS MAY NOT BE LEGAL IN ALL 50 STATES. CHECK LOCAL LAWS

5 EMPI CARBURETOR ASSEMBLY

DESCRIPTION	PART #
1972-90 6 CYL 258 (4.2L) W/ CARTER 2 BARREL 300 CFM, 32/36 DGEV, W/FUEL PRESSURE REGULATOR (this is not a direct Carter replacement)	17702.08

6 CARBURETOR REPAIR KITS

DESCRIPTION	PART #
REPAIR KIT FOR SOLEX DESIGN L-HEAD 17701.01	17705.01
REPAIR KIT FOR SOLEX DESIGN F-HEAD 17701.02	17705.02
1946-53 REPAIR KIT FOR CARTER L-HEAD CIVILIAN MB, CJ2A, CJ3A MASTER CARB REPAIR KIT WITH SPECIALTY MOUNTING GASKET	17705.03
MB, CJ2A, CJ3A GASKET WITH V-BRACKET	17705.04
1953-71 REPAIR KIT FOR CARTER F-HEAD CIVILIAN	17706.01
1953-71 F-HEAD WITH CARTER CARB, MASTER CARB REPAIR KIT	17705.05
M38 CARB REPAIR KIT	17705.06
M38A1 CARB REPAIR KIT	17705.07
1975-80 6 CYLINDER 1 BARREL CARTER 232, 258	17705.08
1976-86 6 CYLINDER 2 BARREL CARTER 232, 258	17705.09
	17705.10

7 ACCELERATOR PEDALS

DESCRIPTION	PART #
1941-45 MB	17733.01
1945-49 CJ2A	17733.01
1953 CJ3A	17733.01
1953-71 4 CYLINDER CJ	17733.02
1955-71 CJ5, DUST BOOT	17734.01
1955-71 CJ6, DUST BOOT	17734.01

8 ACCELERATOR CABLES

DESCRIPTION	PART #
1981-83 4 CYLINDER CJ, WITH GM 2.5L ENGINE	17716.01
1972-75 6 CYLINDER CJ, 27.75"	17716.04
1976-78 6 CYLINDER CJ, 30.5"	17716.05
1979-80 6 CYLINDER CJ & 1981-86 LHD EXPORT C.J.'S	17716.06
1981-86 6 CYLINDER CJ 24.25"	17716.07
1972-75 V8 CJ, 35-3/8"	17716.11
1976 V8 CJ, 21.25"	17716.12
1977-83 V8 CJ, 18.75"	17716.13
1987-90 4 CYLINDER WRANGLER, WITH CARB	17716.02
1987-90 4 CYLINDER WRANGLER, WITH FUEL INJ.	17716.03
1984-86 V6 CHEROKEE	17716.08
1987-90 6 CYLINDER CHEROKEE 4.0L	17716.09
1991-95 2.5L & 4.0L CHEROKEE	17716.15
1977-80 6 CYLINDER SJ	17716.10
1987-91 V8 SJ	17716.14
1976-95 WRANGLER THROTTLE CABLE BRACKET (NEW)	17737.20

9 THROTTLE CABLES

DESCRIPTION	PART #
1946-71 CJ, BLACK KNOB	17735.01
1941-45 MB, OLIVE GREEN KNOB	17735.02
1950-52 M38, OLIVE GREEN KNOB	17735.02
1952-71 M38A1, OLIVE GREEN KNOB	17735.02

10 CHOKE CABLES

DESCRIPTION	PART #
1946-71 CJ, BLACK KNOB	17736.01
1941-45 MB, OLIVE GREEN KNOB	17736.02
1950-52 M38, OLIVE GREEN KNOB	17736.02
1952-71 M38A1, OLIVE GREEN KNOB	17736.02

NOTICE

Performance or EMPI carburetor kit may affect or require readjustment of emissions equipped vehicles. Check emissions requirements before use on-road.

AIR CLEANERS



17737.09



17737.11



12021.58



12021.59



17737.06



17713.01



17715.02



17719.03



17404.03



17712.04



1 AIR CLEANER ASSEMBLIES

DESCRIPTION	PART #
1941-45 MB L-HEAD	17737.09
1941-45 MB L-HEAD, INCLUDES BRACKETS	17737.13
1945-49 CJ2A L-HEAD, INCLUDES BRACKETS	17737.13
1945-49 CJ2A L-HEAD	17737.09
1948-53 CJ3A L-HEAD	17737.09
1948-53 CJ3A L-HEAD, INCLUDES BRACKETS	17737.13

2 AIR CLEANER BRACKETS

DESCRIPTION	PART #
1941-45 MB, AIR CLEANER TO FIREWALL, LH	17737.12
1941-45 MB, AIR CLEANER TO FIREWALL, RH	17737.11
1945-49 CJ2A, AIR CLEANER TO FIREWALL, LH	17737.12
1945-49 CJ2A, AIR CLEANER TO FIREWALL, RH	17737.11
1948-53 CJ3A, AIR CLEANER TO FIREWALL, LH	17737.12
1948-53 CJ3A, AIR CLEANER TO FIREWALL, RH	17737.11

3 AIR CLEANER HOSES & TUBES

DESCRIPTION	PART #
1941-68 134 L-HEAD, RUBBER TUBE (air cleaner to air horn)	17737.01
1941-68 134 L-HEAD, RUBBER TUBE (air horn to carb)	17737.02
1941-45 MB 4-134 L-HEAD, AIR CLEANER LONG TUBE	12021.59
1946-49 CJ2A 4-134 L-HEAD, AIR CLEANER TUBE	12025.30
1948-53 CJ3A 4-134 L-HEAD, AIR CLEANER TUBE	12025.30
1953-65 CJ3B 4-134 F-HEAD, AIR CLEANER TUBE	12025.30
1955-68 CJ5 4-134 F-HEAD, AIR CLEANER TUBE	12025.30
1953-65 CJ3B 134 F-HEAD ENGINES, AIR CLEANER HOSE	17737.06
1955-71 CJ5 134 F-HEAD ENGINES, AIR CLEANER HOSE	17737.06
1955-71 CJ6 134 F-HEAD ENGINES, AIR CLEANER HOSE	17737.06

4 AIR CLEANER HORNS

DESCRIPTION	PART #
1941-45 MB, L-HEAD	12021.58
1945-49 CJ2A, L-HEAD	12021.58
1948-53 CJ3A, L-HEAD	12021.58
1955-65 CJ3B, F-HEAD	12025.29
1955-71 CJ5, F-HEAD	12025.29
1955-71 CJ6, F-HEAD	12025.29

5 AIR CLEANER WING NUTS

DESCRIPTION	PART #
1941-45 MB	17737.10
1941-49 CJ2A	17737.10
1948-53 CJ3A	17737.10

6 EGR VALVES

DESCRIPTION	PART #
1981-86 6 CYLINDER 4.2L CJ	17712.01
1981-86 6 CYLINDER 4.2L SJ	17712.01
1988-90 WRANGLER (2.5L, 4.0L, 4.2L)	17712.02
1988-90 CHEROKEE (2.5L, 4.0L)	17712.02
1993-98 GRAND CHEROKEE (NEW)	17712.03
2005-06 V8 4.7L GRAND CHEROKEE (NEW)	17712.04
2005-06 V8 GRAND CHEROKEE 5.7L	17712.05

7 AIR FILTERS

DESCRIPTION	PART #
1981-86 4 CYLINDER CJ, WITH CARB	17719.01
1974-86 6 CYLINDER CJ	17719.01
1974-83 V8 CJ	17719.03
1987-95 4 CYL WRANGLER, WITH FUEL INJECTION	17719.02
1991-96 6 CYLINDER WRANGLER	17719.02
1997-02 4 CYLINDER 2.5L WRANGLER	17719.04
1997-06 6 CYLINDER 4.0L WRANGLER	17719.04
2003-06 2.4L WRANGLER, GENUINE FRAM BRAND	17719.08
1987-01 CHEROKEE WITH FUEL INJECTION	17719.05
1993-98 GRAND CHEROKEE	17719.06
1999-04 GRAND CHEROKEE	17719.06
2005-06 GRAND CHEROKEE 4.7L & 5.7L, FRAM BRAND	17719.07
2007 GRAND CHEROKEE 3.7L, FRAM BRAND	17719.07
2006 COMMANDER, GENUINE FRAM BRAND	17719.07
2005-06 2.8L LIBERTY DIESEL, GENUINE FRAM	17719.07
2002-06 2.4L LIBERTY, GENUINE FRAM BRAND	17719.08
2002-07 3.7L LIBERTY, GENUINE FRAM BRAND	17719.07

8 PCV VALVES

DESCRIPTION	PART #
1971-83 V8 CJ	17404.03
1966-71 V6 225 (NEW)	17404.06
1980-89 4 CYLINDER	17404.01
1983-86 6 CYLINDER CJ	17404.02
1993 V8 GRAND CHEROKEE	17404.04
1994-98 V8 GRAND CHEROKEE	17404.05
2002-05 V6 3.7L LIBERTY (NEW)	17404.07
2002-05 V8 4.7L GRAND CHEROKEE (NEW)	17404.07
2005-06 V6 3.7L GRAND CHEROKEE (NEW)	17404.07
1999-01 V8 4.7L GRAND CHEROKEE (NEW)	17404.08
2002-03 4 CYLINDER 2.4L LIBERTY (NEW)	17404.09
2005-06 V8 GRAND CHEROKEE (NEW)	17404.12

9 IDLE AIR CONTROL MOTORS

DESCRIPTION	PART #
1991-97 4 CYLINDER 2.5L WRANGLER	17715.01
1998-99 4 CYLINDER 2.5L WRANGLER	17715.02
2005 4 CYLINDER 2.4L WRANGLER	17715.07
2000-02 4 CYLINDER 2.5L WRANGLER	17715.05
1991-97 6 CYLINDER 4.0L WRANGLER	17715.03
1998-99 6 CYLINDER 4.0L WRANGLER	17715.02
2000-04 6 CYLINDER 4.0L WRANGLER	17715.05
1986-90 6 CYLINDER 4.0L CHEROKEE	17715.06
1991-97 4 CYLINDER 2.5L CHEROKEE	17715.01
1998-99 4 CYLINDER 2.5L CHEROKEE	17715.02
1991-97 6 CYLINDER 4.0L CHEROKEE	17715.03
1998-99 6 CYLINDER 4.0L CHEROKEE	17715.02
2000-01 CHEROKEE	17715.05
1991-97 6 CYLINDER 4.0L GRAND CHEROKEE	17715.03
1998-99 6 CYLINDER 4.0L GRAND CHEROKEE	17715.02
1999-04 6 CYLINDER 4.0L GRAND CHEROKEE	17715.05
1993-98 V8 5.2L GRAND CHEROKEE	17715.04
1998 V8 5.9L GRAND CHEROKEE	17715.04
2004-05 4 CYLINDER 2.4L LIBERTY	17715.07

10 BREATHER

DESCRIPTION	PART #
1993-98 V8 GRAND CHEROKEE	17713.01



1 FUEL PUMPS

DESCRIPTION	PART #
1941-45 4 CYL 134 MB & GPW (w/o vacuum wipers) GLASS BOWL	17709.01
1946-49 4 CYL 134 CJ2A (w/o vacuum wipers) GLASS BOWL	17709.01
1948-53 4 CYL 134 CJ3A (w/o vacuum wipers) GLASS BOWL	17709.01
1953-65 4 CYL 134 CJ3B (w/o vacuum wipers) GLASS BOWL	17709.01
1955-71 4 CYL 134 CJ5 (w/o vacuum wipers) GLASS BOWL	17709.01
1955-71 4 CYL 134 CJ6 (w/o vacuum wipers) GLASS BOWL	17709.01
1941-45 4 CYL 134 MB & GPW (w/o vacuum wipers) METAL CAP	17709.02
1946-49 4 CYL 134 CJ2A (w/o vacuum wipers) METAL CAP	17709.02
1948-53 4 CYL 134 CJ3A (w/o vacuum wipers) METAL CAP	17709.02
1953-65 4 CYL 134 CJ3B (w/o vacuum wipers) METAL CAP	17709.02
1955-71 4 CYL 134 CJ5 (w/o vacuum wipers) METAL CAP	17709.02
1955-71 4 CYL 134 CJ6 (w/o vacuum wipers) METAL CAP	17709.02
1941-45 4 CYL 134 MB & GPW (with vacuum wipers)	17709.03
1946-49 4 CYL 134 CJ2A (with vacuum wipers)	17709.03
1948-53 4 CYL 134 CJ3A (with vacuum wipers)	17709.03
1953-65 4 CYL 134 CJ3B (with vacuum wipers)	17709.03
1955-71 4 CYL 134 CJ5 (with vacuum wipers)	17709.03
1955-71 4 CYL 134 CJ6 (with vacuum wipers)	17709.03
1980-83 4 CYLINDER CJ (GM 151)	17709.05
1983-86 4 CYLINDER CJ (AMC 150)	17709.06
1972-73 6 CYLINDER CJ	17709.12
1974-86 6 CYLINDER CJ	17709.06
1965-66 V6 225 CJ	17709.16
1967-71 V6 225 CJ	17709.17
1972-75 V8 CJ	17709.14
1976-83 V8 CJ	17709.15
1946-63 4 CYL 134 STATION WAGON (w/ vacuum wipers)	17709.04
1948-63 6 226 ENGINE	17709.10
1964-66 6 230 TORNADO ENGINE	17709.11
1987-90 4 CYLINDER WRANGLER (carbureted)	17709.07
1987-90 4 CYL WRANGLER, W/ FUEL INJ., ELEC.	17709.08
1991-93 6 CYL WRANGLER, W/ FUEL INJ., ELEC.	17709.09
1987-90 6 CYLINDER WRANGLER (rear inlet fitting)	17709.06
1987-90 6 CYLINDER WRANGLER (front inlet fitting)	17709.13
1986-90 4 CYL CHEROKEE, 2.5L, W/ FUEL INJ., ELEC.	17709.08
1987-93 6 CYL CHEROKEE 4.0L, W/ FUEL INJ., ELEC.	17709.09

2 FUEL MODULES (pump & sending unit assembly)

DESCRIPTION	PART #
1991-95 WRANGLER W/ FACTORY 20 GAL TANK	17724.16
2003-06 WRANGLER 2.4L & 4.0L W/ FACTORY 19 GALLON TANK	17709.26
1996 GRAND CHEROKEE	17709.20
1995 GRAND CHEROKEE	17709.21
1993-94 GRAND CHEROKEE	17709.22
1999-00 GRAND CHEROKEE (both 4.0L & 4.7L)	17709.24
2003-04 GRAND CHEROKEE (both 4.0L & 4.7L)	17709.23
2005-06 GRAND CHEROKEE 3.7L, 4.7L, 5.7L	17709.25

3 FUEL PUMP & FILTER ASSEMBLIES

DESCRIPTION	PART #
1994-96 2.5L & 4.0L WRANGLER	17709.18
1997-02 WRANGLER	17709.19
1994-96 2.5L & 4.0L CHEROKEE	17709.18
1997-00 CHEROKEE	17709.19
1997-98 GRAND CHEROKEE	17709.19

4 FUEL PRESSURE REGULATORS

DESCRIPTION	PART #
1991-98 4 CYLINDER 2.5L WRANGLER	17711.01
1991-98 6 CYLINDER 4.0L WRANGLER	17711.01
1991-96 4 CYLINDER 2.5L CHEROKEE	17711.01
1987-90 6 CYLINDER 4.0L CHEROKEE	17711.02
1991-96 6 CYLINDER 4.0L CHEROKEE	17711.01
1993-96 V8 5.2L GRAND CHEROKEE	17711.01

5 FUEL INJECTORS

DESCRIPTION	PART #
1991-95 4 CYLINDER 2.5L WRANGLER	17714.01
1996-02 4 CYLINDER 2.5L WRANGLER	17714.02
2003-04 2.4L WRANGLER	17714.11
1991-93 6 CYLINDER 4.0L WRANGLER	17714.04
1996-98 6 CYLINDER 4.0L WRANGLER	17714.02
1991-95 4 CYLINDER 2.5L CHEROKEE	17714.01
1996-02 4 CYLINDER 2.5L CHEROKEE	17714.02
1987-90 6 CYLINDER 4.0L CHEROKEE	17714.03
1991-93 6 CYLINDER 4.0L CHEROKEE	17714.04
1996-98 6 CYLINDER 4.0L CHEROKEE	17714.02
1999-01 4.0L CHEROKEE	17714.07
1996-98 6 CYLINDER 4.0L GRAND CHEROKEE	17714.02
1999-2004 4.0L GRAND CHEROKEE	17714.07
1993-95 V8 5.2L GRAND CHEROKEE	17714.06
1996-98 V8 5.2L GRAND CHEROKEE	17714.02
1999-00 4.7L GRAND CHEROKEE	17714.08
2001-04 4.7L GRAND CHEROKEE	17714.09
2002-04 2.4L LIBERTY	17714.11
2002-03 3.7L LIBERTY	17714.10

6 UNIVERSAL STEEL FUEL LINE

DESCRIPTION	PART #
13/16" X .028" COIL WITH 16 FITTINGS, 25'	16737.80
1/4" X .028" COIL WITH 14 FITTINGS, 25'	16737.81
5/16" X .028" COIL WITH 10 FITTINGS, 25'	16737.82
3/8" X .028" COIL WITH 6 FITTINGS, 25'	16737.83

7 FUEL LINE SETS

DESCRIPTION	PART #
1941-44 MB & GPW	17732.01
1945 MB & GPW	17732.02
1950-52 M38	17732.03
1951-68 M38A1	17732.04
1953-66 4-CYLINDER CJ5	17732.05
CJ2A, (all metal lines except for the hose)	17732.06

8 FUEL LINES

DESCRIPTION	PART #
1976-83 CJ5 6 CYLINDER, PUMP TO CARB	17732.22
1976-83 CJ5, RETURN LINE	17732.14
1976-83 CJ5 V8, TANK TO PUMP	17732.12
1976-83 CJ5, VAPOR LINE	17732.17
1976-81 CJ7 6 CYLINDER, RETURN LINE	17732.13
1976-81 CJ7 6 CYLINDER, RETURN LINE	17732.13
1976-81 CJ7 6 CYLINDER, VAPOR LINE	17732.19
1976-81 CJ7 V8, PUMP TO CARBURETOR	17732.26
1976-83 CJ7 6 CYLINDER, TANK TO PUMP	17732.08
1976-83 CJ7 V8, PUMP TO CARBURETOR	17732.07
1976-83 CJ7 V8, TANK TO PUMP	17732.11
1976-83 CJ7 V8, VAPOR LINE	17732.16
1982-86 CJ7 6 CYLINDER, RETURN LINE	17732.23
1982-86 CJ7 6 CYLINDER, TANK TO PUMP	17732.10
1982-86 CJ7 6 CYLINDER, VAPOR LINE	17732.18

9 JERRY CAN CARRIER BRACKET

DESCRIPTION	PART #
1941-68 MB, M38, M38A1, C.J.'S JERRY CAN CARRIER BRACKET (w/o jerry can)	12021.62

10 FUEL GAUGES

DESCRIPTION	PART #
1946-56 CJ (6V)	17210.06
1946-56 CJ (12V)	17210.07
1980-86 CJ, NEW BI-TORQUE DESIGN (paired w/ temp gauge) PAIR MUST BE USED TOGETHER	17209.02

GAS TANKS

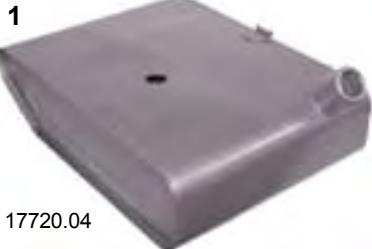

17720.04



17722.01



17721.02



17739.03

! WARNING
Restoration or replacement fuel tanks are direct replacements of original components and are not designed or warranted as meeting current safety standards (including FMVSS).



17724.09



17725.01

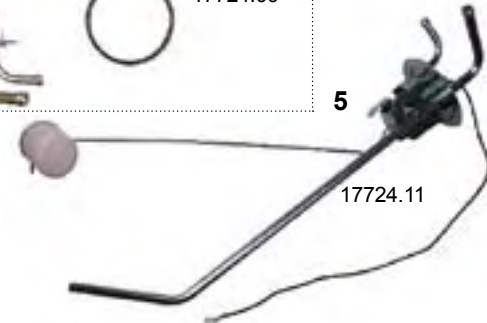

17724.11

1 STEEL GAS TANKS

DESCRIPTION	PART #
1941-42 EARLY MB, SMALL SPOUT, UNDER SEAT	17720.01
1942-45 LATE MB, LARGE SPOUT, UNDER SEAT	17720.02
1950-51 M38, UNDER SEAT	17720.03
1951-68 M38A1, UNDER SEAT	17720.07
1946-49 CJ2A	17720.04
1948-53 CJ3A	17720.04
1953 EARLY CJ3B	17720.04
1956-64 LATE CJ3B	17720.05
1955-67 CJ5, UNDER DRIVER SEAT	17720.06
1955-67 CJ6, UNDER DRIVER SEAT	17720.06
1970-75 CJ, 2.25" INLET DIAMETER, 6.5" FILLER NECK LENGTH	17720.08
1976-77 CJ, 2.25" INLET DIAMETER, 1.25" FILLER NECK LENGTH	17720.09
1978-86 CJ, 1" INLET DIAMETER	17720.10
1987-90 WRANGLER, 4 CYLINDER 2.5L ENGINE	17720.12
1987-90 WRANGLER, 6 CYLINDER 4.2L ENGINE	17720.13
1984-93 CHEROKEE, WITH CARB OR DIESEL, 20 GAL	17720.14
1986-96 CHEROKEE, WITH FUEL INJECTION	17720.15

2 STEEL GAS TANK SKID PLATES

DESCRIPTION	PART #
1976-86 CJ, SKID PLATE FOR 15 GAL TANKS	17721.01
1987-90 WRANGLER, SKID PLATE FOR 15 GAL TANKS	17721.01
1987-95 WRANGLER SKID PLATE FOR FACTORY 20 GAL FUEL TANK	17721.02

3 PLASTIC GAS TANKS

DESCRIPTION	PART #
1945-49 CJ2A, UNDER SEAT	17722.01
1945-49 CJ2A, UNDER PASS. SEAT	17722.02
1948-53 CJ3A, UNDER SEAT	17722.01
1948-53 CJ3A, UNDER PASS. SEAT	17722.02
1953 EARLY CJ3B, UNDER SEAT	17722.01
1953 EARLY CJ3B, UNDER PASS. SEAT	17722.02
1953-63 LATE CJ3B UNDER SEAT	17722.03
1963-63 LATE CJ3B UNDER PASSENGER SEAT	17722.04
1955-69 CJ5 UNDER SEAT	17722.05
1967-71 V6 CJ5 UNDER SEAT	17722.07
1967-71 V6 CJ5 UNDER PASSENGER SEAT	17722.08
1955-69 CJ6 UNDER SEAT	17722.05
1955-69 CJ5 UNDER PASSENGER SEAT	17722.06
1955-69 CJ6 UNDER PASSENGER SEAT	17722.06
1967-71 V6 CJ6 UNDER SEAT	17722.07
1967-71 V6 CJ6 UNDER PASSENGER SEAT	17722.08
1970-76 CJ 15 GALLON REAR MOUNTED	17722.09
1970-76 CJ 21 GALLON X-LARGE REAR MOUNT (replaces 15 gal stock)	17722.10
1978-86 CJ 15 GALLON	17722.11
1978-86 CJ5 & CJ7 20 GAL X-LARGE (replaces 15 gal stock)	17722.12
1978-86 CJ5 & CJ7 20 GAL X-LARGE (replaces 15 gal stock, includes mounting kit)	17722.22
1987-90 WRANGLER 15 GALLON	17722.13
1987-95 WRANGLER 20 GALLON (NEW)	17722.23
1947-63 WILLYS® PICK-UP (includes mounting kit)	17722.14
1962-77 JEEP® TRUCK J10 / J20 (needs 17723.01)	17722.15
1978-79 JEEP® TRUCK J10 / J20 MODELS W/ SIDE FILLER PIPE (needs 17723.01)	17722.16
1978-79 JEEP® TRUCK J10 / J20 MODELS W/ FRONT FILLER PIPE (needs 17723.01)	17722.20
1970-77 WAGONEER & CHEROKEE (includes mounting kit)	17722.18
1978-79 WAGONEER & CHEROKEE (includes mounting kit)	17722.19
1946-62 WAGON, (includes strap kit)	17722.21
STRAP KIT (needed when using 17722.15, .16 or .20)	17723.01

4 GAS TANK STRAPS

DESCRIPTION	PART #
1946-71 CJ, KIT, CENTER	12025.24
1976-86 CJ, CENTER	17739.01
1976-86 CJ (20 gal aftermarket plastic tank), CENTER	17739.03
1976-86 CJ, DRIVER SIDE	17739.04
1976-86 CJ, PASSENGER SIDE	17739.05
1987-90 WRANGLER, CENTER	17739.02
1997-05 WRANGLER, CENTER	17739.06
1987-90 WRANGLER, DRIVER SIDE	17739.04
1987-90 WRANGLER, PASSENGER SIDE	17739.05

5 FUEL TANK SENDING UNITS

DESCRIPTION	PART #
1946-49 CJ2A	17724.01
1946-49 CJ2A GASKET	17725.01
1948-53 CJ3A	17724.01
1948-53 CJ3A GASKET	17725.01
1953-58 EARLY CJ3B	17724.01
1953-58 EARLY CJ3B, GASKET	17725.01
1955-65 4 CYLINDER CJ3B	17724.02
1955-66 4 CYLINDER CJ5	17724.02
1967-71 4 CYLINDER CJ	17724.03
1967-71 V6 CJ	17724.04
1946-63 226 WAGON	17724.05
1946-63 226 TRUCK	17724.06
1970-86 CJ WITH 15 GAL TANK	17724.07
1970-86 CJ USING 17722.12 OR 17722.10 GAS TANKS	17724.11
1982-86 CJ WITH FACTORY 20 GAL TANK	17724.12
1982-86 CJ WITH FACTORY 20 GAL PLASTIC TANK KIT	17724.13
1982-86 CJ WITH FACTORY 20 GAL TANK, STEWART WARNER BRAND	17724.14
1991-96 WRANGLER, 20 GAL TANK	17724.16
POSTAL DJ'S	17724.17
1970-79 SJ WAGONEER	17724.18
1981-86 SJ WAGONEER	17724.20
1970-79 SJ TRUCK	17724.21

6 FUEL TANK SENDING UNIT KITS

DESCRIPTION	PART #
1970-86 CJ (sending unit, filter, O-ring & lock-ring)	17724.09
1982-86 CJ, STEWART WARNER SENDING UNIT KIT FOR FACTORY 20 GAL TANK	17724.15

7 FUEL TANK SENDING UNIT GASKET

DESCRIPTION	PART #
1946-49 CJ2A	17725.01
1948-53 CJ3A	17725.01
1953-58 EARLY CJ3B	17725.01
1955-66 4 CYLINDER (between tank & sending unit)	17725.02
1970-86 CJ (both 15 gal & factory 20 gal tanks)	17730.01
1987-93 WRANGLER	17730.02

8 MISC. FUEL TANK COMPONENTS

DESCRIPTION	PART #
1970-79 SJ WAGONEER FUEL PICK UP	17724.22
1970-86 CJ LOCK RING, 15 GAL FUEL TANK	17727.01
1982-86 CJ WITH FACTORY 20 GAL TANK LOCK NUT	17727.02
1987-90 WRANGLER LOCK RING	17727.03
PLASTIC FLOAT (will fit all our CJ sending units)	17729.01
MB, GPW, CJ2A, CJ3A, CJ3B, M38, CJ5 41-69 GAS TANK FELT KIT (NEW)	12021.87



1 FUEL FILLER HOSES

DESCRIPTION	PART #
1970-75 CJ	17740.01
1976 CJ	17740.02
1978-86 CJ5, CJ7 (factory 15 gal tank)	17740.03
1982-86 CJ5 W/ FACTORY 20 GAL, 1-1/4" DIAMETER	17740.04
1982-86 CJ7 W/ FACTORY 20 GAL, 1-1/4" DIAMETER	17740.04
1982-86 CJ8 W/ FACTORY 15 GAL, 1" DIAMETER	17740.05
1987-90 WRANGLER, 1" DIAMETER	17740.06
1991-95 WRANGLER WITH 20 GAL TANK	17740.07
1997-02 WRANGLER	17740.08

2 FUEL TANK VENT HOSES

DESCRIPTION	PART #
1978-86 CJ5 (factory 15 gallon tank)	17741.01
1982-86 CJ5 WITH FACTORY 20 GAL TANK, 1" DIA	17741.02
1978-86 CJ7 (factory 15 gal tank)	17741.01
1982-86 CJ7 WITH FACTORY 20 GAL TANK, 1" DIA.	17741.02
1982-86 CJ8 WITH FACTORY 15 GAL	17741.03
1987-90 WRANGLER, 11/16" DIAMETER	17741.04
1991-95 WRANGLER WITH 20 GALLON TANK	17741.05
1997-02 WRANGLER	17741.06

3 FUEL FILLER NECKS

DESCRIPTION	PART #
1977-86 CJ5	17743.01
1977-86 CJ7	17743.01
1981 CJ8	17743.01
1991-95 WRANGLER, FITS 15 & 20 GALLON MODELS	17743.03
1997-02 WRANGLER (PLASTIC)	17742.02

4 FUEL TANK FILLER NECK GROMMETS

DESCRIPTION	PART #
1945-71 CJ	12025.23
1953-71 M38 & M38A1	12023.11

5 FUEL TANK FILLER NECK PROTECTORS

DESCRIPTION	PART #
1946-71 CJ	12025.25
1977-86 CJ, PLASTIC	17742.01
1977-86 CJ, STAINLESS STEEL	11135.01
1987-95 WRANGLER, PLASTIC	17742.01
1987-95 WRANGLER, STAINLESS STEEL	11135.01
1997-06 WRANGLER, STAINLESS STEEL	11135.02

6 HOSE CLAMPS

DESCRIPTION	PART #
HOSE CLAMP 1-1/4", TO FIT MANY FUEL HOSES	17744.01
HOSE CLAMP 1-1/2", TO FIT MANY FUEL HOSES	17744.02
HOSE CLAMP 3", TO FIT MANY FUEL HOSES	17744.03

7 IN-LINE FUEL FILTER KITS

DESCRIPTION	PART #
CJ KIT W/ HOSES & CLAMPS, SINGLE OUTLET	17718.01
CJ KIT W/ HOSES & CLAMPS, DUAL OUTLET	17718.02
1987-95 4 CYLINDER 2.5L WRANGLER	17718.03
1987-90 6 CYLINDER WRANGLER 4.2L, KIT WITH HOSES & CLAMPS, DUAL OUTLET	17718.02
1997-04 WRANGLER	17718.05
1984-95 4 OR 6 CYLINDER CHEROKEE	17718.03
1997-01 CHEROKEE	17718.05
1993-96 6 OR 8 CYLINDER GRAND CHEROKEE	17718.04
1997-98 GRAND CHEROKEE	17718.05
1999-04 GRAND CHEROKEE (pressure regulator mounted)	17718.06

8 IN-TANK FUEL FILTERS

DESCRIPTION	PART #
1970-86 CJ WITH FACTORY 15 GALLON TANK	17728.01
1982-86 CJ WITH FACTORY 20 GALLON TANK	17728.02

9 GAS CAPS

DESCRIPTION	PART #
MB & CJ :	
1942-44 LATE MB, GPW, NON-LOCKING	17726.01
1946-71 CJ WITHOUT LOCK (shiny), NON-LOCKING	17726.02
1946-71 CJ WITH CHECK VALVE, OE STYLE, BLACK, NON-LOCKING	17726.03
1971-76 CJ, NON-LOCKING	17726.04
1971-76 CJ LOCKING	17726.05
1977-86 CJ, LOCKING	17726.06
1977-90 CJ, NON-LOCKING, NON-VENTED	17726.07
WRANGLER :	
1987-90 WRANGLER, LOCKING	17726.06
1987-90 WRANGLER, NON-LOCKING, NON-VENTED	17726.07
1991-95 WRANGLER, LOCKING	17726.08
1997-00 WRANGLER, LOCKING	17726.08
1991-95 WRANGLER, NON-LOCKING, NON-VENTED	17726.09
1997-00 WRANGLER, NON-LOCKING, NON-VENTED	17726.09
2001 4 CYLINDER WRANGLER, LOCKING	17726.08
2001 4 CYL WRANGLER, NON-LOCKING, NON-VENTED	17726.09
2001 6 CYLINDER WRANGLER, LOCKING	17726.10
2002 WRANGLER, LOCKING	17726.10
2002-04 WRANGLER, NON-LOCKING	17726.12
CHEROKEE :	
1984-99 CHEROKEE LOCKING	17726.08
1984-99 CHEROKEE, NON-LOCKING, NON-VENTED	17726.09
2000-01 CHEROKEE, LOCKING	17726.10
GRAND CHEROKEE & LIBERTY :	
1993-98 GRAND CHEROKEE LOCKING	17726.08
1999-00 GRAND CHEROKEE, LOCKING	17726.08
1993-98 GRAND CHEROKEE, NON-LOCKING, NON-VENTED	17726.09
1999-00 GRAND CHEROKEE, NON-LOCKING, NON-VENTED	17726.09
2002 GRAND CHEROKEE, LOCKING	17726.10
2001 6 CYLINDER GRAND CHEROKEE, LOCKING	17726.10
2001-02 GRAND CHEROKEE, NON-LOCKING	17726.12
LIBERTY & SJ :	
2002 LIBERTY, LOCKING	17726.10
1947-63 WAGON & TRUCK, NON LOCKING	17726.11
1963-71 SJ, NON-LOCKING, NON-VENTED	17726.13



1 HEATER CORES

DESCRIPTION	PART #
1972-77 CJ WITH 2 SPEED HEATER MOTOR	17901.01
1978-86 CJ WITH 3 SPEED HEATER MOTOR	17901.02
1987-95 4 OR 6 CYLINDER WRANGLER	17901.03
1997-01 WRANGLER	17901.04
2002-06 WRANGLER (will not fit 1997-01 WRANGLER)	17901.05
1997-01 CHEROKEE	17901.04
1984-96 CHEROKEE	17901.08
1993-98 GRAND CHEROKEE	17901.09
1999-03 4.0L GRAND CHEROKEE (NEW)	17901.10
1999-03 4.7L GRAND CHEROKEE (NEW)	17901.10
2002-07 LIBERTY (NEW)	17901.11
1972-77 SJ	17901.06
1978-83 SJ	17901.07

2 BLOWER MOTORS

DESCRIPTION	PART #
1972-77 CJ	17904.01
1978-86 CJ (hole in firewall may need to be enlarged)	17904.02
1987-90 WRANGLER (hole in firewall may need to be enlarged)	17904.02
WRANGLER	17904.03
1988-93 CHEROKEE	17904.04
1993-98 GRAND CHEROKEE	17904.05

3 FRESH AIRBOX SYSTEM

DESCRIPTION	PART #
1972-77 CJ5, WITH BRACKETS	17906.01
1966-73 COMMANDO, W/ BRACKETS	17906.01

4 HEATER SWITCHES

DESCRIPTION	PART #
1976-77 CJ 2 SPEED	17903.01
1997-02 WRANGLER (NEW)	17903.04
1978-86 CJ 3 SPEED	17903.02
1991-93 CHEROKEE WITHOUT A/C (NEW)	17903.03
1994-96 CHEROKEE (NEW)	17903.03
1993 GRAND CHEROKEE WITHOUT A/C (NEW)	17903.03

5 HEATER CABLES (will not fit 1976-77 CJ)

DESCRIPTION	PART #
1978-86 CJ, HEATER DEFROST CABLE 21"	17905.01
1978-86 CJ, HEATER TEMP CABLE 21.5"	17905.02
1978-86 CJ, HEATER AIR CABLE 28"	17905.03
1978-86 CJ, VENT CABLE KIT, 3 PIECES	17905.04

6 HVAC DOOR LEVERS

DESCRIPTION	PART #
1997-01 WRANGLER, FOR LOWER AC PANEL DOOR	17910.01
1997-01 WRANGLER, FOR UPPER DEFROSTER DOOR	17910.02

7 DEFROST DUCTS

DESCRIPTION	PART #
1955-77 CJ, DEFROST DUCT (plastic)	17907.01
1978-86 CJ, DEFROST DUCT HOSE, OVAL SHAPE	17907.02
1978-86 CJ, DEFROST DUCT, OVAL SHAPE (plastic)	17907.03
1976-86 CJ, DEFROSTER DEFLECTOR (pair)	17907.04
1978-86 CJ, FLOOR HEATER DUCT CONVERSION (WRANGLER version)	17907.05
1987-95 WRANGLER FLOOR HEATER DUCT	17907.05

8 HEATER TUBE, MOTOR SEALS & MISC. ITEMS

DESCRIPTION	PART #
1978-86 CJ, HEATER CORE TUBE SEAL	17908.01
1978-86 CJ, FIREWALL HEATER MOTOR SEAL	17908.02
1968-86 CJ HEATER SWITCH KNOB	13318.05
1999-06 WRANGLER CLIMATE CONTROL KNOB (NEW)	17903.20
1987-95 WRANGLER, HEATER CORE TUBE SEAL	17908.01
1987-90 WRANGLER, FIREWALL HEATER MOTOR SEAL	17908.02
1991-95 WRANGLER, FIREWALL HEATER MOTOR SEAL	17908.03

9 HEATER BLOWER MOTOR RESISTORS

DESCRIPTION	PART #
1997-04 WRANGLER	17909.03
1991-96 CHEROKEE	17909.01
1997-99 CHEROKEE WITH A/C	17909.03
1993-94 GRAND CHEROKEE WITH A/C	17909.03
1993-00 GRAND CHEROKEE WITHOUT A/C (NEW)	17909.02
1993-98 CHEROKEE WITHOUT A/C (NEW)	17909.02

10 A/C COMPRESSORS

DESCRIPTION	PART #
1984-90 4 CYLINDER CHEROKEE	17953.01
1984-86 2.8L V6 CHEROKEE	17953.01
1987-90 SJ 4.2L 6 CYLINDER	17953.01

11 A/C CONDENSERS

DESCRIPTION	PART #
1987-90 CHEROKEE, WITH FACTORY A/C, EXPANSION VALVE	17950.01
1987-95 4 or 6 CYLINDER WRANGLER	17950.02
1997-00 4 or 6 CYLINDER WRANGLER	17950.03
1987-97 4 CYLINDER CHEROKEE	17950.04
1984-86 2.8L V6 CHEROKEE	17950.04
1987-91 6 CYLINDER CHEROKEE	17950.05
1992-97 6 CYLINDER CHEROKEE W/ SERPENTINE	17950.06
1997-01 6 CYLINDER CHEROKEE W/ PARALLEL FLOW	17950.07
1993-98 6 OR 8 CYLINDER GRAND CHEROKEE	17950.08
1999-03 6 OR 8 CYLINDER GRAND CHEROKEE	17950.09

12 A/C DRIERS

DESCRIPTION	PART #
1984-86 2.5L, 2.8L V6, 2.1L DIESEL CHEROKEE	17951.01
1987-96 4 CYLINDER CHEROKEE	17951.02
1987-90 6 CYLINDER CHEROKEE	17951.03
1991-96 6 CYLINDER CHEROKEE W/ R12 SYSTEM	17951.04
1994-96 6 CYLINDER CHEROKEE W/ R134A SYSTEM	17951.05
1993-94 6 CYLINDER GRAND CHEROKEE	17951.06
1993-95 V8 GRAND CHEROKEE	17951.07

13 A/C EVAPORATORS

DESCRIPTION	PART #
1987-90 4 OR 6 CYLINDER CHEROKEE	17952.01
1991-93 4 OR 6 CYLINDER CHEROKEE	17952.02
1994-96 4 OR 6 CYLINDER CHEROKEE	17952.03
1993 6 OR 8 CYLINDER GRAND CHEROKEE	17952.04



18027.01



UPGRADE

18021.02



18003.02



18003.03

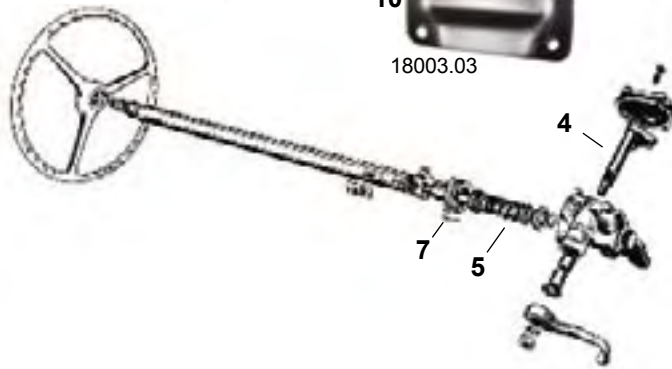

This overkill mount eliminates the two piece OE version that is prone to fatigue and cracking over time. With this mount, we have integrated a clamshell frame plate to eliminate any possible weak point in the steering box mounting system. Kit is complete with all hardware and instructions. This is the last steering box mount you'll ever need to buy.

UPGRADE

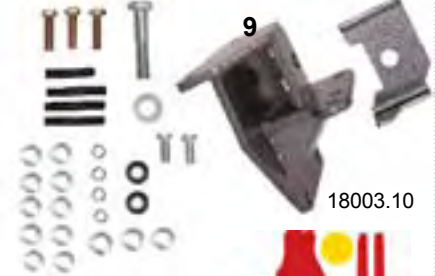

18003.10



18029.01

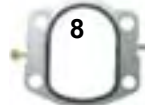

18005.03



18028.01

1 MANUAL STEERING GEAR BOX ASSEMBLIES

DESCRIPTION	PART #
1972-86 CJ GEAR BOX ASSEMBLY	18001.01
1972-86 RIGHT HAND DRIVE & POSTAL	18001.02
1987-99 WRANGLER	18001.03
1984-96 CHEROKEE	18001.03
1974-86 SJ GEAR BOX ASSEMBLY	18001.01

2 POWER STEERING GEAR BOX ASSEMBLIES

DESCRIPTION	PART #
1987-95 WRANGLER	18004.02
1984-90 CHEROKEE	18004.03
1991-96 CHEROKEE	18004.04
1997-01 CHEROKEE, LHD	18004.08
1993-95 V8 GRAND CHEROKEE WITH TRAILER TOW	18004.05
1993-98 V8 GRAND CHEROKEE W/O TRAILER TOW	18004.05
1999-04 6 or 8 CYL GRAND CHEROKEE, LHD	18004.06
1999-04 6 or 8 CYL, GRAND CHEROKEE, RHD	18004.09
2003-04 GRAND CHEROKEE, (export models only), LHD	18004.07

3 REBUILT POWER STEERING GEAR BOX ASSYM

DESCRIPTION	PART #
1972-79 CJ	18004.71
1980-86 CJ	18004.72
1987-95 WRANGLER	18004.73
1997-02 WRANGLER	18004.74

4 STEERING GEAR BOX SECTOR SHAFTS

DESCRIPTION	PART #
1941-45 MB, SECTOR SHAFT	18027.01
1945-71 4 CYLINDER CJ, SECTOR SHAFT	18027.01

5 STEERING GEAR BOX WORM SHAFTS

DESCRIPTION	PART #
1941-45 MB, WORM SHAFT, 40.5"	18028.01
1945-49 CJ2A, WORM SHAFT, 40.5"	18028.01
1949-71 4 CYLINDER CJ, WORM SHAFT, 41.5"	18028.02

6 STEERING GEAR BOX COMPONENTS

DESCRIPTION	PART #
1941-45 MB, OUTER SECTOR SHAFT BUSHING	18029.05
1941-45 MB, INNER SECTOR SHAFT BUSHING	18029.06
1941-71 MB & 4 CYL CJ, WORM SHAFT BEARING KIT	18029.01
1951-68 M38 & M38A1 SECTOR SHAFT BUSHING (long)	18029.07
1951-68 M38 & M38A1 SECTOR SHAFT BUSHING (short)	18029.08
1945-71 4 CYL CJ, OUTER SECTOR SHAFT BUSHING	18029.05
1945-71 CYL CJ, INNER SECTOR SHAFT BUSHING	18029.06
1972-86 CJ MAN, STEERING SECTOR SHAFT BUSHING	18002.02
1974-86 SJ MAN, STEERING SECTOR SHAFT BUSHING	18002.02

7 STEERING GEAR BOX SHIMS

DESCRIPTION	PART #
1941-71 4 CYLINDER (ALL), STEERING SHIM KIT	18029.02

8 STEERING GEAR BOX SEALS & REPAIR KITS

DESCRIPTION	Stock No.
1941-45 MB, OIL SEAL, STEERING BOX	18029.03
1950-71 M38, M38A1, V6 CJ SECTOR SHAFT OIL SEAL	18029.04
1945-71 4 CYL CJ, OIL SEAL, STEERING BOX	18029.03
1972-86 CJ MAN, STEERING SECTOR SHAFT OIL SEAL	18002.03
1972-86 CJ, WORM SHAFT OIL SEAL	18002.04
1974-86 SJ MAN, STEERING SECTOR SHAFT OIL SEAL	18002.03
1974-86 SJ, WORM SHAFT OIL SEAL	18002.04
1974-99 ALL MODELS, VALVE RING & SEAL REPAIR KIT	18005.01
1974-99 ALL MODELS, PITMAN ARM SEAL REPAIR KIT	18005.02
1997-02 ALL P/S BOXES, PITMAN ARM SEAL REPAIR KIT	18005.03

9 STEERING GEAR BOX BRACES/MOUNTS

DESCRIPTION	PART #
1972-75 CJ	18021.01
1976-86 CJ, HEAVY DUTY (UPGRADE)	18021.02
1976-86 CJ HEAVY DUTY STEERING BOX MOUNT (w/ p/s)	18003.10
1984-01 CHEROKEE (UPGRADE)	18021.05

10 STEERING GEAR BOX BRACKETS

DESCRIPTION	PART #
1976-86 CJ, STEERING BOX MOUNT TIE PLATE	18003.01
1976-86 CJ, STEERING BOX UPPER MOUNT BRKT.	18003.02
1976-86 CJ, STEERING BOX LOWER MOUNT BRKT.	18003.03

POWER STEERING & STEERING WHEELS

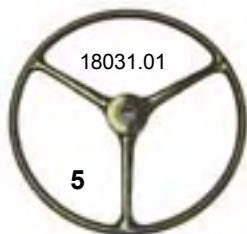
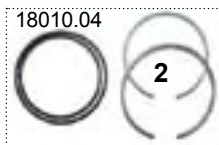

1 POWER STEERING PUMPS (pulley not included)

DESCRIPTION	PART #
1980-86 6 OR 8 CYL CJ, WITHOUT RESERVOIR (NEW)	18008.03
1991-95 WRANGLER	18008.04
1997-02 2.5L WRANGLER	18008.11
1997-05 4.0L WRANGLER	18008.17
2003-06 2.4L WRANGLER	18008.19
1987-90 4.0L CHEROKEE	18008.20
1990 4.0L CHEROKEE	18008.14
1991-96 2.5L CHEROKEE WITH GAS ENGINE	18008.16
1992-95 4 CYLINDER 2.5L CHEROKEE	18008.06
1993-95 V8 GRAND CHEROKEE	18008.10
1994-97 CHEROKEE EXPORT	18008.09
1996-98 6 CYLINDER 4.0L CHEROKEE	18008.08
1996-98 V8 GRAND CHEROKEE (without speed proportional steering)	18008.10
2001-04 4.0L GRAND CHEROKEE	18008.15
2001-04 4.7L GRAND CHEROKEE	18008.13
2002-04 3.7L LIBERTY	18008.12

2 POWER STEERING PUMP SEALS

DESCRIPTION	PART #
1987-95 WRANGLER, SEAL KIT, ADJUSTING PLUNGE	18010.02
1997-02 WRANGLER W/ P/S, PITMAN ARM SEAL KIT	18010.03
1987-95 WRANGLER, VALVE RING SEAL KIT	18010.04
1987-95 WRANGLER, POWER STEERING O-RING KIT	18010.05
1987-90 4.0L CHEROKEE, SAGINAW SEAL KIT	18010.01
1987-96 CHEROKEE, SEAL KIT, ADJUSTING PLUNGE	18010.02
1997-02 CHEROKEE W/ P/S, PITMAN ARM SEAL KIT	18010.03
1987-96 CHEROKEE, VALVE RING SEAL KIT	18010.04
1987-96 CHEROKEE, POWER STEERING O-RING KIT	18010.05
1987-96 GRAND CHEROKEE, SEAL KIT, ADJ. PLUNGE	18010.02
1993-96 GRAND CHEROKEE, VALVE RING SEAL KIT	18010.04
1993-96 GRAND CHEROKEE, P/S O-RING KIT	18010.05

3 POWER STEERING PRESSURE HOSES (pump to gear box)

DESCRIPTION	PART #
1976-79 6 OR 8 CYLINDER CJ	18012.01
1980-83 8 CYLINDER CJ	18012.03
1980-86 6 CYLINDER CJ	18012.02
1987-90 4 CYLINDER WRANGLER	18012.05
1987-90 6 CYLINDER WRANGLER	18012.04
1991-95 4 CYLINDER WRANGLER	18012.07
1991-95 6 CYLINDER WRANGLER	18012.06
1997-02 2.5L WRANGLER	18012.13
1999-02 4.0L WRANGLER	18012.17
1984-85 4 CYLINDER CHEROKEE	18012.08
1984-86 V6 (2.8L) CHEROKEE	18012.08
1986 4 CYLINDER CHEROKEE	18012.09
1987-90 6 CYLINDER CHEROKEE	18012.10
1991-96 6 CYLINDER CHEROKEE	18012.11
1997-01 4.0L CHEROKEE	18012.12
1993-96 6 CYLINDER GRAND CHEROKEE	18012.11
1993-98 GRAND CHEROKEE WITH PROPORTIONING STEERING	18012.15
1993-98 GRAND CHEROKEE WITHOUT PROPORTIONING STEERING, GATE	18012.14
1999-00 4.7L GRAND CHEROKEE	18012.16

4 POWER STEERING RETURN HOSES (gear box to pump)

DESCRIPTION	PART #
1976-79 6 OR 8 CYL CJ	18014.01
1980-83 8 CYLINDER CJ	18014.03
1980-86 6 CYLINDER CJ	18014.02
1983-86 2.5L AMC CJ	18014.13
1991-95 6 CYL WRANGLER (pump to reservoir connection)	18014.06
1991-96 4.0L WRANGLER	18014.11
1997-02 4.0L WRANGLER	18014.08
1987-90 6 CYLINDER CHEROKEE	18014.07
1992-01 4.0L CHEROKEE	18014.11
1998-00 2.5L CHEROKEE	18014.10
1993-98 GRAND CHEROKEE (Gate brand)	18014.09
1999-00 4.7L GRAND CHEROKEE (w/o p/s cooler tube)	18014.12

5 STEERING WHEELS

DESCRIPTION	PART #
1941-45 MB, ORIGINAL STYLE STEERING WHEEL, METAL SPOKES, GREEN	18031.03
1945-49 CJ2A, ORIGINAL STYLE STEERING WHEEL (horn button size 1.25"), BLACK	18031.01
1948-53 CJ3A, ORIGINAL STYLE STEERING WHEEL (horn button size 1.25"), BLACK	18031.01
1953-64 CJ3B, ORIGINAL STYLE STEERING WHEEL (horn button size 1.25"), BLACK	18031.01
1955-64 CJ5, ORIGINAL STYLE STEERING WHEEL (horn button size 1.25"), BLACK	18031.01
1955-64 CJ6, ORIGINAL STYLE STEERING WHEEL (horn button size 1.25"), BLACK	18031.01
1953-64 M38, ORIGINAL STYLE STEERING WHEEL (horn button size 1.25"), GREEN	18031.02
1953-64 M38A1, ORIGINAL STYLE STEERING WHEEL (horn button size 1.25"), GREEN	18031.02
1964-75 CJ5, ORIGINAL STYLE STEERING WHEEL (horn button size 2-3/8"), BLACK	18031.04
1964-75 CJ6, ORIGINAL STYLE STEERING WHEEL (horn button size 2-3/8"), BLACK	18031.04
1976-86 CJ, SPORT, METAL 3-SPOKE DESIGN, BLACK	18031.05
1976-86 CJ, SPORT, METAL 3-SPOKE DESIGN, BLACK	18031.06
1976-86 CJ, LEATHER TRIM STEERING WHEEL KIT	18031.08
1976-86 CJ, STEERING WHEEL KIT & HORN BUTTON CAP	18031.07
1987-95 WRANGLER, SPORT, METAL THREE SPOKE DESIGN, BLACK W/ LEATHER TRIM	18031.05
1987-95 WRANGLER, SPORT, METAL THREE SPOKE DESIGN, BLACK W/ LEATHER TRIM	18031.06
1987-95 WRANGLER, STEERING WHEEL KIT & HORN BUTTON CAP	18031.07
1987-95 WRANGLER, LEATHER TRIM STEERING WHEEL KIT	18031.08

6 HORN BUTTON

DESCRIPTION	PART #
1941-45 MB, HORN BUTTON KIT (with nut & wiring)	18032.01
1941-45 MB, HORN CONTACT BUSHING	18032.06
1945-49 CJ2A, HORN BUTTON KIT (with nut & wiring)	18032.01
1945-49 CJ2A, HORN CONTACT BUSHING	18032.06
1951-53 CJ3A, HORN BUTTON & NUT	18032.02
1951-53 CJ3A, HORN BUTTON (with nut & wiring)	18032.03
1953-64 CJ3B, HORN BUTTON & NUT	18032.02
1953-64 CJ3B, HORN BUTTON (with nut & wiring)	18032.03
1964-65 CJ3B, HORN BUTTON KIT (with nut & wiring)	18032.04
1964-65 CJ3B, HORN BUTTON ONLY, RUBBER	18032.05
1955-64 CJ5, HORN BUTTON & NUT	18032.02
1955-64 CJ5, HORN BUTTON (with nut & wiring)	18032.03
1964-75 CJ5, HORN BUTTON KIT (with nut & wiring)	18032.04
1964-75 CJ5, HORN BUTTON ONLY, RUBBER	18032.05
1964-75 CJ6, HORN BUTTON KIT (with nut & wiring)	18032.04
1964-75 CJ6, HORN BUTTON ONLY, RUBBER	18032.05
1976-86 CJ, HORN BUTTON CAP, BLACK	18033.01
1987-95 WRANGLER, HORN BUTTON CAP, BLACK	18033.01



1 STEERING COLUMN

DESCRIPTION	PART #
1941-45 4 CYL MB & GPW STEERING COLUMN BEARING	18030.02
1949 4 CYL CJ2A, STEERING COLUMN TUBE	18030.01
1945-49 4 CYL CJ2A STEERING COLUMN BEARING	18030.02
1948-53 4 CYL CJ3A, STEERING COLUMN TUBE	18030.01
1948-53 4 CYL CJ3A STEERING COLUMN BEARING	18030.02
1953-65 4 CYL CJ3B, STEERING COLUMN TUBE	18030.01
1953-65 4 CYL CJ3B STEERING COLUMN BEARING	18030.02
1955-71 4 CYL CJ5, STEERING COLUMN TUBE	18030.01
1955-71 4 CYL CJ5 STEERING COLUMN BEARING	18030.02
1955-71 4 CYL CJ6, STEERING COLUMN TUBE	18030.01
1955-71 4 CYL CJ6 STEERING COLUMN BEARING	18030.02

2 STEERING COLUMN SEALS

DESCRIPTION	PART #
1976-86 CJ, STEERING COLUMN TO FIREWALL SEAL	18020.01
1987-95 WRANGLER, STEERING COLUMN TO FIREWALL SEAL	18020.01

3 STEERING COLUMN COVERS

DESCRIPTION	PART #
1976-86 CJ, PLASTIC (black)	13318.08
1976-86 CJ, PLASTIC (chrome plated)	18090.01
1976-86 CJ, STAINLESS STEEL (flat style)	11128.01

4 STEERING COLUMN SECTOR KITS

DESCRIPTION	PART #
1984-86 CJ	18020.02
1987-94 WRANGLER	18020.02
1984-94 CHEROKEE	18020.02

5 LOWER STEERING SHAFT ASSEMBLIES

DESCRIPTION	PART #
1976-86 CJ WITH MANUAL STEERING	18016.01
1976-86 CJ WITH POWER STEERING	18016.02
1976-86 CJ WITH MANUAL STEERING, HEAVY DUTY (NEW)	18024.01
1976-86 CJ WITH POWER STEERING, HEAVY DUTY (NEW)	18024.02
1987-95 WRANGLER WITH POWER STEERING	18016.03

6 LOWER STEERING SHAFT COMPONENTS

DESCRIPTION	PART #
1976-86 CJ, LOWER SHAFT COLUMN BEARING	18019.01
1976-86 CJ, PLASTIC RETAINER, LOWER COLUMN	18019.02
1976-86 CJ, LOWER COLUMN RETAINER, BEARING & HARDWARE KIT	18019.03
1987-95 WRANGLER, LOWER SHAFT COLUMN BEARING	18019.01
1987-95 WRANGLER, LWR COLUMN PLASTIC RETAINER	18019.02
1987-95 WRANGLER, LOWER COLUMN RETAINER, BEARING & HARDWARE KIT	18019.03

7 LOWER STEERING SHAFT COUPLING

DESCRIPTION	PART #
1972-75 CJ, STEERING SHAFT YOKE ASSY. W/ U-JOINT	18017.01
1972-75 CJ, SPARE U-JOINT KIT FOR STEERING YOKE	18017.02
1976-86 CJ, SPARE BOOT FOR COUPLING	18018.01
1976-86 CJ, SPARE BOOT KIT W/ 2 NUT BEARINGS & SPRING	18018.02
1976-86 CJ, SPARE COUPLING, MANUAL STEERING	18018.03
1976-86 CJ, SPARE COUPLING KIT W/ HARDWARE, MANUAL STEERING	18018.04
1976-86 CJ, SPARE COUPLING, POWER STEERING	18018.05
1976-86 CJ, SPARE COUPLING KIT W/ H/W, P/S	18018.06
1976-86 CJ, STEERING COUPLING CLAMP	18018.07
1976-86 CJ, COUPLING NUT BEARING (need 2)	18018.08
1976-86 CJ, COUPLING NUT SPRING	18018.09

8 BALL JOINT KIT PAIRS (Kit = 1 upper, 1 lower & hardware)

DESCRIPTION	PART #
1972-86 CJ, LEFT OR RIGHT	18036.01
1987-04 WRANGLER, LEFT OR RIGHT	18036.02
1984-01 CHEROKEE, LEFT OR RIGHT	18036.02
1993-98 GRAND CHEROKEE, LEFT OR RIGHT	18036.02
SAME AS 18036.02 -SPICER BRAND	18036.03
1999-04 GRAND CHEROKEE	18036.04
1974-91 SJ, LEFT OR RIGHT	18036.01

9 UPPER BALL JOINT KITS (includes hardware)

DESCRIPTION	PART #
1972-86 CJ, LEFT OR RIGHT	18037.01
1987-06 WRANGLER, LEFT OR RIGHT	18037.02
1987-01 CHEROKEE, LEFT OR RIGHT	18037.02
1993-98 GRAND CHEROKEE, LEFT OR RIGHT	18037.02
1974-86 SJ, LEFT OR RIGHT	18037.01

10 LOWER BALL JOINT KITS (includes hardware)

DESCRIPTION	PART #
1972-86 CJ, LEFT OR RIGHT	18038.01
1987-06 WRANGLER, LEFT OR RIGHT	18038.02
1987-01 CHEROKEE, LEFT OR RIGHT	18038.02
1993-98 GRAND CHEROKEE, LEFT OR RIGHT	18038.02
2002-05 LIBERTY, LEFT OR RIGHT	18038.03
1974-86 SJ, LEFT OR RIGHT	18038.01

11 BALL JOINT SPANNER WRENCH

DESCRIPTION	PART #
1974-86 CJ & SJ, (for installing upper ball joint)	18039.01

12 STEERING KNUCKLE COMPONENTS

DESCRIPTION	PART #
1945-71 CJ STEERING KNUCKLE, LEFT	18026.01
1945-71 CJ STEERING KNUCKLE, RIGHT	18026.02
1945-71 ALL, STEERING KNUCKLE FELT & SEAL KIT, ONE SIDE	18026.03
1941-71 ALL, STEERING KNUCKLE KING PIN BEARING CAP (each)	18026.04
1941-71 ALL, STEERING KNUCKLE KING PIN BEARING (each)	18026.05
1941-71 ALL, STEERING KNUCKLE KING PIN CUP (each)	18026.06
1941-71 ALL, STEERING KNUCKLE KING PIN SHIM SET (each)	18026.07
1974-92 SJ, SPINDLE WASHER	16527.35
1974-92 SJ, SPINDLE INNER NUT	16527.36
1974-92 SJ, SPINDLE OUTER NUT	16527.37

13 PITMAN ARMS (for LHD only - will not fit RHD)

DESCRIPTION	PART #
1941-71 4 CYL MB & CJ (will not fit M38, M38A1, or 6 CYL CJ)	18006.30
1976-86 CJ WITH 4 INCH LIFT, POWER STEERING UPGRADE	18006.51
1976-86 CJ WITH MANUAL STEERING	18006.02
1976-86 CJ WITH POWER STEERING	18006.01
1987-06 WRANGLER WITH 4 INCH OR MORE LIFT, P/S UPGRADE	18006.50
1987-95 WRANGLER WITH MANUAL STEERING	18006.04
1987-95 WRANGLER WITH POWER STEERING	18006.03
1993-98 GRAND CHEROKEE	18006.09
1997-06 WRANGLER WITH POWER STEERING	18006.05
1997-06 WRANGLER WITH MANUAL STEERING	18006.06
1984-01 CHEROKEE, WITH POWER STEERING	18006.08
1999-04 GRAND CHEROKEE	18006.10

14 STEERING DAMPER, O.E. STYLE

DESCRIPTION	PART #
1955-86 CJ	18040.01
1987-02 WRANGLER	18040.03
1984-01 CHEROKEE	18040.03
1993-98 GRAND CHEROKEE	18040.03
1999-04 GRAND CHEROKEE	18040.04
1974-91 SJ WAGONEER, GRAND WAGONEER, J10, J20	18040.02

STEERING LINKAGE

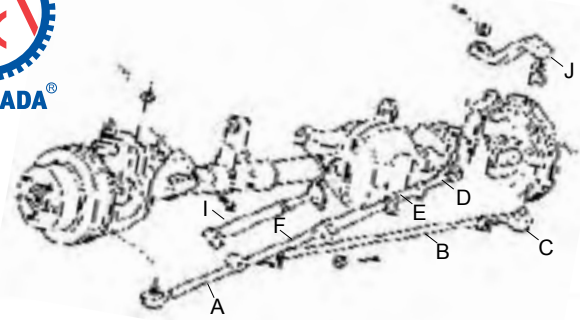
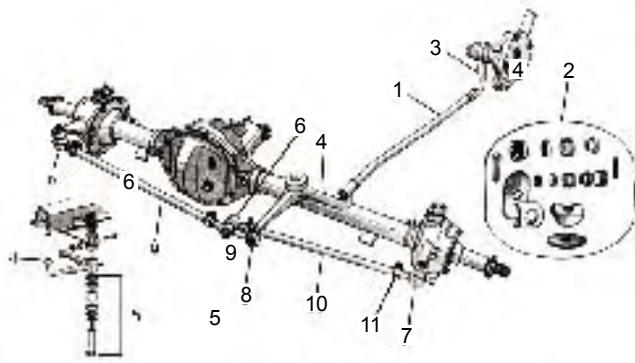

1941-71 MB, M38 & CJ TIE ROD ASSEMBLIES & COMPONENTS

DESCRIPTION	PART #
STEERING DRAG LINKAGE (w/o hardware), MB	18041.03
1 Mid-1948-71 (made after serial # 199080) DRAG LINKAGE W/ HW	18041.01
2 1945-71 4 CYL CJ, H/W KIT FOR DRAG LINKAGE	18041.02
3 1941-71 MB & 4 CYLINDER CJ, PITMAN ARM	18006.30
5 1941-49 MB & CJ, BEFORE S/N 199079, BELLCRANK REPAIR KIT	18042.02
5 1949-66 4 CYL CJ, BELLCRANK REPAIR KIT 7/8"	18042.03
6 1941-71 MB & 4 CYLINDER CJ, RIGHT THREAD TIE ROD END 11/16"	18043.04
6 1950-68 M38 & M38A1, RIGHT TIE ROD END 3/4"	18043.02
7 1941-71 MB & 4 CYLINDER CJ, LEFT THREAD TIE ROD END 11/16"	18043.03
7 1950-71 M38 & M38A1, LEFT THREAD TIE ROD END 3/4"	18043.01
8 1945-71 4 CYLINDER CJ, LEFT THREAD TIE ROD END W/ HOLE	18045.02
8 1950-71 M38 & M38A1, LEFT THREAD TIE ROD END W/ HOLE	18045.01
9 1949-71 4 CYLINDER CJ, TIE ROD ASSY W/ TUBE, RIGHT SIDE, 24.5"	18046.01
10 1949-71 4 CYLINDER CJ, TIE ROD ASSY W/ TUBE, LEFT SIDE, 19.75"	18046.02
11 1945-71 4 CYLINDER CJ, TIE ROD ADJUSTING TUBE CLAMP (4 needed)	18047.01
12 TIE ROD END SPARE BOOT	18048.01

1987-06 WRANGLER TIE ROD ASSY. & COMPONENTS

DESCRIPTION	PART #
A 1987-90 WRANGLER, TIE ROD END	18043.05
A 1991-95 WRANGLER, TIE ROD END	18043.06
A 1997-06 WRANGLER, TIE ROD END	18043.06
B 1987-90 WRANGLER, LONG TUBE DRAG LINK	18050.03
B 1991-95 WRANGLER, LONG TUBE DRAG LINK	18050.04
B 1997-06 WRANGLER, LONG TUBE DRAG LINK	18050.05
C 1987-90 WRANGLER, TIE ROD END	18043.07
C 1991-95 WRANGLER, TIE ROD END	18043.08
C 1997-06 WRANGLER, TIE ROD END	18043.08
D 1987-90 WRANGLER, TIE ROD END	18043.09
D 1991-95 WRANGLER, TIE ROD END	18043.10
D 1997-06 WRANGLER, TIE ROD END	18043.10
E 1987-90 WRANGLER, SHORT SLEEVE	18056.02
E 1991-95 WRANGLER, SHORT SLEEVE	18056.02
E 1997-06 WRANGLER, SHORT SLEEVE	18056.03
F 1987-90 WRANGLER, LONG TIE ROD	18058.03
F 1991-95 WRANGLER, LONG TIE ROD	18058.04
F 1997-06 WRANGLER, LONG TIE ROD	18058.05
G 1987-90 WRANGLER, DRAG LINK KIT (A, B & C)	18052.03
G 1991-95 WRANGLER, DRAG LINK KIT (A, B & C)	18052.04
G 1987-95 WRANGLER, HEAVY DUTY DRAG LINK KIT (UPGRADE)	18050.52
H 1997-06 WRANGLER, DRAG LINK KIT (A, B & C)	18052.05
H 1987-90 WRANGLER, TIE ROD KIT (D, E & F)	18054.03
H 1991-95 WRANGLER, TIE ROD KIT (D, E & F)	18054.04
H 1997-06 WRANGLER, TIE ROD KIT (D, E & F)	18054.05
H 1997-06 WRANGLER, HEAVY DUTY TIE ROD KIT (D, E & F) (UPGRADE)	18050.51
I 1987-90 WRANGLER, STEERING DAMPNER (not shown)	18040.03
I 1991-95 WRANGLER, STEERING DAMPNER (not shown)	18040.03
I 1997-02 WRANGLER, STEERING DAMPNER (not shown)	18040.03
J 1987-90 WRANGLER, PITMAN ARM, LHD (P/S)	18006.03
J 1991-95 WRANGLER, PITMAN ARM, LHD (P/S)	18006.03
J 1997-06 WRANGLER, PITMAN ARM, LHD (P/S)	18006.05
J 1987-90 WRANGLER, PITMAN ARM, LHD (Man.Strg)	18006.04
J 1991-95 WRANGLER, PITMAN ARM, LHD (Man.Strg)	18006.04
J 1997-06 WRANGLER, PITMAN ARM, LHD (Man.Strg)	18006.06

1972-86 CJ TIE ROD ASSEMBLIES & COMPONENTS

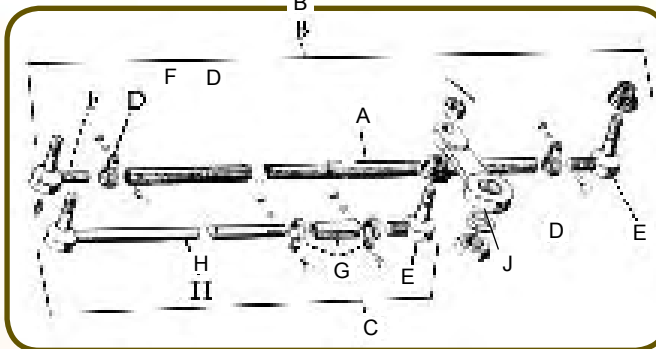

DESCRIPTION	PART #
A 1972-83 CJ5, KNUCKLE TO KNUCKLE, 40.50" TUBE TIE ROD	18050.01
A 1972-83 CJ5, KNUCKLE TO KNUCKLE, 36" HEAVY DUTY TUBE TIE ROD (UPGRADE)	18050.54
A 1972-77 CJ6, KNUCKLE TO KNUCKLE, 36" HEAVY DUTY TUBE TIE ROD (UPGRADE)	18050.54
A 1976-81 CJ7, KNUCKLE TO KNUCKLE, 40.50" TUBE TIE ROD	18050.01
A 1976-81 CJ7, KNUCKLE TO KNUCKLE, 36" HEAVY DUTY TUBE TIE ROD (UPGRADE)	18050.54
A 1981 CJ8, KNUCKLE TO KNUCKLE, 36" HEAVY DUTY TUBE TIE ROD (UPGRADE)	18050.54
A 1981 CJ8, KNUCKLE TO KNUCKLE, 40.50" TUBE TIE ROD	18050.01
A 1982-86 CJ7, KNUCKLE TO KNUCKLE, 43.75" TUBE TIE ROD	18050.02
A 1982-86 CJ8, KNUCKLE TO KNUCKLE, 43.75" TUBE TIE ROD	18050.02

A 1982-86 CJ7, KNUCKLE TO KNUCKLE, 39.25" HEAVY DUTY TUBE TIE ROD (UPGRADE)	18050.53
A 1982-86 CJ8, KNUCKLE TO KNUCKLE, 39.25" HEAVY DUTY TUBE TIE ROD (UPGRADE)	18050.53
B 1972-81 CJ TIE ROD ASSY WITH KNUCKLE TO KNUCKLE, 40.05" TUBE	18052.01
B 1982-86 CJ7, TIE ROD ASSEMBLY WITH KNUCKLE TO KNUCKLE, 43.75" TUBE	18052.02
B 1982-86 CJ8, TIE ROD ASSEMBLY WITH KNUCKLE TO KNUCKLE, 43.75" TUBE	18052.02
C 1972-83 CJ5 TIE ROD ASSY, PITMAN ARM TO STEERING ARM, 28 1/8"	18054.01
C 1972-83 CJ5 HEAVY DUTY TIE ROD ASSY, PITMAN ARM TO STEERING ARM, 20" (UPGRADE)	18050.56
C 1972-77 CJ6 HEAVY DUTY TIE ROD ASSY, PITMAN ARM TO STEERING ARM, 20" (UPGRADE)	18050.56
C 1976-81 CJ7, TIE ROD ASSY, PITMAN ARM TO STEERING ARM, 28 1/8"	18054.01
C 1976-81 CJ7 HEAVY DUTY TIE ROD ASSY, PITMAN ARM TO STEERING ARM, 20" (UPGRADE)	18050.56
C 1976-81 CJ8, TIE ROD ASSY, PITMAN ARM TO STEERING ARM, 28 1/8"	18054.01
C 1976-81 CJ8 HEAVY DUTY TIE ROD ASSY, PITMAN ARM TO STEERING ARM, 20" (UPGRADE)	18050.56
C 1982-86 CJ7, TIE ROD ASSEMBLY, PITMAN ARM TO STEERING ARM, 30.5"	18054.02
C 1982-86 CJ8, TIE ROD ASSEMBLY, PITMAN ARM TO STEERING ARM, 30.5"	18054.02
D 1972-86 CJ, TIE ROD TUBE CLAMP (each)	18047.01
E 1972-86 CJ, RIGHT THREAD TIE ROD END (2 needed)	18043.04
F 1972-86 CJ, LEFT THREAD TIE ROD END (1 needed)	18043.03
G 1972-86 CJ TIE ROD SLEEVE W/ CLAMPS	18056.01
H 1972-83 CJ5, LONG DRAG LINK	18058.01
H 1976-81 CJ7, LONG DRAG LINK	18058.01
H 1982-86 CJ7, LONG TIE ROD	18058.02
H 1982-86 CJ8, LONG TIE ROD	18058.02
J 1976-86 CJ W/ MANUAL STEERING, PITMAN ARM	18006.02
J 1976-86 CJ W/ POWER STEERING, PITMAN ARM	18006.01

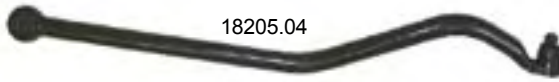
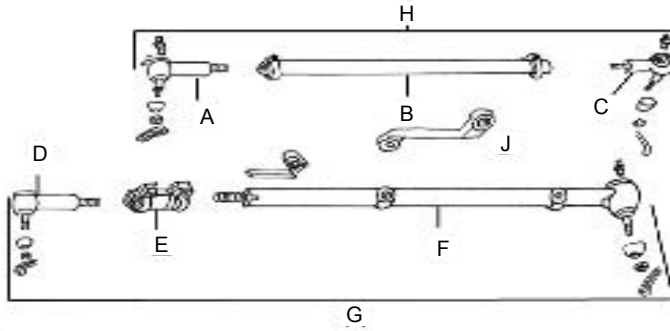

1984-01 CHEROKEE, 1993-98 6 CYL GRAND CHEROKEE TIE ROD ASSYM & COMPONENTS

DESCRIPTION	PART #
1984-90 CHEROKEE TRACK BAR WITH BUSHING (not shown)	18205.03
1991-01 CHEROKEE TRACK BAR WITH BUSHING (WILL ALSO FIT 1997-06 TJ 2004-06 TJ UNLIMITED)	18205.04
1993-98 6 CYLINDER 4.0L GRAND CHEROKEE TRACK BAR W/ BUSHING (WILL ALSO FIT 1997-06 TJ 2004-06 TJ UNLIMITED)	18205.04
1991-01 CHEROKEE ADJUSTABLE TRACK BAR WITH BUSHING (UPGRADE)	18205.05
1993-98 6 CYLINDER 4.0L GRAND CHEROKEE ADJUSTABLE TRACK BAR W/ BUSHING (UPGRADE)	18205.05
A 1984-90 CHEROKEE TIE ROD END	18043.05
A 1991-01 CHEROKEE TIE ROD END	18043.06
A 1993-98 6 CYLINDER 4.0L GRAND CHEROKEE, TIE ROD END	18043.06
B 1984-90 CHEROKEE LONG TUBE DRAG LINK	18050.06
B 1991-01 CHEROKEE LONG TUBE DRAG LINK	18050.06
B 1993-98 6 CYLINDER 4.0L GRAND CHEROKEE LONG TUBE DRAG LINK	18050.05
C 1984-90 CHEROKEE TIE ROD END	18043.07
C 1991-01 CHEROKEE TIE ROD END	18050.07
C 1993-98 6 CYLINDER 4.0L GRAND CHEROKEE TIE ROD END	18043.08
D 1984-90 CHEROKEE TIE ROD END	18043.11
D 1991-01 CHEROKEE TIE ROD END	18043.10
D 1993-98 6 CYLINDER 4.0L GRAND CHEROKEE TIE ROD END	18043.10
E 1984-90 CHEROKEE SHORT SLEEVE	18056.04
E 1991-01 CHEROKEE SHORT SLEEVE	18056.03
E 1993-98 6 CYLINDER 4.0L GRAND CHEROKEE SHORT SLEEVE	18056.03
F 1984-90 CHEROKEE LONG TIE ROD	18058.06
F 1991-01 CHEROKEE LONG TIE ROD	18058.07
F 1993-98 6 CYLINDER 4.0L GRAND CHEROKEE LONG TIE ROD	18058.08
G 1984-90 CHEROKEE TIE ROD KIT (A, B & C) DRAG LINK	18052.06
G 1991-01 CHEROKEE TIE ROD KIT (A, B & C) DRAG LINK	18052.07
G 1993-98 6 CYLINDER 4.0L GRAND CHEROKEE TIE ROD KIT (A, B & C) DRAG LINK	18052.05
H 1984-90 CHEROKEE TIE ROD KIT (D, E & F)	18054.06
H 1991-01 CHEROKEE TIE ROD KIT (D, E & F)	18054.07
H 1993-98 6 CYLINDER 4.0L GRAND CHEROKEE TIE ROD KIT (D, E & F)	18054.08
H 1984-01 CHEROKEE, HEAVY DUTY TIE ROD KIT (UPGRADE)	18050.51
I 1984-90 CHEROKEE STEERING DAMPNER (not shown)	18040.03
I 1991-01 CHEROKEE STEERING DAMPNER (not shown)	18040.03
I 1993-98 6 CYLINDER 4.0L GRAND CHEROKEE STEERING DAMPNER (not shown)	18040.03
J 1984-90 CHEROKEE PITMAN ARM, W/ P/S, LHD	18006.08
J 1991-01 CHEROKEE PITMAN ARM, W/ P/S, LHD	18006.08
J 1993-98 6 CYLINDER 4.0L GRAND CHEROKEE PITMAN ARM, WITH P/S, LHD	18006.09
J 1993-98 6 CYLINDER 4.0L GRAND CHEROKEE PITMAN ARM, WITH MANUAL STEERING, LHD	N/A

LIBERTY TIE ROD COMPONENTS:

DESCRIPTION	PART #
2002-06 LIBERTY, OUTER TIE ROD END, RH	18043.16
2002-06 LIBERTY, OUTER TIE ROD END, LH	18043.17

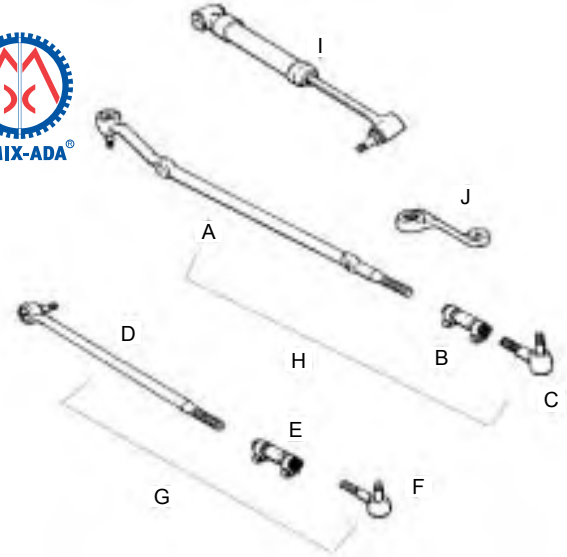

1993-98 V8 (5.2L or 5.9L) GRAND CHEROKEE TIE ROD ASSEMBLIES & COMPONENTS

DESCRIPTION	PART #
A OUTER TO KNUCKLE TIE ROD	18058.09
B SHORT SLEEVE	18056.03
C TIE ROD END	18043.10
D LONG END DRAG LINK	18058.10
E SHORT SLEEVE	18056.03
F TIE ROD	18043.10
G TIE ROD KIT (A + B + C)	18052.08
H HEAVY DUTY TIE ROD KIT (UPGRADE)	18050.51
H ADJUSTABLE TRACK BAR W/ BUSHING (UPGRADE)	18205.05
H DRAG LINK KIT (D + E + F)	18054.09
I STEERING DAMPNER	18040.03
J PITMAN ARM	18006.09

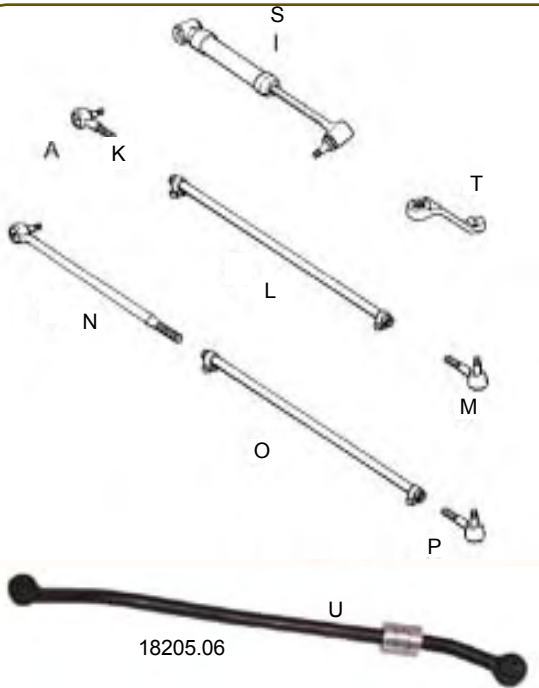

1999-04 GRAND CHEROKEE TIE ROD ASSEMBLIES & COMPONENTS

DESCRIPTION	PART #
K TIE ROD	18043.12
L LONG TUBE DRAG LINK	18050.08
M TIE ROD	18043.13
N TIE ROD	18043.14
O LONG TUBE TIE ROD	18050.09
P TIE ROD	18043.15
Q TIE ROD KIT (A + B + C)	18052.09
R TIE ROD KIT (D + E + F)	18052.10
S STEERING DAMPNER	18040.04
T PITMAN ARM	18006.10
U TRACK BAR	18205.06

SUSPENSION PARTS & ACCESSORIES

1941-71 SUSPENSION



1972-75 SUSPENSION



18270.01

18204.08



4

18270.04



5

10



18201.10

18203.04



18270.05



6



7



8

18270.11



9

18270.12

18270.17

1941-75 STOCK REPLACEMENT LEAF SPRINGS, SHOCKS & COMPONENTS

1 LEAF SPRINGS

DESCRIPTION	PART #
1941-45 MB	18201.01
1941-45 MB	18201.02
1941-45 MB, 9 LAYER REAR	18202.01
1945-53 CJ	18201.01
1945-53 CJ	18201.02
1955-75 CJ5, 7 LAYER FRONT	18201.03
1955-75 CJ5, 9 LAYER REAR	18202.02
1955-75 CJ5, 10 LAYER FRONT	18201.04
1955-75 CJ5 FRONT, 5 LAYER LEAF SPRING ASSY	18201.05
1955-75 CJ6, 7 LAYER FRONT	18201.03
1955-75 CJ6, 10 LAYER FRONT	18201.04
1955-75 CJ6, 9 LAYER REAR	18202.02
1945-53 CJ, 9 LAYER REAR	18202.01
1955-75 CJ, LEAF SPRING ASSEMBLY REAR 5 LEAF	18202.05
1948-63 226 WAGON, 8 LAYER FRONT	18201.01
1948-63 226 WAGON, 10 LAYER FRONT	18201.02
1948-63 226 TRUCK (475) 11 LAYER REAR	18202.03
1948-63 226 WAGON (475) 9 LAYER REAR	18202.04

2 SHOCKS

DESCRIPTION	PART #
1941-45 MB, MONRO-MATIC-PLUS GAS SHOCK	18203.01
1941-45 MB, GAS SHOCK	18203.02
M38, MONRO-MATIC-PLUS GAS SHOCK (front or rear)	18203.01
M38 GAS SHOCK, (front or rear)	18203.02
1941-65 CJ, MONRO-MATIC-PLUS GAS SHOCK	18203.01
1945-65 CJ, GAS SHOCK	18203.02
1953-75 CJ5, MONRO-MATIC-PLUS	18203.01
1953-75 CJ5, GAS SHOCK	18203.02
1955-75 CJ5, MONRO-MATIC-PLUS GAS SHOCK (rear)	18203.04
1955-75 CJ5, GAS SHOCK (rear)	18203.05
1953-75 CJ6, MONRO-MATIC-PLUS	18203.01
1953-75 CJ6, GAS SHOCK	18203.02
1955-75 CJ6, MONRO-MATIC-PLUS GAS SHOCK (rear)	18203.04
1955-75 CJ6, GAS SHOCK (rear)	18203.05
1953-75 4WD WAGON-TRUCK, MONRO-MATIC-PLUS	18203.01
1947-63, MONRO-MATIC-PLUS GAS SHOCK, (front)	18203.01
1953-75 4WD WAGON TRUCK, GAS SHOCK	18203.02
1947-63, GAS SHOCK, (front)	18203.02
1947-62 4WD 226 WAGON & TRUCK	
MONRO-MATIC-PLUS GAS SHOCK (rear)	18203.06
1947-54 2WD WAGON MONRO-MATIC-PLUS SHOCK (pair)	18203.07
1948-51 2WD JEEPSTER, MONRO-MATIC-PLUS SHOCK, (pair)	18203.07

3 U-BOLTS

DESCRIPTION	PART #
1947-71 REAR, ALL MODELS (except: M38 & M38A1) (4 required) U-BOLT	18204.01
1950-71 REAR, M38 & M38A1 (4 required) U-BOLT	18204.02
1941-71 ALL, FRONT, LARGE (1 required) U-BOLT	18204.03
1941-71 ALL, FRONT, SMALL (3 required) U-BOLT	18204.04
1947-63 TRUCK, REAR, (4 required) U-BOLT	18204.05
1941-71 MODELS, LONG NUT FOR LEAF SPRING U-BOLTS	18204.10
1948-63 TRUCK, FRONT LARGE U-BOLT (1 required)	18204.11
1948-63 TRUCK, FRONT SMALL U-BOLT (3 required)	18204.12
1972-75 SPRING U-BOLT (2-9/16" ID)	18204.06
1972-75 SPRING U-BOLT (3-1/4" ID)	18204.07
1972-79 DANA44, SPRING U-BOLT (2-3/4" ID)	18204.08

4 SPRING BOLTS

DESCRIPTION	PART #
1941-45 MB, SPRING BOLT	18270.01
1945-63 CJ, SPRING BOLT	18270.01
1960-75 CJ SPRING BOLT (unthreaded shackles)	18270.02

5 SHACKLE BRACKETS

DESCRIPTION	PART #
1941-45 MB, THREADED SHACKLE BRACKET, FRONT OR REAR	18270.03
1950-68 M38 & M38A1, THREADED SHACKLE BRACKET, FRONT OR REAR	18270.03
1945-68 CJ, THREADED SHACKLE BRACKET, FRONT OR REAR	18270.03
1955-75 CJ UNTHREADED SHACKLE BRACKET	18270.03

6 PIVOT BRACKETS

DESCRIPTION	PART #
1941-45 MB, PIVOT BRACKET	18270.05
1950-68 M38 & M38A1, PIVOT BRACKET	18270.05
1945-68 CJ, PIVOT BRACKET	18270.05
1955-72 CJ5 PIVOT BRACKET	18270.06

7 SPRING PLATES

DESCRIPTION	PART #
1941-71 FRONT PASSENGER SIDE SPRING PLATE	18270.07
1941-71 FRONT DRIVER SIDE SPRING PLATE	18270.08
1941-71 REAR PASSENGER SIDE SPRING PLATE	18270.09
1941-71 REAR DRIVER SIDE SPRING PLATE	18270.10

8 AXLE SNUBBER

DESCRIPTION	PART #
1941-75 RUBBER AXLE SNUBBER, FRONT OR REAR	18270.11

9 SHACKLE KITS

DESCRIPTION	PART #
1941-45 MB, SHACKLE KIT (left hand shackle thread)	18270.12
1941-45 MB, SHACKLE KIT (right hand shackle thread)	18270.13
1950-52 M38, SHACKLE KIT (left hand shackle thread)	18270.12
1950-52 M38, SHACKLE KIT (right hand shackle thread)	18270.13
1953-68 M381 SHACKLE KIT (right hand shackle thread)	18270.14
1945-65 CJ, SHACKLE KIT (left hand shackle thread)	18270.12
1945-65 CJ, SHACKLE KIT (right hand shackle thread)	18270.13
1955-75 CJ, SHACKLE KIT (unthreaded)	18270.15
1955-75 CJ, HEAVY DUTY GREASABLE SHACKLE KIT	18270.16

10 LEAF SPRING BUSHINGS

DESCRIPTION	PART #
1941-53 MB, FRONT LEAF SPRING FRONT EYE (bronze)	18270.17
MB SUSPENSION TORQUE REACTION BUSHING	18270.26
1945 MB, REAR LEAF SPRING FRONT OR REAR EYE (bronze)	18270.17
1950-68 M38, M38A1, FRONT LEAF SPRING FRONT OR REAR EYE (2 per eye)	18270.19
1955-68 M38, M38A1, REAR SPRING FRONT EYE	18270.18
1941-53 CJ, FRONT LEAF SPRING FRONT EYE (bronze)	18270.17
1953-68 CJ, FRONT LEAF SPRING FRONT OR REAR EYE (rubber/steel)	18270.18
1955-75 CJ, REAR LEAF SPRING FRONT OR REAR EYE (rubber/steel)	18270.18
1945-49 CJ2A, REAR LEAF SPRING FRONT OR REAR EYE (bronze)	18270.17
1948-53 CJ3A, REAR LEAF SPRING FRONT OR REAR EYE (bronze)	18270.17
1953-63 CJ3B, REAR LEAF SPRING FRONT OR REAR EYE (bronze)	18270.17
1946-63 WILLYS 226, REAR LEAF SPRING BRONZE BUSHING	18270.27

11 PIVOT BOLTS

DESCRIPTION	PART #
MB SUSPENSION PIVOT BOLT W/ NUT (torque reaction spring to shackle)	18270.24
MB SUSPENSION PIVOT BOLT W/ NUT (front spring to shackle)	18270.25

Note: See suspension related safety warning at front of catalog.

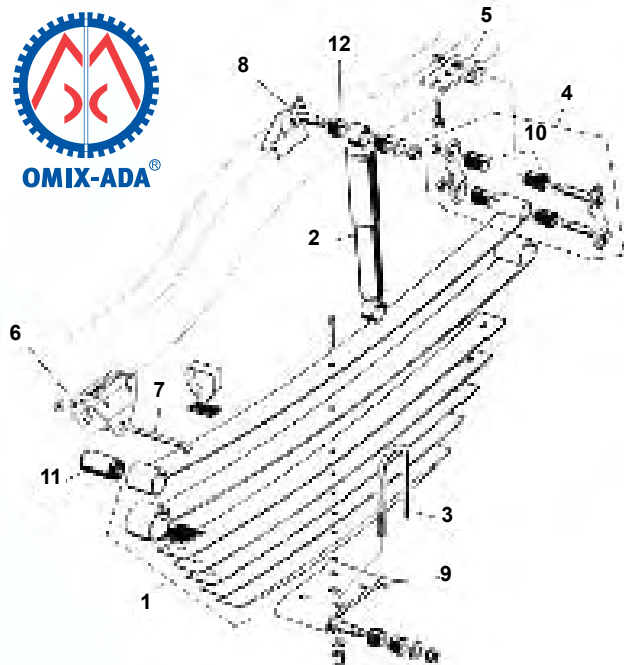

1976-86 CJ STOCK REPLACEMENT LEAF SPRINGS, SHOCKS & COMPONENTS

DESCRIPTION	PART #
1 1976-86 4 LAYER CJ, FRONT	18201.10
1 1976-86 6 LAYER CJ, FRONT	18201.11
1 1976-86 8 LAYER CJ, FRONT	18201.12
1 1976-86 4 LAYER CJ, REAR	18202.10
1 1976-86 6 LAYER CJ, REAR	18202.11
2 1976-81 MONRO-MATIC-PLUS GAS SHOCK (front)	18203.01
2 1976-81 GAS SHOCK (front)	18203.02
2 1982-86 MONRO-MATIC PLUS GAS SHOCK (front)	18203.08
2 1982-86 GAS SHOCK (front)	18203.09
2 1976-86 MONRO-MATIC-PLUS GAS SHOCK (rear)	18203.04
2 1976-86 GAS SHOCK (rear)	18203.05
3 1976-86 SPRING U-BOLT (2-9/16" ID) (rear)	
AMC-20, FRONT DANA-30 AXLES	18204.06
3 1976-86 SPRING U-BOLT (3-1/4" ID), FRONT DANA-30 AXLE (large U-bolt)	18204.07
3 1976-86 SPRING U-BOLT (2-3/4" ID), REAR DANA-44 AXLE	18204.08
4 1976-86 CJ, SHACKLE KIT WITH BUSHINGS, FRONT SPRING	18271.01
4 1976-86 CJ, SHACKLE KIT WITH BUSHINGS, REAR SPRING	18271.02
5 1976-86 SHACKLE END SPRING HANGER (rear)	18271.03
5 1976-86 SHACKLE END SPRING HANGER (front)	18271.04
6 1976-86 MAIN EYE SPRING HANGER (front or rear)	18271.05
7 1976-86 LEAF SPRING EYE BOLT (front or rear)	18271.06
7A 1976-86 RUBBER AXLE SNUBBER (front or rear)	18271.07
7B 1976-86 SWAY-BAR LINK WITH BUSHING, LEFT OR RIGHT (front)	18271.08
7C 1976-86 SWAY BAR BUSHING, 7/8" (front)	18271.09
8 1976-81 SHOCK MOUNT BRACKET (with narrow trac axles) (front)	18271.10
9 1976-86 LEAF SPRING MOUNT KIT (8 U-bolts for both AMC-20 & DANA-44 incl) (rear)	18271.11
9 1976-86 DRIVER SIDE SPRING PLATE (rear)	18271.12
9 1976-86 LEAF SPRING MOUNT KIT (front)	18271.13
9 1976-86 PASSENGER SIDE SPRING PLATE (rear)	18271.14
9 1976-86 DRIVER SIDE SPRING PLATE (front)	18271.15
9 1976-86 PASSENGER SIDE SPRING PLATE (front)	18271.16
10 1976-86 CJ, LEAF SPRING FT EYE (2/eye) (front)	18271.17
10 1976-86 CJ, LEAF SPRING FT EYE (main eye) (rear)	18271.19
11 1976-86 CJ, LEAF SPRING REAR EYE (main eye) (ft)	18271.18
11 1976-86 CJ, LEAF SPRING REAR EYE (2/eye) (rear)	18271.20
12 SHOCK GROMMET (need 4 per shock)	18270.20

1997-06 WRANGLER REPLACEMENT COIL SPRINGS, SHOCKS & COMPONENTS

DESCRIPTION	PART #
MONRO-MATIC-PLUS GAS SHOCK, FRONT	18203.30
SENSA-TRAC HEAVY DUTY GAS SHOCK, FRONT	18203.31
MONRO-MATIC-PLUS GAS SHOCK, REAR	18203.32
SENSA-TRAC HEAVY DUTY GAS SHOCK, REAR	18203.33
1997-06 WRANGLER FRONT COIL SPRING EACH	18274.01
1997-06 WRANGLER REAR COIL SPRING EACH	18274.02
1997-06 FRONT UPPER ARM (INCLUDES BUSHING)	18280.01
1997-06 WRANGLER REAR SUSPENSION UPPER CONTROL ARM	18282.04
1997-06 WRANGLER HEAVY DUTY FRONT LOWER CONTROL ARM AXLE MOUNT (pair)	18273.01

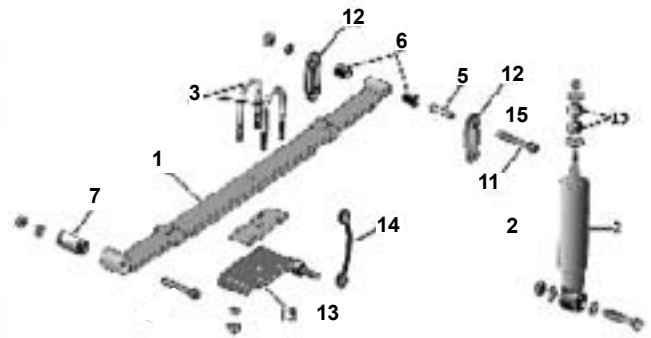

1987-95 WRANGLER REPLACEMENT LEAF SPRINGS, SHOCKS & COMPONENTS

DESCRIPTION	PART #
TRACK BAR, FRONT	18205.01
TRACK BAR, REAR	18205.02
4 LAYER WRANGLER FRONT	18201.20
6 LAYER WRANGLER REAR	18202.22
5 LAYER WRANGLER REAR	18201.23
1 MONRO-MATIC-PLUS GAS SHOCK, FRONT	18203.20
2 SENSA-TRAC HEAVY DUTY GAS SHOCK, FRONT	18203.21
2 MONRO-MATIC-PLUS GAS SHOCK, REAR	18203.22
2 SENSA-TRAC HEAVY DUTY GAS SHOCK, REAR	18203.23
3 SPRING U-BOLT WITH HARDWARE (2-9/16" ID) DANA-35 REAR, DANA-30 FRONT	18204.06
3 SPRING U-BOLT WITH HARDWARE (3-1/4" ID) DANA-30 FRONT	18204.07
3 SPRING U-BOLT WITH HARDWARE (2-3/4" ID) DANA-44 REAR	18204.08
4 LEAF SPRING MAIN EYE BOLT, FRONT OR REAR	18271.06
5 FRONT OR REAR BUSHING SPACER	18272.01
6 FRONT LEAF SPRING FRONT EYE (2 per eye)	18272.02
6 FRONT LEAF SPRING FRONT EYE (2 per eye) CLEVITE BRAND	18272.14
6 FRONT LEAF SPRING REAR EYE (main eye)	18271.19
6 FRONT LEAF SPRING REAR EYE (main eye) CLEVITE BRAND	18207.08
7 REAR LEAF SPRING FRONT EYE (main eye)	18271.19
7 REAR LEAF SPRING FRONT EYE (main eye) CLEVITE BRAND	18207.08
7 REAR LEAF SPRING REAR EYE (2 per eye)	18272.02
8 SWAYBAR CUSHION, FRONT SPRING	18272.03
9 AXLE SNUBBER, FRONT	18272.04
9 AXLE SNUBBER, REAR	18272.05
12 SHACKLE SIDE PLATE, FRONT OR REAR (need 8)	18272.08
13 SPRING PLATE, FRONT PASSENGER SIDE	18272.09
13 SPRING PLATE, FRONT DRIVER SIDE	18272.11
13 SPRING PLATE, REAR PASS. OR DRIVER SIDE	18272.10
14 SWAY BAR LINK, FRONT (inc. bushings) RH=LH	18272.12
15 SHOCK GROMMET	18272.13



18206.01

DEGREE WEDGES

DESCRIPTION	PART #
1976-86 CJ & 1987-95 WRANGLER, CAST ALUMINUM, 6 DEGREE (for pinion angle)	18206.01
1976-86 CJ & 1987-95 WRANGLER CAST ALUMINUM, 8 DEGREE (for pinion angle)	18206.02

MISC. SUSPENSION PARTS

DESCRIPTION	PART #
1973-74 DJ5C POSTAL, KING BOLT SET (half set for 1 side)	18284.01
1978-91 DJ POSTAL SPRING BUSHING	18284.02
1978-91 SJ WAGONEER SPRING BUSHING	18284.03
1978-91 SJ WAGONEER SPRING BUSHING	18284.04



← 18273.01

SUSPENSION PARTS & ACCESSORIES

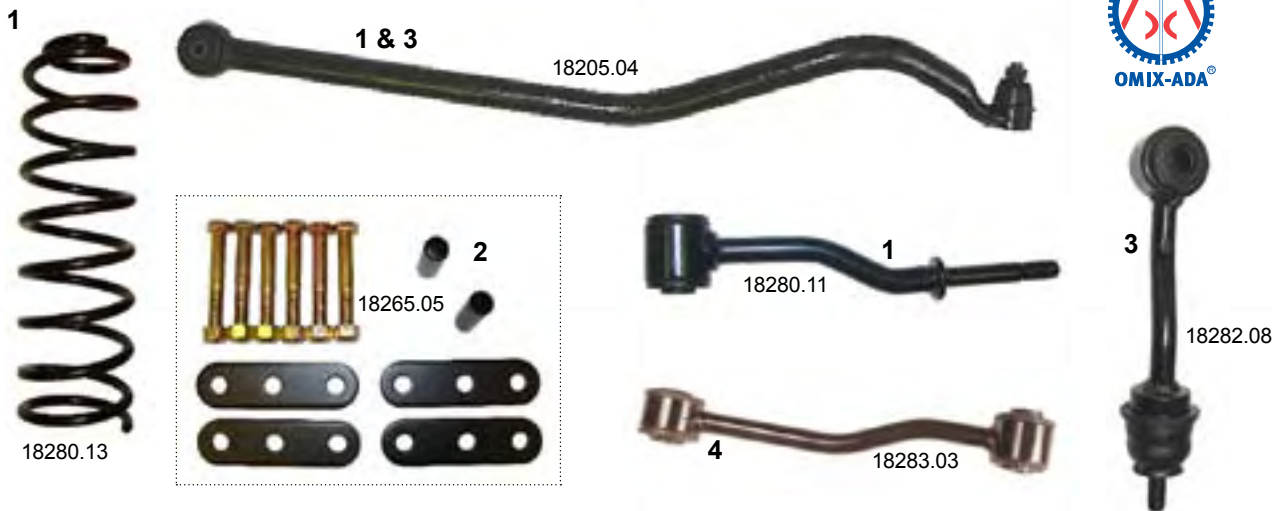

1 1984-01 CHEROKEE REPLACEMENT SUSPENSION COMPONENTS

DESCRIPTION	PART #
1984-90 MONRO-MATIC-PLUS GAS SHOCK, FRONT	18203.50
1991-01 MONRO-MATIC-PLUS GAS SHOCK, FRONT	18203.51
1984-01 MONRO-MATIC PLUS GAS SHOCK, REAR	18203.52
1984-01 SHOCK GROMMET	18272.13
1991-01 FRONT UPPER ARM (INCLUDES BUSHING)	18280.01
1984-90 FRONT OR REAR BUSHING FOR FRONT UPPER ARM	18280.03
1984-90 FRONT OR REAR BUSHING FOR FRONT UPPER ARM, CLEVITE BRAND	18207.01
1991-01 FRONT OR REAR BUSHING FOR FRONT UPPER ARM	18280.04
1991-01 FRONT OR REAR BUSHING FOR FRONT UPPER ARM, CLEVITE BRAND	18207.03
1984-01 FRONT LOWER ARM (includes bushing)	18280.05
1984-01 FRONT OR REAR BUSHING FOR FRONT LOWER ARM	18280.06
1984-01 FRONT OR REAR BUSHING FOR FRONT LOWER ARM, CLEVITE BRAND	18207.02
1984-01 REAR LEAF SPRING FRONT EYE BUSHING	18280.07
1984-01 REAR LEAF SPRING REAR EYE BUSHING	18280.08
1984-01 REAR AXLE BUMPER	18280.09
1984-01 REAR SPRING SWAY BAR CUSHION	18280.10
1991-01 SWAY BAR LINK	18280.11
1984-01 SWAY BAR LINK BUSHING	18280.12
1984-90 FRONT TRACK BAR (WITH BUSHING)	18205.03
1991-01 FRONT TRACK BAR (WITH BUSHING)	18205.04
1984-01 ADJUSTABLE FRONT TRACK BAR (W/ BUSHING) (UPGRADE)	18205.05
1984-01 FRONT COIL SPRING (EACH) LIGHT DUTY	18280.13
1984-89 BUSHING STABILIZER, ORANGE	18280.14
1984-89 BUSHING STABILIZER, BROWN	18280.15
1984-01 ISOLATOR, FRONT	18205.16
1984-01 REAR LEAF SPRING, HEAVY DUTY	18280.17
1994-01 FRONT CUSHION	18280.18
1984-01 BUSHING SWAY BAR	18280.10

2 OMIX'S HEAVY DUTY SHACKLES (sold in pairs)

DESCRIPTION	PART #
1955-75 CJ, FRONT OR REAR, W/O BUSHINGS	18265.01
1955-75, GREASABLE FRONT OR REAR, W/O BUSHING	18265.02
1955-75, GREASABLE FRT OR REAR, W/ BLACK BUSHING	18265.03
1955-75, GREASABLE FRONT OR REAR, W/ RED BUSHING	18265.04
1976-86 CJ, FRONT, W/O BUSHINGS	18265.05
1976-86 CJ, REAR, W/O BUSHINGS	18265.09
1976-86 CJ, GREASABLE, FRONT, W/O BUSHINGS	18265.06
1976-86 CJ, GREASABLE, REAR, W/O BUSHINGS	18265.10
1976-86 CJ, GREASABLE, FRONT, W/ BLACK BUSHINGS	18265.07
1976-86 CJ, GREASABLE, REAR, W/ BLACK BUSHINGS	18265.11
1976-86 CJ, GREASABLE, FRONT, W/ RED BUSHINGS	18265.08
1976-86 CJ, GREASABLE, REAR, W/ RED BUSHINGS	18265.12
1987-95 WRANGLER, FRONT W/O BUSHINGS	18265.13*
1987-95 WRANGLER, REAR W/O BUSHINGS	18265.17*
1987-95 WRANGLER, GREASABLE FRONT W/O BUSHINGS	18265.14*
1987-95 WRANGLER, GREASABLE REAR W/O BUSHINGS	18265.18*
1987-95 WRANGLER, GREASABLE FRONT WITH BLACK BUSHINGS	18265.15*
1987-95 WRANGLER, GREASABLE REAR WITH BLACK BUSHINGS	18265.19*
1987-95 WRANGLER, GREASABLE FRONT WITH RED BUSHINGS	18265.16*
1987-95 WRANGLER, GREASABLE REAR WITH RED BUSHINGS	18265.20*

*THESE SHACKLES WILL PROVIDE 1" LIFT TO WRANGLER

3 1993-98 GRAND CHEROKEE REPLACEMENT SUSPENSION COMPONENTS

DESCRIPTION	PART #
MONRO-MATIC-PLUS GAS SHOCK (models without Up Country option) FRONT	18203.60
SPECIAL SHOCK PAIR (models with Up Country option) FRONT	18203.61
MONRO-MATIC-PLUS GAS SHOCK (models with Up Country option) REAR	18203.62
SPECIAL SHOCK PAIR (models with Up Country option) REAR	18203.63
1993-98 FRONT UPPER ARM (includes bushing)	18280.02
1993-98 FRONT OR REAR BUSHING FOR FRONT UPPER ARM	18282.01
1993-98 FRONT LOWER ARM (includes bushing)	18280.05
1993-98 FRONT BUSHING FOR FRONT LOWER ARM, CLEVITE BRAND	18282.02
1993-98 REAR BUSHING FOR FRONT LOWER ARM	18207.04
1993-98 REAR BUSHING FOR FRONT LOWER ARM, CLEVITE BRAND	18282.03
1993-98 REAR UPPER ARM (includes bushing)	18207.07
1993-98 FRONT OR REAR BUSHING FOR REAR UPPER ARM	18282.04
1993-98 FRONT OR REAR BUSHING FOR REAR UPPER ARM, CLEVITE BRAND	18282.05
1993-98 REAR LOWER ARM (includes bushing)	18207.05
1993-98 FRONT OR REAR BUSHING FOR REAR LOWER ARM	18282.06
1993-98 FRONT OR REAR BUSHING FOR REAR LOWER ARM, CLEVITE BRAND	18282.07
1993-96 FRONT SWAY BAR LINK	18207.06
1997-98 FRONT SWAY BAR LINK	18280.11
1993-98 FRONT SWAY BAR LINK GROMMET	18282.08
1993-98 FRONT TRACK BAR	18280.12
1993-98 ADJUSTABLE FRONT TRACK BAR (WITH BUSHING) (UPGRADE)	18205.04
1994-98 FRONT COIL SPRING, HEAVY DUTY	18205.05
1993-98 REAR COIL SPRING	18282.10
	18282.11

4 1999-04 GRAND CHEROKEE REPLACEMENT SUSPENSION COMPONENTS

DESCRIPTION	PART #
MONRO-MATIC-PLUS SHOCK (models without Up Country option), FRONT	18203.67
MONRO-MATIC-PLUS SHOCK (models without Up Country option), REAR	18203.68
TRACK BAR	18205.06
FRONT COIL SPRING	18283.01
REAR COIL SPRING	18283.02
FRONT STABILIZER LINK	18283.03
REAR STABILIZER LINK	18283.04
FRONT SWAY BAR BUSHING	18283.09
REAR SWAY BAR BUSHING	18283.08
BUSHING REAR UPPER CONTROL ARM	18283.05
BUSHING FRONT OR REAR LOWER CONTROL ARM	18283.06
BUSHING, FRONT UPPER ARM	18283.07

5 2002-06 LIBERTY REPLACEMENT SUSPENSION COMPONENTS

DESCRIPTION	PART #
BUSHING REAR UPPER CONTROL ARM	18283.05

DANA18 & BORG-WARNER QUADRATRAC

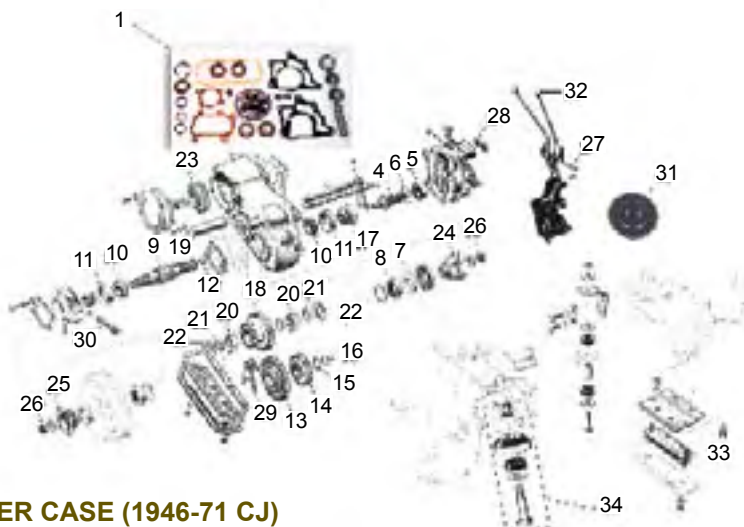

DANA 18 TRANSFER CASE (1946-71 CJ)

DESCRIPTION	PART #	DESCRIPTION	PART #
1 OVERHAUL REPAIR KIT (includes: front & rear bearings & cups, front ball bearing, gaskets & oils seals kit, needle bearings & small parts kits) WITH 1-1/8" INTERMEDIATE GEAR SHAFT WITH 1-1/4" INTERMEDIATE GEAR SHAFT	18601.01 18601.02	18 INTERMEDIATE GEAR: 39X18 TEETH COUNT (MARK 18-5-9)	18670.17
2 COMPLETE ASSEMBLED DANA-18 TRANSFER CASE (includes dual shifter kit, all 4 cylinders w/ 3 speed trans, features 1-1/4" intermediate shaft which is stronger than stock)	18602.01	19 SHAFT, INTERMEDIATE GEAR 3/4"	18604.01
3 GASKETS, OIL SEALS & FELTS KIT	18603.01	19 SHAFT, INTERMEDIATE GEAR 1-1/8"	18604.02
5 BALL BEARING, FRONT OUTPUT SHAFT	18670.01	19 SHAFT, INTERMEDIATE GEAR 1-1/4"	18604.03
6 SNAP RING, FRONT OUTPUT SHAFT BEARING	18670.02	19 SHAFT, INTERMEDIATE GEAR 1-1/8"	18604.04
7 FELT FRONT OR REAR YOKE (2 NEEDED)	18670.03	19A SHAFT, NEEDLES & WASHER KIT	18605.01
8 OIL SEAL, FRONT OR REAR YOKE (2 NEEDED)	18670.04	19A SHAFT, NEEDLES & WASHER KIT	18605.03
9 REAR OUTPUT SHAFT	18670.05	20 ROLLER BEARING, INTERMEDIATE GEAR SHAFT: WITH 3/4" SHAFT (cage bearing, 2 needed)	18670.18
10 BEARING CONE, FRONT OR REAR OUTPUT SHAFT (NEED 2)	18670.06	WITH 1-1/8" SHAFT (cage bearing, 2 needed)	18670.19
11 BEARING CUP, FRONT & REAR OUTPUT SHAFT (NEED 2)	18670.07	WITH 1-1/4" SHAFT (needle bearing, 48 needed)	18670.20
12 BUSHING, FRONT OUTPUT SHAFT	18670.08	21 SPACER, INTERMEDIATE GEAR SHAFT	18670.21
13 FRONT OUTPUT SHAFT SLIDING GEAR: 33 TEETH COUNT (MARK 18-8-22)	18670.10	22 THRUST WASHER, INTERMEDIATE SHAFT: FOR 3/4" SHAFT (2 needed)	18670.22
14 FRONT OUTPUT SHAFT GEAR: 29 TEETH COUNT (MARK 18-8-24)	18670.12	FOR 1-1/8" SHAFT (2 needed)	18670.23
15 THRUST WASHER, FRONT OUTPUT SHAFT GEAR	18670.13	FOR 1-1/4" SHAFT (2 needed)	18670.24
16 SNAP RING, FRONT OUTPUT SHAFT GEAR	18670.14	23 MAIN SHAFT GEAR, 29 TEETH, 6 SPLINE	18670.25
17 OUTPUT SHAFT HUB	18670.15	24 FRONT YOKE	16580.01
		25 YOKE, REAR (MB, 2A, 3A, 3B, M38, M38A1)	18670.27
		26 NUT FOR FRONT OR REAR YOKE, 41-46 (2 needed) (NEW)	16584.12
		26 NUT FOR FRONT OR REAR YOKE, 47-71 (2 needed)	16584.01
		27 SHIFT LEVER PIVOT PIN	18670.29
		28 SHIFT ROD OIL SEAL (2 needed)	18670.30
		29 SHIFT FORK	18670.31
		31 SHIFTER BOOT, DUAL LEVER	18606.01
		32 SHIFT KNOB (each)	18607.01
		33 TRANSFER CASE MOUNT	18608.01
		34 REAR MOUNT SUPPORT KIT BOLT & INSULATORS WASHER FOR TRANSFER CASE SNUBBER, CJ	18608.15 18670.32

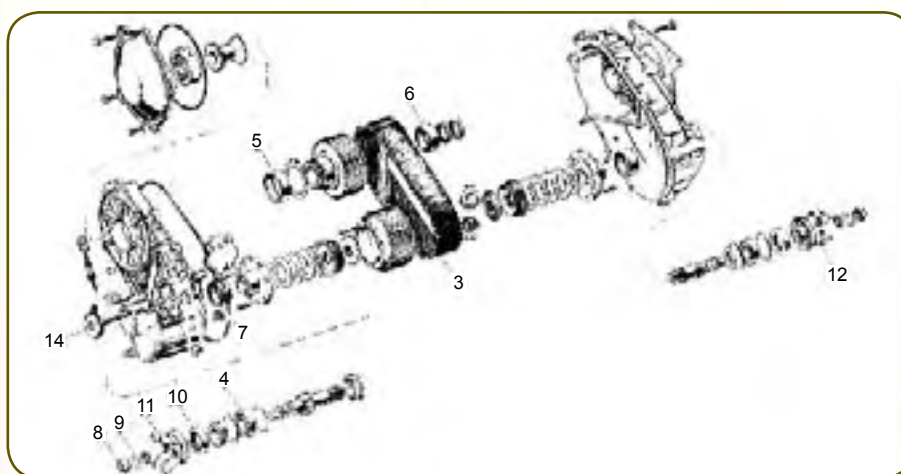

BORG-WARNER QUADRATRAC TRANSFER CASE 1976-79 CJ7 W/ AUTOMATIC TRANSMISSION

DESCRIPTION	PART #	DESCRIPTION	PART #
2 RTV SILICON TO BE USED AS GASKET	19201.01	7 BEARING, FRNT & REAR LOWER SPROCKET (2 needed)	18678.03
3 DRIVE CHAIN REPLACEMENT FOR FACTORY CHAIN REPLACEMENT FOR OVERDRIVE PART-TIME CONVERSION KIT	18612.08	8 NUT FOR FRONT OR REAR YOKE (2 needed)	16584.01
5 BEARING, REAR UPPER SPROCKET	18612.09	9 WASHER FOR FRONT OR REAR YOKE (2 needed)	16584.02
6 BEARING, FRONT UPPER SPROCKET	18678.03	10 OIL SEAL, FRONT OR REAR YOKE (2 needed)	18670.04
		11 YOKE, REAR OUTPUT, 10 SPLINE	16580.01
		12 YOKE, FRONT OUTPUT, 10 SPLINE	18678.04
		12 YOKE, FRONT OUTPUT, 26 SPLINE	18678.05
		13 U-BOLT, (use one pair per yoke)	16582.01
		13 U-BOLT, (use one pair per yoke) SPICER BRAND	16582.02

1972-79 CJ DANA 20

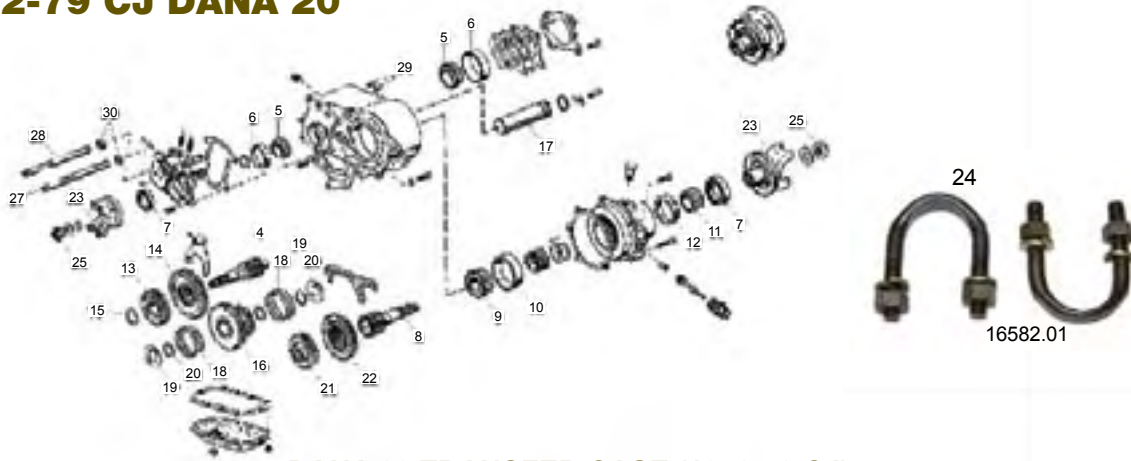

DANA 20 TRANSFER CASE (1972-79 CJ)

DESCRIPTION	PART #	DESCRIPTION	PART #
1 OVERHAUL KIT (includes 3 front & rear bearings & cups, gaskets & oil seals kit & small parts kits)	18601.03	19 SPACER, INTERMEDIATE GEAR SHAFT	18670.21
3 GASKETS & OIL SEALS KIT	18603.02	20 THRUST WASHER, INTERMEDIATE SHAFT	18670.24
5 BEARING CONE, FRONT OUTPUT SHAFT (2 needed)	18672.02	23 FRONT OR REAR YOKE (2 needed):	
6 BEARING CUP, FRONT OUT PUT SHAFT (2 needed)	18670.07	10 SPLINE	16580.01
7 OIL SEAL, FRONT OR REAR YOKE (2 needed)	18670.04	26 SPLINE (U-bolt design)	16580.02
9 BEARING CONE, INNER REAR OUTPUT SHAFT	16536.01	24 U-BOLT FOR ABOVE YOKES (pair)	16582.01
10 BEARING CUP, INNER REAR OUTPUT SHAFT	16536.02	24 U-BOLT FOR ABOVE YOKES (pair) SPICER BRAND	16582.02
11 BEARING CONE, OUTER REAR OUTPUT SHAFT	18672.06	25 NUT FOR FRONT OR REAR YOKE (2 needed)	16584.01
12 BEARING CUP, OUTER REAR OUTPUT SHAFT	18672.07	26 SHIFT KNOB W/ SHIFT PATTERN	18607.02
13 FRONT OUTPUT SHAFT GEAR:		29 SHIFT ROD CAP COVER	18672.17
29 TEETH COUNT (mark 18-8-24 or 18-8-64)	18670.12	30 SHIFT ROD OIL SEAL (2 needed)	18670.30
14 OUTPUT SHAFT SLIDING GEAR:		31 SHIFTER BOOT, 1972-75	18606.02
31 TEETH COUNT (mark 18-8-28)	18672.09	31 SHIFTER BOOT, 1976-79	18606.03
33 TEETH COUNT (mark 18-8-22)	18670.10	32 TRANSFER CASE MOUNT	18608.02
15 THRUST WASHER, FRONT OUTPUT SHAFT GEAR	18672.10	32 POLYURETHANE MOUNT, RED	18392.01
16 INTERMEDIATE GEAR:		32 POLYURETHANE MOUNT, BLACK	18608.04
39X18 TEETH COUNT (mark 18-5-9)	18670.17	33 STABILIZER STUD, TRANSMISSION MOUNT	18608.05
34X20 TEETH COUNT (mark 18-5-10) LTD. AVAIL.	18672.11	34 STABILIZER BUSHING (2 needed)	18608.06
17 SHAFT, INTERMEDIATE GEAR	18604.03	34 POLYURETHANE STABILIZER BUSHING, RED (pair)	18369.01
17A SHAFT, NEEDLES & WASHER KIT	18605.01	34 POLYURETHANE STABILIZER BUSHING, BLACK (pair)	18608.08
18 NEEDLE ROLLER BEARING, (48 needed)	18670.20		

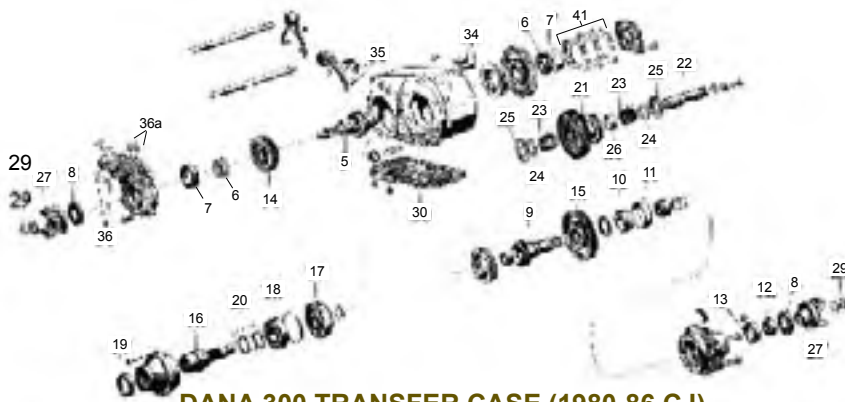

DANA 300 TRANSFER CASE (1980-86 CJ)

DESCRIPTION	PART #	DESCRIPTION	PART #
1 TWIN STICK SHIFTER ASSEMBLY	18674.01	27 FRONT OR REAR YOKE (2 needed):	
2 BOOT FOR TWIN STICK SHIFT	18606.06	STOCK STRAP & BOLT DESIGN	16580.03
3 GASKETS & OIL SEALS KIT	18603.03	MODIFIED U-BOLT DESIGN	16580.02
4 RTV SILICONE TUBE (to be used as gasket)	19201.01	28 U-BOLT:	
5 FRONT OUTPUT SHAFT (26 spline)	18674.08	STRAP & BOLT DESIGN (for 16580.03)	16582.03
6 BEARING CONE, FRONT OUTPUT SHAFT (2 needed)	18674.09	U-BOLT DESIGN (pair, per yoke) (for 16580.02)	16582.01
7 BEARING CUP, FRONT OUTPUT SHAFT (2 needed)	18674.10	U-BOLT DESIGN (pr/yoke) (for 16580.02) - SPICER	16582.02
8 OIL SEAL, FRONT OR REAR YOKE (2 needed)	18674.11	29 NUT FOR FRONT OR REAR YOKE (2 needed)	16584.01
9 REAR OUTPUT SHAFT	18674.12	31 SHIFT KNOB (w/o shift pattern plate)	18607.03
10 BEARING CONE, INNER REAR OUTPUT SHAFT	18674.13	32 SHIFT PATTERN PLATE (for above shift knob)	18607.04
11 BEARING CUP, INNER REAR OUTPUT SHAFT	16536.02	33 SHIFT KNOB LOCK NUT	18607.05
12 BEARING CONE, OUTER REAR OUTPUT SHAFT	18672.06	34 SHIFT ROD CAP COVER	18672.17
13 BEARING CUP, OUTER REAR OUTPUT SHAFT	18672.07	35 SHIFT FORK PLASTIC INSERT (2 needed)	18674.24
14 FRONT OUTPUT SHAFT GEAR	18674.14	36 SHIFT ROD OIL SEAL (2 needed)	18674.25
16 INPUT SHAFT	18674.16	36a SHIFT ROD SPRING (2 needed)	18674.36
17 INPUT SHAFT GEAR	18674.17	37 SHIFTER BOOT W/ SR4, T4, T5 TRANS (single nipple)	18606.04
18 INPUT SHAFT BEARING	18674.18	37 SHIFTER BOOT W/ T176, T177 TRANS (double nipple)	18606.05
19 INPUT SHAFT OIL SEAL	18674.19	38 TRANSFER CASE MOUNT	18608.02
20 INPUT SHAFT SHIM KIT	18674.20	38 POLYURETHANE MOUNT, RED	18608.03
22 SHAFT, INTERMEDIATE GEAR	18604.03	38 POLYURETHANE MOUNT, BLACK	18608.04
22A SHAFT, NEEDLES & WASHER KIT	18605.01	39 STABILIZER STUD, TRANSMISSION MOUNT	18608.05
23 NEEDLE ROLLER BEARING (48 needed)	18670.20	40 STABILIZER BUSHING (2 needed)	18608.06
24 SPACER, INTERMEDIATE GEAR SHAFT (2 needed)	18670.21	40 POLYURETHANE STABILIZER BUSHING PAIR, RED	18608.07
25 THRUST WASHER, INTERMEDIATE SHAFT (2 needed)	18670.24	40 POLYURETHANE STABILIZER BUSHING PAIR, BLACK	18608.08
26 SPACER, INTERMEDIATE SHAFT BEARING	18674.22	41 SHIM SET (8 pcs)	18674.26
		SHIFTER LEVER	18674.27
		SHIFTER SHAFT	18674.28

MISCELLANEOUS TRANSFER CASE PARTS

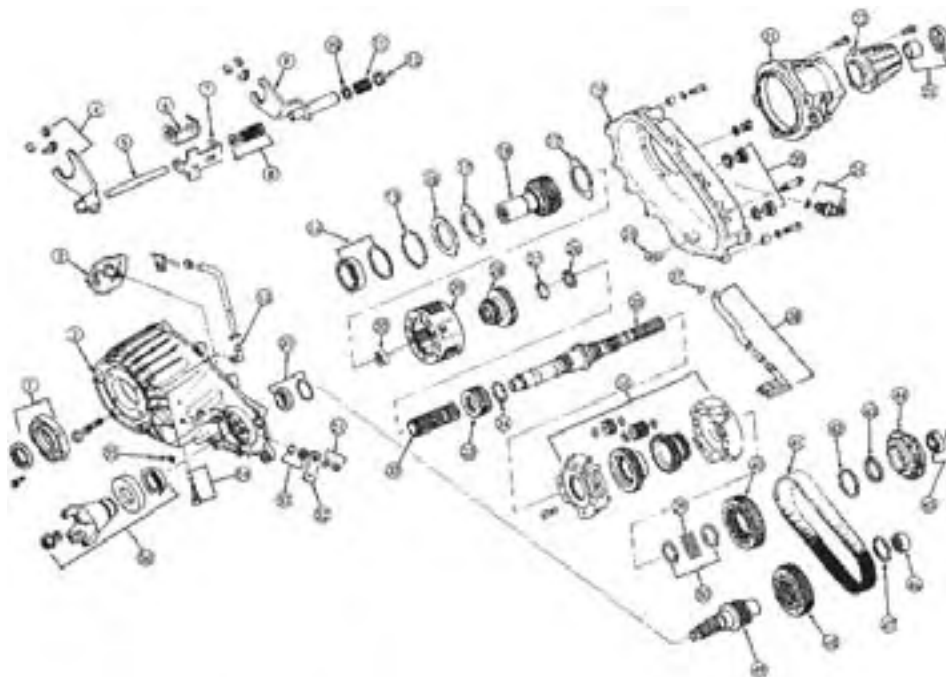

1987-02 NP242

DESCRIPTION	PART #
INPUT BEARING RETAINER (NEW)	18680.11
INPUT BEARING RETAINER SEAL (NEW)	18680.13
RANGE SHIFT FORK (NEW)	18680.17
RANGE SHIFT FORK PAD (NEW)	18680.27
CENTER RANGE SHIFT FORK PAD (NEW)	18680.26
MODE SHIFT FORK PAD (NEW)	18680.25
INPUT GEAR (NEW)	18680.10
REAR CASE (NEW)	18680.05
VACUUM SWITCH SEAL, 1987-93 WRANGLER (NEW)	18680.15
RANGE SLEEVE (NEW)	18680.18
PLANETARY GEAR (NEW)	18680.55
MAIN SHAFT (NEW)	18680.45
OIL TUBE O-RING (NEW)	18680.36
OIL FILTER (NEW)	18680.35
DRIVE SPROCKET (NEW)	18680.16
OUTPUT SHAFT BEARING (NEW)	18680.48
SHIFT LEVER BUSHING (NEW)	18680.19
FRONT OUTPUT YOKE WASHER (NEW)	18680.32
FRONT YOKE (NEW)	18680.30
FRONT YOKE NUT (NEW)	18680.31
CASE HOUSING COVER REAR NP242 93-99 XJ, 93-98 ZJ, 99-04 WJ	18680.05 18680.05

MISCELLANEOUS TRANSFER CASE PARTS

DESCRIPTION	PART #
MODE RANGE SHIFT FORK NP208	
80-83 FULL SIZE CHEROKEE, 80-86 J-TRUCK	18679.23
FRONT OUTPUT SHAFT BEARING SNAP RING NP208	18679.39
INPUT GEAR NV247 XJ 94-01, ZJ 97-98, WJ 99-04	18680.10
YOKE NUT FRONT NV241, NV247 TJ 03-06, XJ 87-01, KJ 02-07, ZJ 97-98, WJ 99-04	18680.31
FRONT OUTPUT SHAFT BEARING NV247, XJ 87-00, ZJ 93-98, WJ 99-04, KJ 02-07, WK 08 21DGQ, KJ 02-07 45RF & 42RL, ZJ 97-98 42RE, 44RE	18680.48

1993-98 NV249

DESCRIPTION	PART #
INPUT BEARING RETAINER (NEW)	18680.11
INPUT GEAR (NEW)	18680.10
RANGE SLEEVE (NEW)	18680.18
PLANETARY GEAR (NEW)	18680.55
PLANETARY GEAR (NEW)	18676.55
OUTPUT SHAFT BEARING (NEW)	18680.48
FRONT YOKE (NEW)	18680.30
CENTER RANGE SHIFT FORK PAD NV249 87-01 XJ, 93-98 ZJ, 99-04 WJ, 02-07 KJ	18680.26

MISC. TRANSFER CASE DRIVE CHAINS

DESCRIPTION	PART #
NEW PROCESS 207, 1980-89 J10	18612.02
NEW PROCESS 207, 1980-83 SJ	18612.02
NEW PROCESS 207, 1984-87 CHEROKEE	18612.02
NEW PROCESS 207, 1987 WRANGLER	18612.02
NEW PROCESS 208, 1980-89 J10	18612.03
NEW PROCESS 208, 1980-83 SJ	18612.03
NEW PROCESS 219, CHEROKEE, WAGONEER	18612.04
NEW PROCESS 228 OR 229, GRAND WAGONEER	18612.04
NEW PROCESS 242, 1980-81 SJ	18612.05
NEW PROCESS 242, 1999-04 GRAND CHEROKEE	18612.05
NEW PROCESS 249, 1980-81 SJ	18612.06
NEW PROCESS 249, 1996-98 GRAND CHEROKEE	18612.06
NEW PROCESS 247, 1996-98 GRAND CHEROKEE	18612.07
NEW PROCESS 247, 1999-04 GRAND CHEROKEE	18612.07
DRIVE CHAIN, 1987-04 WRANGLER AND ALL OTHER 231 MODELS	18612.01



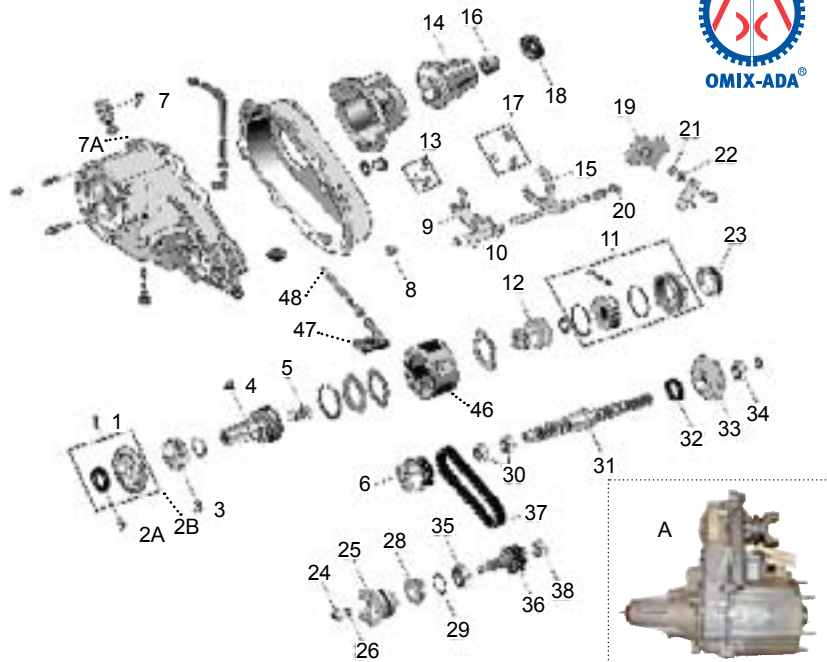

SLIP YOKE ELIMINATOR KIT FOR NP231

This kit is a MUST if you installed a 2" or taller suspension lift (not needed for body lift). The kit fits all newer production NP 231 transfer cases (1987-06). This kit will eliminate the need to drop your transfer case in order to avoid drive train vibrations that are caused by taller suspension lift kits.

The purpose of this kit is to replace the slip yoke portion of the NP 231 with a fixed-yoke, CV style drive shaft assembly. This is the most complete and strongest kit available. Check out the size and thickness of the output shaft housing. NOTE: A CV equipped drive shaft will be required for this conversion kit.

NP231 TRANSFER CASE: 1987-06 WRANGLER, CHEROKEE & GRAND CHEROKEE

DESCRIPTION	PART #	DESCRIPTION	PART #
A NP231 TRANSFER CASE ASSEMBLIES (BRAND NEW), 2.5L 4-CYL W/ MANUAL TRANSMISSION 4.0L 6-CYL W/ MANUAL TRANSMISSION 4.0L 6-CYL W/ AUTOMATIC TRANSMISSION	S-52099310 S-52098358 S-52098360	16 MAIN SHAFT REAR BUSHING, 1987-95 WRANGLER	18676.28
1 INPUT BEARING RETAINER KIT 1987-95 WRANGLER (includes bearing & seal)	18676.01	17 MODE SHIFT FORK PAD (EACH) (NEW)	18680.27
2A INPUT BEARING RETAINER SEAL, 1987-90 WRANGLER	18676.02	17 MODE SHIFT FORK PAD KIT	18676.24
2A INPUT BEARING RETAINER SEAL, 1990-01 WRANGLER	18676.03	18 OUTPUT SHAFT REAR OIL SEAL, 1994-06 WRANGLER	18676.29
2A INPUT BEARING RETAINER SEAL, 2002-05 WRANGLER (NEW)	18680.13	19 SHIFT MODE SELECTOR, 1987-89 WRANGLER	18676.30
2B INPUT BEARING RETAINER (NEW)	18680.11	19 SHIFT MODE SELECTOR, 1991-93 WRANGLER	18676.31
3 INPUT GEAR OUTER BEARING, 1987-95 WRANGLER	18676.04	19 SHIFT MODE SELECTOR, 1997-99 WRANGLER	18676.32
3 INPUT GEAR OUTER BEARING, 1997-99 WRANGLER	18676.05	20 MODE SHIFT FORK BUSHING, 1987-95 WRANGLER	18676.49
4 INPUT GEAR, 21 SPLINE 1997-00 WRANGLER WITH M/T (NEW) 1991-96 WRANGLER 2001-02 WRANGLER 2.5L WITH M/T (NEW) 1991-96 CHEROKEE 1997-98 CHEROKEE 2.5L WITH M/T (NEW) 1999-00 CHEROKEE 2.5L (NEW)	18676.58 18676.08 18676.58 18676.08 18676.58 18676.58	21 SELECTOR SHAFT O-RING	18676.33
4 INPUT GEAR, 23 SPLINE 1987-89 WRANGLER W/ A/T (includes bearing) 1987-90 WRANGLER W/ CASE #S 53008210, 52097893 OR 52098048 1987-90 WRANGLER W/ CASE #S 53006093, 53006096 1997-00 WRANGLER WITH A/T (NEW) 2001-02 WRANGLER 2.5L WITH A/T (NEW) 2001-02 WRANGLER 4.0L (NEW) 1987-90 CHEROKEE W/ CASE #S 53008210, 52097893 OR 52098048 1987-90 CHEROKEE W/ CASE #S 53006093, 53006096 1997-00 CHEROKEE 4.0L (NEW) 1998-02 CHEROKEE 2.5L WITH A/T (NEW) 2001 CHEROKEE (NEW) 1993 GRAND CHEROKEE 1994 GRAND CHEROKEE WITH M/T 1995 GRAND CHEROKEE W/ CASE # 52097526 1994-95 WRANGLER 2.5L (NEW)	18676.06 18676.07 18676.09 18676.59 18676.59 18676.07 18676.09 18676.81 18676.59 18676.81 18676.09 18676.09 18676.10 18676.81	22 SELECTOR SHAFT SEAL	18676.34
5 INPUT GEAR INNER BEARING, 1987-96 WRANGLER (NEW)	18680.12	23 SHIFT MODE SYNCHRONIZER BLOCKING RING, 1987-95 WRANGLER	18676.35
5 INPUT GEAR INNER BEARING, 1997-02 WRANGLER	18676.11	24 FRONT OUTPUT YOKE NUT, 1987-99 WRANGLER	18676.36
5 INPUT BEARING RETAINER NP231, NP242, NV249 YJ 87-95, TJ 97-06, XJ 87-01, ZJ 93-98, KJ 02-07 (NEW)	18680.11	25 FRONT OUTPUT YOKE, CHEROKEE	18676.39
6 DRIVE SPROCKET, 1997-99 WRANGLER	18676.13	25 FRONT OUTPUT YOKE, GRAND CHEROKEE	18676.39
7 VACUUM SWITCH, 1987-93 WRANGLER	18676.14	25 FRONT OUTPUT YOKE, 1987-95 WRANGLER	18676.37
7 ELECTRICAL 4WD SWITCH, 1997-02 WRANGLER	18676.15	25 FRONT OUTPUT YOKE, 1997-99 WRANGLER	18676.38
7A VACUUM SWITCH SEAL, 1987-93 WRANGLER (NEW)	18680.15	26 FRONT OUTPUT YOKE WASHER, 1987-95 WRANGLER	18676.40
9 RANGE SHIFT FORK, 1987-99 WRANGLER EXCEPT 53008210, 11, 12 UNITS 10 RANGE SHIFT FORK BUSHING (2 needed), 1987-93 WRANGLER	18676.17 18676.18	26 FRONT OUTPUT YOKE WASHER, 1997-06 WRANGLER (NEW)	18680.32
11 SHIFT MODE SYNCHRONIZER ASSEMBLY, 1987-93 WRANGLER (w/o blocking ring)	18676.19	27 YOKE STRAP & BOLT KIT, 1987-95 WRANGLER	16582.03
12 RANGE SHIFT HUB 1988-95 WRANGLER	18676.21	28 FRONT OUTPUT SEAL, 1987-96, 2001	18676.41
12 RANGE SHIFT HUB 1997-99 WRANGLER	18676.22	28 FRONT OUTPUT SEAL, 1997-00 (NEW)	18676.56
13 RANGE SHIFT FORK PAD SET, 1987-90 WRANGLER	18676.23	29 FRONT OUTPUT SHAFT BEARING RETAINER	18676.42
13 RANGE SHIFT FORK PAD SET, 1991-99 WRANGLER	18676.24	30 MAIN DRIVE SPROCKET BEARING (2 needed), 1987-89 WRANGLER 1991-95 WRANGLER	18676.43 18676.44
14 CASE REAR EXTENSION, 1987-95 WRANGLER	18676.25	31 MAIN DRIVE, 1987-95 WRANGLER	18676.45
15 MODE SHIFT FORK, 1987-93 WRANGLER W/ CASE #S 53008207, 52097533, 53008209, 52097522, 53008211, 52097524, 53008212, 52097523	18676.26	31 MAIN DRIVE, 1997-99 WRANGLER 2.5L (NEW)	18676.57
15 MODE SHIFT FORK, 1997-99 WRANGLER W/ CASE #S 52097894, 52097893	18676.27	31 MAIN DRIVE, 1987-96 CHEROKEE	18676.45
15 MODE SHIFT FORK, 1997-06 WRANGLER, 1987-01 CHEROKEE, 2002-07 LIBERTY W/ CASE #S 52097696, 52097526, 52097890, 52097888 (NEW)	18676.80	31 MAIN DRIVE, 1997-99 CHEROKEE (NEW)	18676.57
		32 OIL PUMP HOUSING OIL SEAL, 1987-99 WRANGLER	18676.46
		33 OIL PUMP HOUSING & OIL SEAL, 1987-99 WRANGLER	18676.47
		34 REAR OUTPUT SHAFT OUTER BEARING, 1987-99 WRANGLER	18676.48
		35 OUTPUT SHAFT FRONT BEARING, 1987-99 WRANGLER	18676.48
		36 FRONT OUTPUT SHAFT 1987-99 WRANGLER	18676.50
		37 CHAIN, NP231, 1987-04 WRANGLER	18612.01
		37 CHAIN, 1987-01 CHEROKEE	18612.01
		37 CHAIN, 1993-96 GRAND CHEROKEE	18612.01
		38 OUTPUT SHAFT REAR BEARING, 1987-99 WRANGLER	18676.51
		39 REAR OUTPUT SHAFT SLIP YOKE, 1987-93 WRANGLER	16580.53
		40 RTV SILICONE TUBE (use as gasket)	19201.01
		41 1987-06 WRANGLER SLIP YOKE ELIMINATOR KIT: THIS KIT ELIMINATES DRIVELINE VIBRATION PROBLEMS ASSOCIATED W/ LIFTED VEHICLES	18676.60
		41A 1987-06 WRANGLER MEGA SHORT SLIP YOKE ELIMINATOR KIT FOR NP231 (a CV equipped drive shaft will be required for this conversion kit.	18676.72
		42 YOKE, FOR SLIP YOKE ELIMINATOR KIT	18676.61
		43 SPEEDO GEAR, NEW PROCESS 241, DODGE PICK-UP	18677.01
		44 OIL SEAL, USED IN SLIP ELIMINATOR KIT IN NP231	18676.62
		45 SPARE HARDWARE KIT FOR 18676.60 SLIP YOKE ELIMINATOR	18676.64
		46 PLANETARY GEAR, 1987-90 WRANGLER W/ CASE #S 53006092, 53006093, 53006094, 53006095, 53006096, 53006191 (NEW)	18680.55
		46 PLANETARY GEAR, 1991-93 WRANGLER (NEW)	18680.55
		46 PLANETARY GEAR, 1994-01 WRANGLER (NEW)	18676.55
		47 OIL FILTER (NEW)	18680.35
		47 SEAL REAR OUTPUT NP231 WRANGLER (TJ) 97-06, CHEROKEE (XJ) 97-01; NP242 CHEROKEE (XJ) 94-01, GRAND CHEROKEE (ZJ) 94-98, (WJ) 99-04 (NEW)	18676.76
		48 OIL TUBE O-RING (NEW)	18680.36

Transfer Case

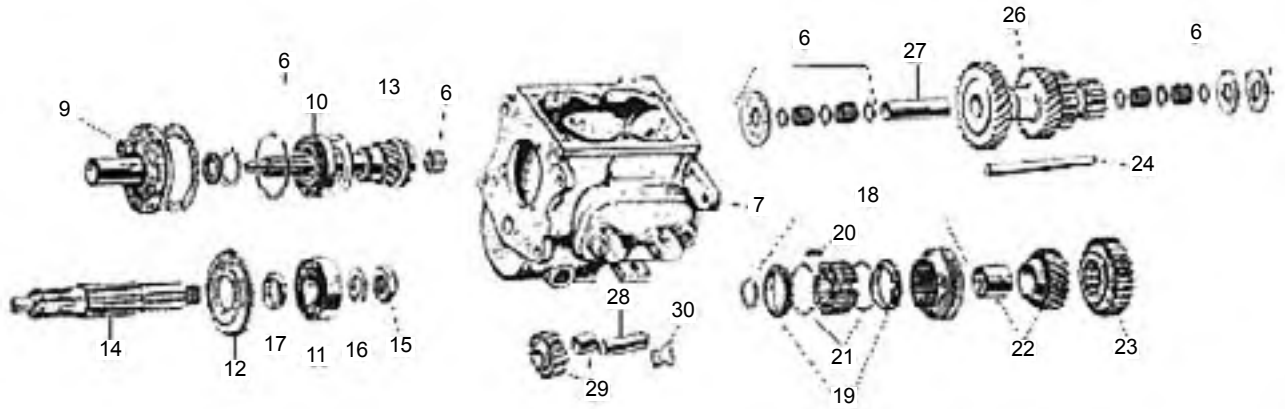

1946-71 WARNER T90 3 SPEED CJ2A, 3A, 3B, 5 & 6, M38, M38A1, 475 WAGON & TRUCK

DESCRIPTION	PART #	DESCRIPTION	PART #
1 OVERHAUL REPAIR KIT KIT INCLUDES FRONT & REAR BEARINGS, GASKET KIT & SMALL PARTS KITS (items 5,6,9,10)	18801.01	14 MAIN SHIFT	18880.10
2 T90 INTERNAL PARTS KIT: KIT INCLUDES: MAIN SHAFT, INPUT SHAFT, 1ST GEAR, 2ND GEAR, 2-3 SYNCHRONIZER ASM, CLUSTER GEAR & SHAFT, REVERSE IDLER GEAR WITH SHAFT, FRONT & REAR BEARINGS, GASKET KIT & SMALL PARTS KIT ALL 4 CYLINDERS & 475 (226) WAGON (9-1/16" input shaft)	18802.01	15 NUT, MAIN SHAFT	18880.11
ALL 475 (226) TRUCK & GM V8 CONVERSION CJ (11.5" input shaft)	18802.02	16 WASHER, MAIN SHAFT	18880.12
3 UNASSEMBLED T90 KIT (all items in #2 plus case): ALL 4 CYLINDERS & 475 (226)WAGON	18802.03	17 SPACER, MAIN SHAFT BEARING	18880.13
GM V8 CONVERSION ENGINE CJ (11.5" INPUT)	18802.04	18 SYNCHRONIZER ASSY, 2ND & 3RD (includes blocking rings)	18880.14
4 COMPLETE ASSEMBLED TRANSMISSION, WITH TOP SHIFTER KIT: ALL 4 CYLINDERS & 475 (226) WAGON (WITH 9 1/16" input shaft)	18803.01	19 BLOCKING RING (each)	18880.15
CJ W/ V8 GM CONVERSION ENG (front retainer not incl)	18803.02	20 KEY, SYNCHRONIZER (3 needed)	18880.16
5 GASKET KIT	18804.01	21 SPRING, SYNCHRONIZER (2 needed)	18880.17
6 SMALL PARTS KIT	18805.01	22 2ND SPEED GEAR WITH BUSHING	18880.18
7 CASE (empty)	18880.01	23 LOW SPEED GEAR	18880.19
8 TRANS. TOP COVER ASSY W/ RAILS & FORKS	18880.02	24 COUNTER SHAFT	18880.20
9 RETAINER, TRANS. FRONT BEARING (all 4 cyls)	18880.03	26 CLUSTER GEAR, COUNTER SHAFT	18880.22
10 BEARING, TRANSMISSION FRONT (for input shaft)	18880.04	33 TEETH (teeth count 33-26-19-14) 4 & 6 CYL	18880.23
11 BEARING, TRANSMISSION REAR (for main shaft)	18880.05	35 TEETH (teeth count 35-26-19-14) MOST OF 1966-71 4 CYL	18880.23
12 ADAPTER, TRANSMISSION REAR BEARING	18880.06	27 SPACER, CLUSTER GEAR	18880.24
13 INPUT SHAFT: ALL 4 CYLINDERS W/ 9-1/16" LENGTH & 18 TEETH	18880.07	28 SHAFT, REVERSE IDLER	18880.25
ALL 4 CYLINDERS W/ 9-1/8" LENGTH & 16 TEETH	18880.08	29 GEAR, REVERSE IDLER WITH BUSHING	18880.26
ALL 6 CYLINDER 475 (226) TRUCKS & V8 GM CONVERSION CJ (11.5")	18880.09	30 PLATE, REVERSE IDLER SHAFT	18880.27
		31 SHIFTER BOOT	18806.01
		31A RETAINER RING FOR TRANSMISSION SHIFTER BOOT COVER	18880.28
		32 SHIFT KNOB	18807.01
		33 TRANSMISSION MOUNT (CJ SERIES)	18608.01
		33 TRANS MOUNT (wagons, trucks, CJ5 V6)	18880.29
		34 REAR MOUNT SUPPORT KIT BOLT & INSULATORS	18608.15

WARNER T14, T84, T98, T15, T18 & SR4

WARNER T14 & T15 3 SPEED 1967-71 225 V6 CJ 1972-75 INLINE 6 CYL 232 CJ

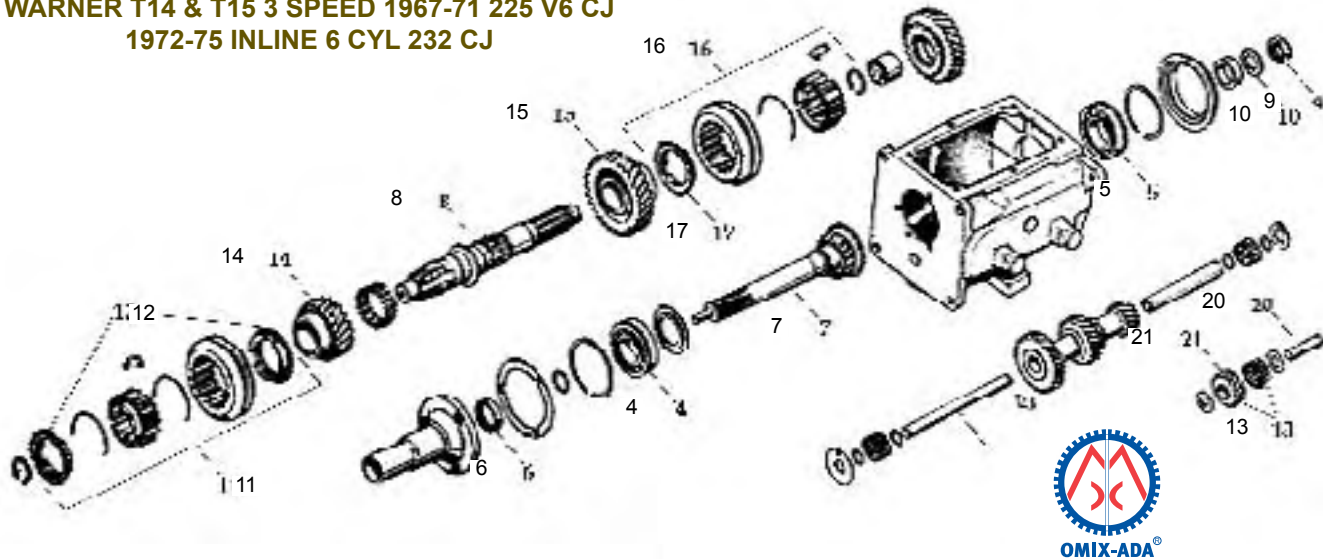

1967-75 WARNER T14 3 SPEED:

DESCRIPTION	PART #
1 OVERHAUL REPAIR KIT: INCLUDES FRONT & REAR BEARINGS, GASKET KIT & SMALL PARTS KIT (items 2, 3, 4, 5)	18801.02
2 GASKET KIT	18804.02
3 SMALL PARTS KIT	18805.02
4 BEARING, TRANSMISSION FRONT (for input shaft)	18881.01
5 BEARING, TRANSMISSION REAR (for input shaft)	18881.02
6 OIL SEAL, MAIN DRIVE RETAINER	18881.03
7 INPUT SHAFT: 11.5" LENGTH, 20 TEETH COUNT, V6 225 ENGINES 10.5" LENGTH, 20 TEETH COUNT, FOR INLINE 6 CYLINDER (232, 258) ENGINES	18881.04
8 MAIN SHAFT	18881.06
9 NUT, MAIN SHAFT	18880.11
10 WASHER, MAIN SHAFT	18880.12
12 BLOCKING RING, 2-3 SYNCHRONIZER (2 needed)	18881.08
14 2ND SPEED GEAR, 26 TEETH	18881.10
17 BLOCKING RING, 1ST & REVERSE	18881.08
18 COUNTER SHAFT	18881.14
19 CLUSTER GEAR, COUNTER SHAFT: 31-25-15-14 TEETH, FOR V6 225 ENGINES	18881.15
22 SHIFTER BOOT	18806.02
23 RETAINER RING FOR BOOT	18881.19
24 SHIFT KNOB	18807.01
25 TRANSMISSION MOUNT, 1967-71	18881.20
25 TRANSMISSION MOUNT, 1972-86 CJ	18608.02
25 URETHANE TRANS. MOUNT, 1972-86 CJ, RED	18392.01
25 URETHANE TRANS. MOUNT, 1972-86 CJ, BLACK	18608.04
26 STABILIZER STUD, TRANSMISSION MOUNT	18608.05
27 STABILIZER BUSHING (2 needed)	18608.06
28 URETHANE STABILIZER BUSHING PAIR, RED	18369.01
28 URETHANE STABILIZER BUSHING PAIR, BLACK	18608.08

1941-45 WARNER T84 3 SPEED:

DESCRIPTION	PART #
SMALL PARTS KIT	18806.12
BLOCKING RING,	18889.01
2nd & 3rd SYNCHRONIZER (2 needed)	
FRONT BEARING	18891.02
REAR BEARING	18880.05
FRONT BEARING RETAINER	18889.03
MB TRANSMISSION SHIFTER BOOT	18889.04
MB TRANSFER CASE SHIFTER BOOT	18889.05
MB 3-PIECE LEATHER BOOT KIT (transmission, transfer case & accelerator cable)	18889.06

1955-72 WARNER T98 4 SPEED:

DESCRIPTION	PART #
SMALL PARTS KIT	18806.13
FRONT BEARING, FOR INPUT SHAFT	18882.01
REAR BEARING, FOR MAIN SHAFT	18884.02
2ND SPEED GEAR	18890.01
COUNTER SHAFT CLUSTER GEAR	18890.02
COUNTER SHAFT	18890.03
3RD & 4TH SYNCHRONIZER ASSY	18890.04
BLOCKING RING, 3rd & 4th SYNCHRONIZER (2 needed)	18890.05
BLOCKING RING, 1st & 2nd SYNCHRONIZER	18890.06

1972-79 WARNER T15 3 SPEED:

DESCRIPTION	PART #
1 T15 OVERHAUL KIT, INCLUDES: 2 BEARINGS, GASKETS & SMALL PARTS KIT	18801.03
2 GASKET & SEAL KIT	18804.03
3 SMALL PARTS KIT	18805.03
4 FRONT BEARING, FOR INPUT SHAFT	18882.01
5 REAR TRANSMISSION BEARING	18882.02
6 OIL SEAL, FRONT RETAINER	18881.03
17 SYNCHRONIZER RING, 1ST, 2ND & 3RD (3 needed)	18882.03
18 COUNTER SHAFT	18882.04
22 SHIFTER BOOT	18806.02
23 BOOT RETAINER RING	18881.19
24 SHIFT KNOB	18807.01
25 TRANSMISSION MOUNT	18608.02
25 POLYURETHANE TRANSMISSION MOUNT, RED	18392.01
25 POLYURETHANE TRANSMISSION MOUNT, BLACK	18608.04
26 STABILIZER STUD, TRANSMISSION MOUNT	18608.05
27 STABILIZER BUSHING (2 NEEDED)	18608.06
28 POLYURETHANE STABILIZER BUSHING PAIR, RED	18369.01
28 POLYURETHANE STABILIZER BUSHING PAIR, BLACK	18608.08

1972-79 WARNER T18 4 SPEED:

DESCRIPTION	PART #
SMALL PARTS KIT	18806.14
FRONT BEARING, FOR INPUT SHAFT	18882.01
REAR BEARING, FOR MAIN SHAFT	18884.02
OIL SEAL, FRONT INPUT SHAFT	18885.03
FIRST GEAR, (synchronizer outer sleeve)	18890.20
FRONT RETAINER	18890.21
3RD GEAR	18890.22
3RD & 4TH SYNCHRONIZER ASSEMBLY: ALL EXCEPT TAG #13-01-192, 13-01-193, 13-01-209, 13-01-210	18890.04
FOR TAG #13-01-192, 13-01-193, 13-01-209, 13-01-210	18890.23
BLOCKING RING, 3RD & 4TH SYNCHRONIZER (2 needed)	
FOR 18890.04	18890.05
FOR 18890.23	18890.25
REVERSE IDLER GEAR	18890.26
COUNTER SHAFT	18890.03
BLOCKING RING, 1ST & 2ND SYNCHRONIZER	18890.06

1980-81 SR4 CJ 4 SPEED:

DESCRIPTION	PART #
BELLHOUSING	16916.02
FRONT BEARING	18891.02
REAR BEARING	18891.02
BLOCKING RING, 1st & 2nd SYNCHRONIZER (2 needed)	18885.14
BLOCKING RING, 3rd & 4th SYNCHRONIZER (2 needed)	18885.23
MAIN DRIVE	18891.03
SHIFTER BOOT	18806.03
OIL SEAL, FRONT RETAINER	18881.03
OIL SEAL, REAR OUTPUT SHAFT	18885.08
TRANSMISSION MOUNT	18608.02
POLYURETHANE TRANSMISSION MOUNT, RED	18392.01
POLYURETHANE TRANSMISSION MOUNT, BLACK	18608.04
STABILIZER STUD, TRANSMISSION MOUNT	18608.05
STABILIZER BUSHING (2 needed)	18608.06
POLYURETHANE STABILIZER BUSHING PAIR, RED	18369.01
POLYURETHANE STABILIZER BUSHING PAIR, BLACK	18608.08

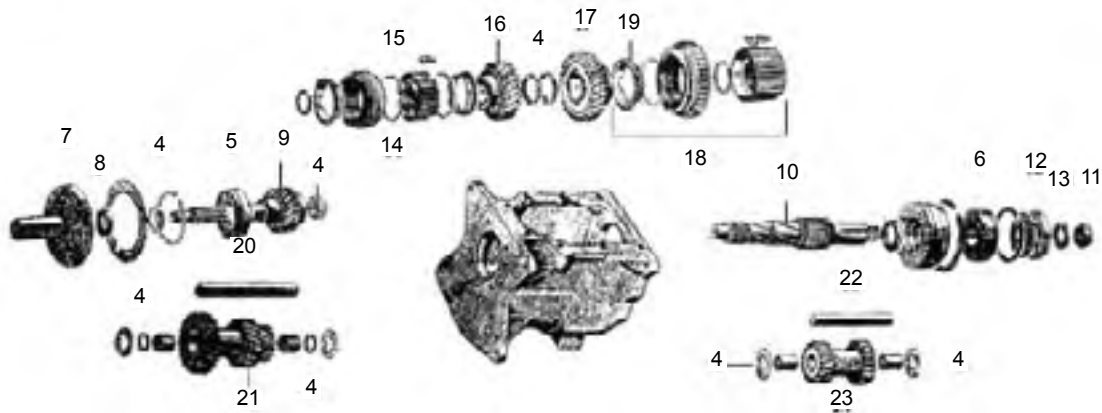

TREMEC T150 3 SPEED 1976-79 6 OR 8 CYL CJ 5 & CJ 7

DESCRIPTION	PART #	DESCRIPTION	PART #
1 OVERHAUL REPAIR KIT INCLUDES FRONT & REAR BEARINGS, GASKETS & SEALS KIT & SMALL PARTS KITS (items 3,4,5,6,8 & 12)	18801.04	15 BLOCKING RING, 2-3 SYNCHRONIZER (2 needed)	18883.06
2 T150 INTERNAL PARTS KIT INCLUDES: MAIN SHAFT, INPUT SHAFT, 1ST GEAR, 2ND GEAR, LOW & REVERSE SYNCHRO ASSY, 2-3 SYNCHRO ASSY, CLUSTER GEAR & SHAFT, REVERSE IDLER GEAR W/ SHAFT, FRONT & REAR BEARINGS, FRONT & REAR OIL SEALS, GASKET KIT, SMALL PARTS KIT	18802.05	16 2ND SPEED GEAR	18883.07
BELLHOUSING	16916.01	17 LOW SPEED GEAR	18883.08
3 GASKET KIT	18804.04	18 SYNCHRONIZER ASSY 1ST & REV (w/ blocking ring)	18883.09
4 SMALL PARTS KITS	18805.04	19 BLOCKING RING, 1ST & REVERSE	18883.10
5 BEARING, TRANSMISSION FRONT (for input shaft)	18880.04	20 COUNTER SHAFT	18883.11
6 BEARING, TRANSMISSION REAR (for main shaft)	18880.05	21 CLUSTER GEAR, COUNTER SHAFT	18883.12
7 RETAINER, INPUT SHAFT	18883.01	22 SHAFT, REVERSE IDLER	18883.13
8 OIL SEAL, MAIN DRIVE RETAINER	18881.03	23 GEAR, REVERSE IDLER W/ BUSHING	18883.14
9 INPUT SHAFT	18883.02	24 BELLHOUSING (1976-79 CJ) 6 OR 8 CYL	16916.01
10 MAIN SHAFT	18883.03	25 SHIFTER BOOT	18806.02
11 NUT, MAIN SHAFT	18880.11	26 RETAINER RING FOR SHIFTER BOOT	18881.19
12 OIL SEAL, REAR MAIN SHAFT	18883.04	27 SHIFT KNOB	18807.01
13 WASHER, MAIN SHAFT	18880.12	28 TRANSMISSION MOUNT	18608.02
14 SYNCHRONIZER ASSY, 2ND & 3RD (w/ blocking rings)	18883.05	28 POLYURETHANE TRANSMISSION MOUNT, RED	18392.01
		28 POLYURETHANE TRANSMISSION MOUNT, BLACK	18608.04
		29 STABILIZER STUD, TRANSMISSION MOUNT	18608.05
		30 STABILIZER BUSHING (2 needed)	18608.06
		30 POLYURETHANE STABILIZER BUSHING PAIR, RED	18369.01
		30 POLYURETHANE STABILIZER BUSHING PAIR, BLACK	18608.08
		31 SHIFT FORK, 1 & REVERSE	18883.15
		32 SHIFT FORK, 2 & 3	18883.16

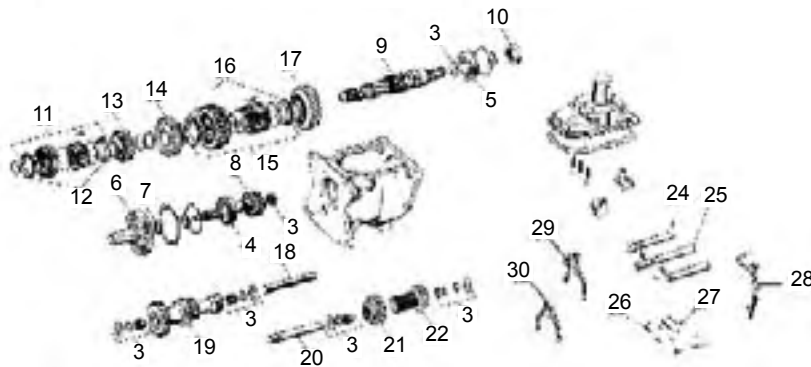

TREMEC T176 & 177 4 SPEED 1980-86 CJ & SJ

DESCRIPTION	PART #	DESCRIPTION	PART #
1 OVERHAUL REPAIR KIT INCLUDES FRONT & REAR BEARINGS, GASKETS & SEALS KIT, SMALL PARTS KIT (items 2,3,4,5)	18801.05	18 COUNTER SHAFT	18884.17
BELLHOUSING	16916.01	19 CLUSTER GEAR, COUNTER SHAFT: 34X27X25X15 TEETH COUNT	18884.18
2 GASKETS & SEALS KIT	18804.05	33X26X24X15 TEETH COUNT	18884.20
3 SMALL PARTS KIT	18805.05	20 SHAFT, REVERSE IDLER	18884.21
4 BEARING, TRANSMISSION FRONT (for input shaft)	18884.01	21 GEAR, REVERSE SLIDING	18884.22
5 BEARING, TRANSMISSION REAR (for main shaft)	18884.02	22 GEAR, REVERSE IDLER	18884.23
6 RETAINER, INPUT SHAFT	18884.03	23 BELLHOUSING 6 & 8 CYL	16916.01
7 OIL SEAL, MAIN DRIVE RETAINER	18881.03	24 SHIFTER RAIL, 1ST & 2ND GEAR	18884.25
8 INPUT SHAFT:		25 SHIFTER RAIL, 3RD & 4TH GEAR	18884.26
T177 WITH 19 TEETH COUNT	18884.05	26 SHIF RAIL PLATE, FRONT	18884.27
9 MAIN SHAFT	18884.06	27 SHIF RAIL PLATE, REAR	18884.28
10 OIL SEAL, REAR MAIN SHAFT	18676.02	28 SHIF FORK, REVERSE GEAR	18884.29
11 SYNCHRONIZER ASSY, 3RD & 4TH (w/ blocking rings)	18884.08	29 SHIF FORK, 1-2 GEAR	18884.30
12 BLOCKING RING, 3-4 SYNCHRONIZER (2 needed)	18883.10	30 SHIF FORK, 3-4 GEAR	18884.31
13 3RD SPEED GEAR:		31 SHIFTER REPAIR KIT	18884.32
T176 WITH 23 TEETH COUNT	18884.10	32 SHIFTER BOOT (double nipple)	18606.05
T177 WITH 22 TEETH COUNT	18884.11	33 SHIF KNOB (w/o shift pattern plate)	18607.03
14 2ND SPEED GEAR:		34 SHIF PATTERN PLATE (for 18607.03)	18884.33
T177 WITH 32 TEETH COUNT	18884.13	35 SHIF KNOB LOWER NUT	18607.05
15 SYNCHRONIZER ASSY 1ST & 2ND (w/ blocking ring)	18884.14	36 TRANSMISSION MOUNT	18608.02
16 BLOCKING RING, 1ST & 2ND (2 needed)	18883.10	36 POLYURETHANE TRANSMISSION MOUNT, RED	18392.01
16A BLOCKING RING KIT 4 PCS. (2 x 1-2 & 2 x 3-4)	18884.15	36 POLYURETHANE TRANSMISSION MOUNT, BLACK	18608.04
17 1ST SPEED GEAR	18884.16	37 STABILIZER STUD, TRANSMISSION MOUNT	18608.05
		38 STABILIZER BUSHING (2 needed)	18608.06
		38 POLYURETHANE STABILIZER BUSHING PAIR, RED	18369.01
		38 POLYURETHANE STABILIZER BUSHING PAIR, BLACK	18608.08
		39 SHIFTER LEVER	18884.37



WARNER T4 4 SPEED 1982-86 CJ

DESCRIPTION	PART #	DESCRIPTION	PART #
3 TUBE OF SILICONE (to be used as gasket)	19201.01	18 CLUSTER GEAR KIT (includes 27 teeth, 3rd gear)	18885.16
4 SMALL PARTS KITS	18805.07	20 REAR CLUSTER GEAR BEARING	16536.22
5 BEARING & CUP, TRANS FRONT (for input shaft)	16536.15	26 GEAR, REVERSE IDLER W/ BUSHING	18885.26
6 BEARING & CUP, TRANS REAR (for main shaft)	18885.01	27 BELLHOUSING (1982-86 CJ) 6 OR 8 CYL	16916.02
7 RETAINER, FRONT INPUT SHAFT	18885.02	28 SHIFTER BOOT	18806.03
8 OIL SEAL, MAIN DRIVE RETAINER	18885.03	29 SHIFT KNOB (without shift pattern plate)	18607.03
9 INPUT SHAFT (4th gear):		30 SHIFT PATTERN PLATE (for above shift knob)	18884.33
21 TEETH WITH 10 SPLINE CLUTCH DISC	18885.04	31 SHIFT KNOB LOCK NUT	18607.05
10 MAIN SHAFT (with 1st & 2nd gear synchronizer)		32 TRANSMISSION MOUNT	18608.02
FOR USE WITH MODELS WITHOUT 1ST GEAR		32 POLYURETHANE TRANSMISSION MOUNT, RED	18608.03
NEEDLE BEARING	18885.06	32 POLYURETHANE TRANSMISSION MOUNT, BLACK	18608.04
FOR USE WITH MODELS WITH 1ST GEAR		33 STABILIZER STUD, TRANSMISSION MOUNTING	18608.05
11 OIL SEAL, REAR OUTPUT SHAFT	18885.08	34 STABILIZER BUSHING (2 needed)	18608.06
12 SYNCHRONIZER ASSY, 3rd & 4th	18885.09	34 POLYURETHANE STABILIZER BUSHING PAIR, RED	18608.07
13 BLOCKING RING, 3-4 SYNCHRONIZER (2 needed)	18885.10	34 POLYURETHANE STABILIZER BUSHING PAIR, BLACK	18608.08
14 3RD SPEED GEAR: 27 TOOTH COUNT	18885.11	35 TRANSMISSION MOUNTED SHIFT BOOT	18885.30
16 BLOCKING RING, 1st & 2nd SYNCHRONIZER (2 needed)	18885.14	36 SHIFTER LEVER KIT WITH CLIP & INSULATOR, FOR 1982-86 CJ W/ T4 OR T5 TRANSMISSION	18885.31
		SHIFTER HANDLE CLIP, FOR 1982-86 CJ W/ T4 OR T5 TRANSMISSION	18885.32
		SHIFTER HANDLE INSULATOR, FOR T4 OR T5 TRANSMISSION	18885.33
		SHIFTER LEVER, FOR 1982-86 CJ W/ T4 OR T5 TRANSMISSION	18885.34

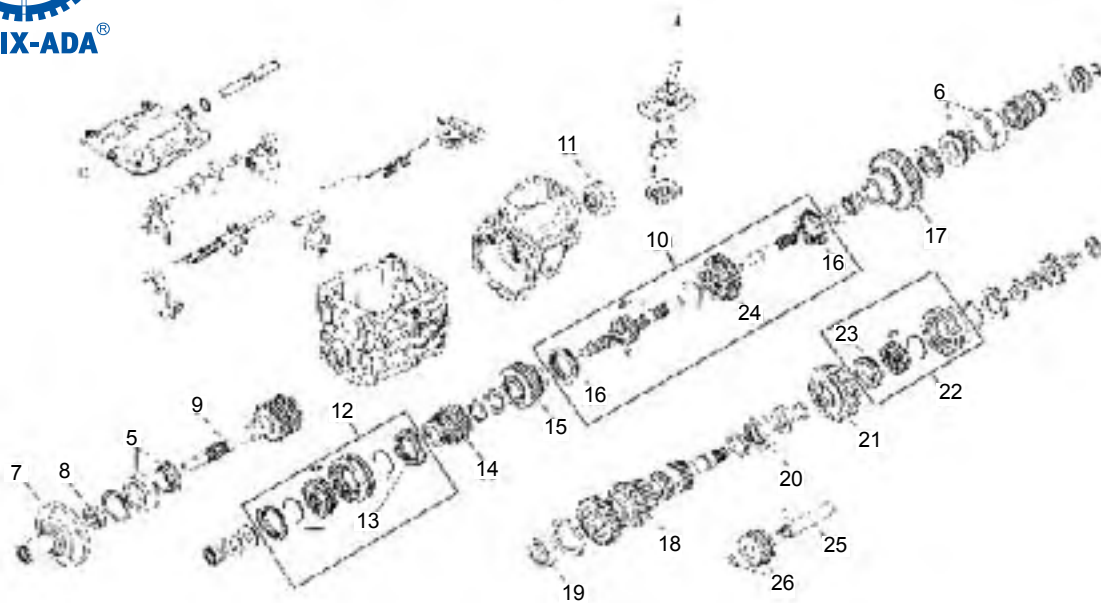

WARNER T5 5 SPEED 1982-86 CJ

DESCRIPTION	PART #	DESCRIPTION	PART #
2 OVERHAUL REPAIR KIT INCLUDES FRONT & REAR BEARINGS, GASKETS & SEALS KIT, SMALL PARTS KITS (items 3, 4, 5, 6, 8, 11, 19 & 20)	18806.07	23 BLOCKING RING FOR 5th SYNCHRONIZER	18885.23
3 TUBE OF SILICONE (to be used as gasket)	19201.01	26 GEAR, REVERSE IDLER WITH BUSHING	18885.26
4 SMALL PARTS KIT	18805.07	27 BELLHOUSING (1980-86 CJ), 6 CYL OR 8 CYL	16916.02
5 BEARING & CUP, TRANS FRONT (for input shaft)	16536.15	28 SHIFTER BOOT	18806.03
6 BEARING & CUP, TRANS REAR (for main shaft)	18885.01	29 SHIFT KNOB (without shift pattern plate)	18607.03
7 RETAINER, FRONT INPUT SHAFT	18885.02	30 SHIFT PATTERN (for above shift knob)	18885.28
8 OIL SEAL, MAIN DRIVE RETAINER	18885.03	31 SHIFT KNOB LOCK NUT	18607.05
9 INPUT SHAFT (4th gear)		32 TRANSMISSION MOUNT	18608.02
21 TOOTH WITH 10 SPLINE CLUTCH DISC	18885.04	32 POLYURETHANE TRANSMISSION MOUNT, RED	18608.03
10 MAIN SHAFT (includes 1st & 2nd gear synchronizer)		32 POLYURETHANE TRANSMISSION MOUNT, BLACK	18608.04
USE ON MODEL W/O 1st GEAR NEEDLE BEARING	18885.06	33 STABILIZER STUD, TRANSMISSION MOUNT	18608.05
11 OIL SEAL, REAR OUTPUT SHAFT	18885.08	34 STABILIZER BUSHING (2 needed)	18608.06
12 SYNCHRONIZER ASSEMBLY, 3rd & 4th	18885.09	34 POLYURETHANE STABILIZER BUSHING PAIR, RED	18608.07
13 BLOCKING RING, 3-4 SYNCHRONIZER (2 needed)	18885.10	34 POLYURETHANE STABILIZER BUSHING PAIR, BLACK	18608.08
14 3rd SPEED GEAR: 27 TOOTH COUNT	18885.11	35 1982-86 CJ TRANS. MOUNTED SHIFTER BOOT	18885.30
16 BLOCKING RING, 1st & 2nd (2 needed)	18885.14	36 SHIFTER LEVER KIT WITH CLIP & INSULATOR, FOR 1982-86 CJ WITH T4 OR T5 TRANSMISSION	18885.31
18 CLUSTER GEAR KIT (includes 27 tooth 3rd gear)	18885.17	SHIFTER HANDLE CLIP, FOR 1982-86 CJ WITH T4 OR T5 TRANSMISSION	18885.32
19 FRONT CLUSTER GEAR BEARING	18885.19	SHIFTER HANDLE INSULATOR, FOR T4 OR T5 TRANSMISSION	18885.33
20 REAR CLUSTER GEAR BEARING	16536.22	SHIFTER LEVER, 1982-86 CJ W/ T4 OR T5 TRANS.	18885.34

PEUGEOT BA 10/5 & AUTOMATIC TRANS. PARTS

PEUGEOT BA 10/5 5 SPEED 1987-89 WRANGLER & CHEROKEE

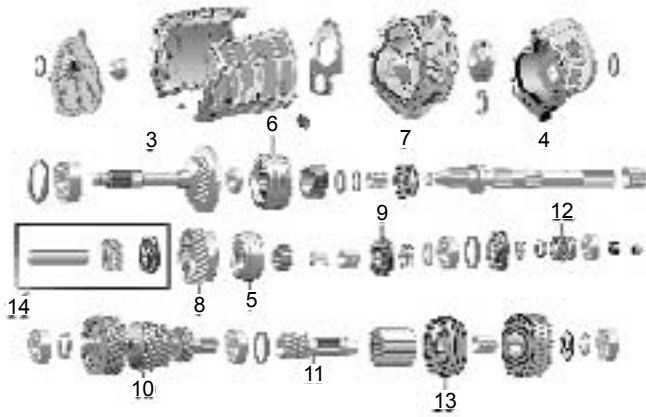

DESCRIPTION	PART #
1 BEARING & OIL SEAL KIT (includes all 7 bearings & 3 oil seals)	18801.11
2 TUBE OF SILICONE (to be used as gasket)	19201.01
3 INPUT SHAFT	18888.01
3 INPUT SHAFT	18888.02
4 MAIN SHAFT	18888.03
5 SYNCHRONIZER ASSY, 1st & 2nd	18888.04
6 SYNCHRONIZER ASSY, 3rd & 4th	18888.05
7 3rd SPEED GEAR	18888.06
8 2nd SPEED GEAR	18888.07
9 1st GEAR 12-32 TOOTH COUNT	18888.08
9 1st GEAR	18888.09
10 CLUSTER GEAR	18888.10
10 CLUSTER GEAR	18888.11
11 5th GEAR, INTERMEDIATE	18888.12
13 5th GEAR SYNCHRONIZER	18888.14
14 REVERSE GEAR KIT (as shown in block)	18888.15
15 TRANSMISSION MOUNT (Wrangler only)	18608.09
16 STABILIZER STUD, TRANSMISSION MOUNT	18608.05
17 STABILIZER BUSHING (2 needed)	18608.06
17 POLYURETHANE STABILIZER BUSHING PAIR, RED	18608.07
17 POLYURETHANE STABILIZER BUSHING PAIR, BLACK	18608.08



AUTOMATIC TRANSMISSION REBUILD KITS:

THESE SUPER KITS INCLUDE: Overhaul gasket & seal kit, all friction plates, all steel clutch plates, Flex Band (if required), filter & bushings and all friction and steel clutch plates

DESCRIPTION	PART #
1987-03 4 OR 6 CYL, WRANGLERS, TF6	19001.04
1987-01 4 OR 6 CYL, CHEROKEE, AW4 TYPE	19001.03
1993-98 6 CYL GRAND CHEROKEE, A-500 TYPE	19001.01
1999-04 6 CYL GRAND CHEROKEE, A-500 TYPE	19001.01
1993-98 V8, GRAND CHEROKEE, A-518 TYPE	19001.02
1987-93 MJ COMMANCHE, AW4 TYPE	19001.03

NOTE: # 19001.05 - IS NOT A SUPER KIT- IT CONTAINS: overhaul gasket & seal kit, all friction & steel clutch plates

DESCRIPTION	PART #
1999-04 4.7L V8 GRAND CHEROKEE,	19001.05
2002-04 4 OR 6 CYL LIBERTY, 45RFE TYPE	19001.05

AUTOMATIC TRANSMISSION MOUNTS:

DESCRIPTION	PART #
1984-90 4 CYL CHEROKEE	19005.01
1985-86 2.1L DIESEL CHEROKEE, MANUAL TRANS	19005.03
1984-2000 2.5L CHEROKEE, MANUAL TRANS, 2WD OR 4WD	19005.03
1987-99 4.0L CHEROKEE	19005.01
2000-01 4.0L CHEROKEE	19005.04
1994-95 4.0L GRAND CHEROKEE	19005.05
1996 4.0L GRAND CHEROKEE	19005.06
1997-98 4.0L GRAND CHEROKEE	19005.07
1994-98 5.2L & 5.9L GRAND CHEROKEE	19005.08
1999 4.0L GRAND CHEROKEE, 4WD	19005.09
1999 4.0L GRAND CHEROKEE, 2 WD	19005.10
2000-04 GRAND CHEROKEE, 2WD	19005.11
2000 4.0L GRAND CHEROKEE, 4WD	19005.12
2001-04 4.0L GRAND CHEROKEE, 4WD	19005.13
1999-04 4.7L V8 GRAND CHEROKEE, 4WD	19005.14

AUTOMATIC TRANSMISSION FILTERS:

DESCRIPTION	PART #
1987-02 WRANGLER	19003.04
1987-02 WRANGLER WITH GASKET	19003.05
1994-01 4 CYL CHEROKEE	19003.04
1994-01 4 CYL CHEROKEE WITH GASKET	19003.05
1987-01 4.0L CHEROKEE	19003.06
1987-93 2.5L CHEROKEE	19003.06
1987-01 4.0L CHEROKEE WITH GASKET	19003.07
1987-93 2.5L CHEROKEE WITH GASKET	19003.07
1999-04 6 CYL GRAND CHEROKEE FOR 42RE	19003.01
1999-06 2WD V8 GRAND CHEROKEE, 3 PIECES KIT	19003.02
1999-06 4WD V8 GRAND CHEROKEE, 3 PCS KIT, FOR 45RFE	19003.03
1993-98 V8 GRAND CHEROKEE	19003.04
1993-98 V8 GRAND CHEROKEE WITH GASKET	19003.05
1993 4.0L GRAND CHEROKEE	19003.06
1993 4.0L GRAND CHEROKEE WITH GASKET	19003.07
2002-06 2WD V6 LIBERTY, 3 PIECES KIT	19003.02
2002-03 2WD V6 LIBERTY, 3 PIECES KIT	19003.02
2002-06 4WD V6 LIBERTY, 3 PIECES KIT, FOR 45RFE	19003.03
2002-03 4WD V6 LIBERTY, 3 PIECES KIT, FOR 45RFE	19003.03



AINIS AX4 & AX5

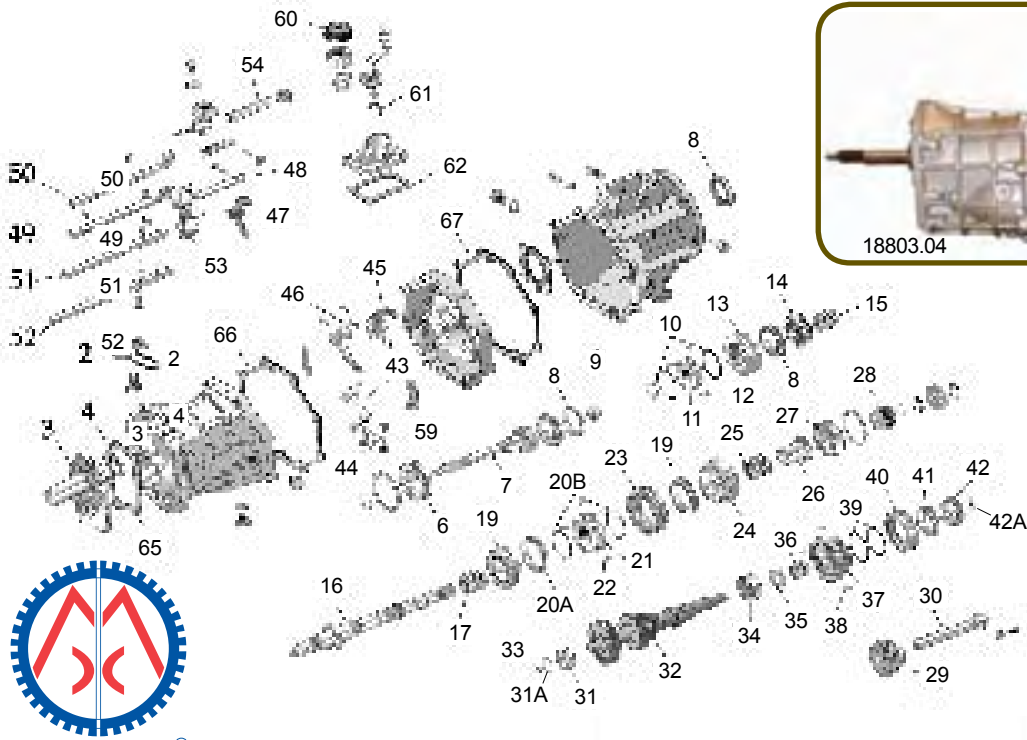

AINIS AX4 & AX5 1987-02 4 CYL WRANGLER & 1984-00 CHEROKEE

DESCRIPTION	PART #	DESCRIPTION	PART #
AX5 TRANSMISSION ASSEMBLY, 1984-96 CHEROKEE (1984-93 may require some modification) (NEW)	18803.04	29 REVERSE IDLER GEAR 1987-98 WRANGLER	18886.44
AX5 TRANSMISSION ASSEMBLY, 1987-95 WRANGLER (may require some modification) (NEW)	18803.04	29 REVERSE IDLER GEAR 1984-97 CHEROKEE	18886.44
AX5 TRANSMISSION ASSEMBLY, 97-02 TJ 2.5L WRANGLER (NEW)	18803.05	29 REVERSE IDLER GEAR 1998-02	18886.45
1 OVERHAUL KIT (bearings & seals kit) 1984-87 AX5 ONLY	18806.08	30 REVERSE IDLER SHAFT 1984-99	18886.46
1 OVERHAUL KIT (bearings & seals kit) 1987-99 AX5 ONLY	18806.09	31 CLUSTER GEAR FRONT BEARING 1984-02	18886.47
2 BACKUP LAMP SWITCH, 1987-02	18886.01	31A SNAP RING, 2.25mm, (NEW)	18892.28
3 FRONT BEARING RETAINER 1984-96 (except diesels)	18886.02	32 CLUSTER GEAR (nut type) 1984-90	18886.48
3 FRONT BEARING RETAINER 1997-02 4WD	18886.03	32 CLUSTER GEAR 1989-99 WRANGLER	18886.49
4 FRONT BEARING RETAINER SEAL 1984-02	18886.04	32 CLUSTER GEAR 1989-97 CHEROKEE	18886.49
5 REAR ADAPTER OUTPUT SEAL 1984-02	18886.05	32 CLUSTER GEAR 1998-00 CHEROKEE	18886.50
6 FRONT INPUT SHAFT BEARING 1984-85 CHEROKEE	18886.06	32 CLUSTER GEAR NUT 1984 TO 11/5/88	18886.51
6 FRONT INPUT SHAFT BEARING 1986-02	18886.07	33 CLUSTER GEAR BEARING SNAP RING	18886.52
7 INPUT SHAFT 1984-85 CHEROKEE	18886.08	34 CLUSTER GEAR REAR BEARING 1984 TO 11/5/88	18886.53
7 INPUT SHAFT 1986 TO 11/5/88 2.5L (except diesels)	18886.09	34 CLUSTER GEAR REAR BEARING 11/5/88 TO 2002	18886.54
7 INPUT SHAFT 11/5/88 TO 2002	18886.10	35 CLUSTER GEAR THRUST WASHER	18886.55
8 3rd & 4th SYNCHRONIZER RING (2 needed) 1984-02	18886.11	36 5th GEAR NEEDLE BEARING 1987-02	18886.56
9 INPUT SHAFT NEEDLE BEARING (14 needed) 1984-02	18886.12	37 5th GEAR (cluster gear side) 1987-02	18886.57
10 3rd & 4th SYNCHRONIZER SPRING (2 needed) 1984-02	18886.13	38 5th GEAR SYNCH. KEY PLATE (2 needed) 1987-99	18886.58
11 3rd & 4th SYNCHRONIZER HUB 1984 TO 11/5/88	18886.14	39 5th GEAR SYNCH. SPRING (2 needed) 1984-02	18886.13
11 3rd & 4th SYNCHRONIZER HUB 11/5/88 TO 2002	18886.15	40 5th GEAR SYNCHRONIZER SLEEVE 1988-93	18886.60
12 3rd & 4th SYNCHRONIZER KEY PLATE 1984 TO 11/5/88	18886.16	40 5th GEAR SYNCHRONIZER SLEEVE 1994-02	18886.61
12 3rd & 4th SYNCHRONIZER KEY PLATE 11/5/88 TO 1999	18886.17	41 5th GEAR SYNCHRONIZER RING 1984-02	18886.11
13 3rd & 4th SYNCHRONIZER SLEEVE 1984 TO 11/5/88	18886.18	42 5th GEAR SPACER GEAR 1988-02	18886.63
13 3rd & 4th SYNCHRONIZER SLEEVE 1997-02	18886.20	42A 5th GEAR SNAP RING, 2.73mm, (NEW)	18892.08
14 3rd SPEED GEAR 11/5/88 TO 2002	18886.22	42A 5th GEAR SNAP RING, 3.03mm, (NEW)	18892.13
15 3rd SPEED GEAR NEEDLE BEARING 1984-02	18886.23	43 REVERSE SHIFT FORK 1984-02	18886.64
16 MAIN SHAFT 4WD 1984-02	18886.24	45 1st & 2nd SHIFT FORK 1986-89	1888
17 MAIN SHAFT 1ST GEAR PIN	18886.25	45 1st & 2nd SHIFT FORK 1990-99	18886.67
18 2nd SPEED GEAR NEEDLE BEARING 1987-02 WRANGLER	18886.26	46 3rd & 4th GEAR SHIFT FORK 1984-02	18886.68
18 2nd SPEED GEAR NEEDLE BEARING 1984-96 CHEROKEE	18886.26	47 5th GEAR SHIFT FORK 1987 TO 4/1/93	18886.69
19 2nd SPEED GEAR 1984 TO 11/5/88	18886.27	47 5th GEAR SHIFT FORK 1993-02	18886.70
19 2nd SPEED GEAR 11/5/88 TO 2002	18886.28	48 REAR REVERSE GEAR SHIFT SHAFT 1984-02	18886.71
20A 1st & 2nd SYNCHRONIZER RING 1984-02	18886.29	49 1st & 2nd GEAR SHIFT SHAFT 1984-02	18886.72
20B 1st & 2nd SYNCHRONIZER SPRING (2 needed) 1984-02	18886.30	50 3rd & 4th GEAR SHIFT SHAFT 1987-02 AX5	18886.73
21 1st & 2nd SYNCHRONIZER HUB 1984-02	18886.31	51 FRONT REVERSE GEAR SHIFT SHAFT 1984-88 AX4	18886.74
22 1st & 2nd SYNCHRONIZER KEY PLATE 1984-02	18886.32	51 FRONT REVERSE GEAR SHIFT SHAFT 1988-99 AX5	18886.75
23 REVERSE GEAR 1987-98 WRANGLER	18886.33	52 5TH GEAR SHIFT SHAFT 1987-02 AX5	18886.76
23 REVERSE GEAR 1984-97 CHEROKEE	18886.33	53 REVERSE SHIFT HEAD 1984-96	18886.77
23 REVERSE GEAR 1998-02 WRANGLER	18886.34	53 REVERSE SHIFT HEAD 1997-02	18886.78
23 REVERSE GEAR 1998-00 CHEROKEE	18886.34	54 SHIFT LEVER SHAFT	18886.79
24 1st SPEED GEAR 1984 TO 11/5/88	18886.35	55 REVERSE RIGHT HAND SHIFT PIN	18886.80
24 1st SPEED GEAR 11/5/88 TO 2002	18886.36	56 REVERSE LEFT HAND SHIFT PIN	18886.81
25 1st GEAR NEEDLE BEARING 1984 TO 11/5/88	18886.37	57 REVERSE BALL	18886.82
25 1st GEAR NEEDLE BEARING 11/5/88 TO 2002	18886.38	58 OIL FILLER PIPE	18886.83
26 1st GEAR RACE 1984 TO 11/5/88	18886.39	59 SHIFT ARM SHOE	18886.84
26 1st GEAR RACE 11/5/88 TO 2002	18886.40	60 GEAR SHIFT BOOT, TRANS MOUNTED 1987-99	18886.85
27 MAIN SHAFT REAR BEARING 1984 TO 11/5/88	18886.41	61 SHIFT CUP BUSHING 1987-99	18886.86
27 MAIN SHAFT REAR BEARING 11/5/88 TO 2002	18886.42	62 SHIFT COVER GASKET 1987-99	18886.87
28 5th GEAR (main shaft side) 11/5/88 TO 2002	18886.43	64 TRANSMISSION MOUNT 1987-95 WRANGLER	18608.09
		64 TRANSMISSION MOUNT 1997-06 WRANGLER	18608.10
		64 TRANSMISSION MOUNT 1997-06 WRANGLER POLYURETHANE, RED	18608.11
		64 TRANSMISSION MOUNT 1997-06 WRANGLER POLYURETHANE, BLACK	18608.12
		64 TRANSMISSION MOUNT 1987-96 CHEROKEE	19005.03
		GASKET KIT, AX5 & AX15	18804.06
		65 GASKET TRANSMISSION SHIFT	18886.89
		66 GASKET	18886.90
		67 GASKET	18886.91

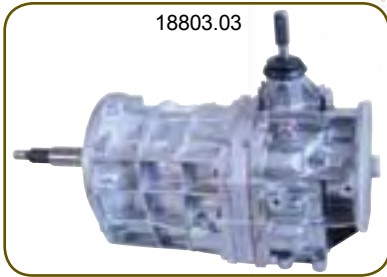
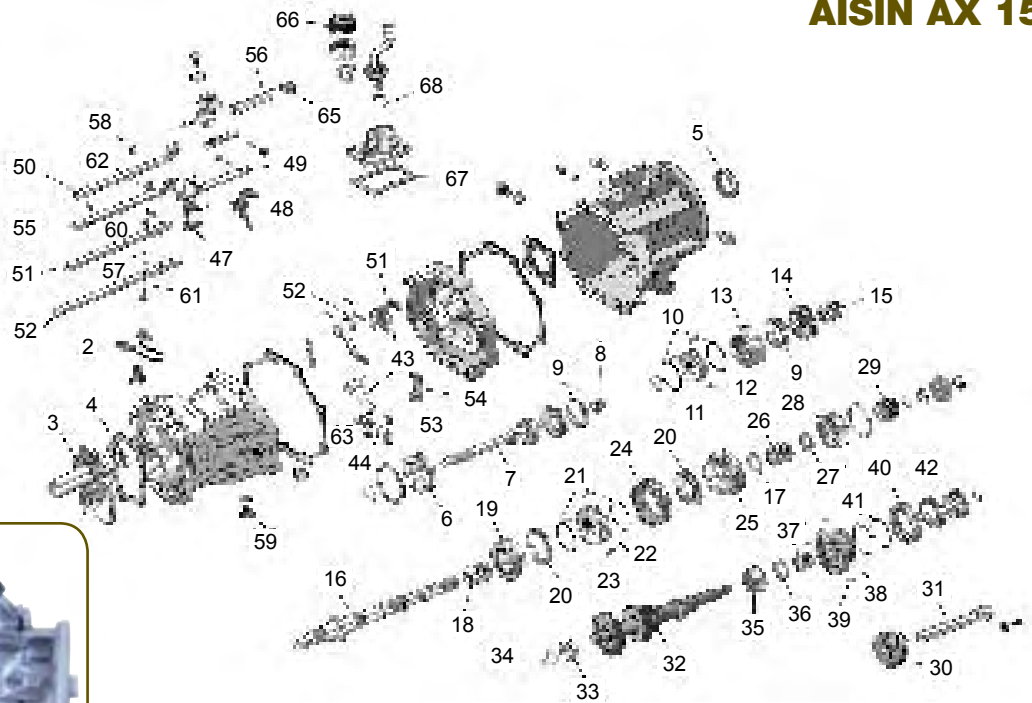

AINIS AX15 1987-99 6 CYL WRANGLER & 1984-01 6 CYL CHEROKEE

DESCRIPTION	PART #	DESCRIPTION	PART #
AX15 TRANS ASSEMBLY, 1994-99 WRANGLER (NEW)	18803.03	35 CLUSTER GEAR REAR BEARING 1989-99	18887.43
AX15 TRANS ASSEMBLY, 1994-99 CHEROKEE (NEW)	18803.03	36 CLUSTER GEAR REAR THRUST WASHER	18887.44
1 OVERHAUL BEARING & SEAL KIT 1989-99	18806.10	37 5th GEAR NEEDLE BEARING 1989-99	18887.45
2 BACKUP LAMP SWITCH	18886.01	38 5th GEAR (cluster gear side) 1987-92 =5252080 (before s/n 00705124)	18887.48
3 FRONT BEARING RETAINER, 1987-91	18887.01	38 5th GEAR (cluster gear side) 1992-99 (from s/n 00705124)	18887.49
3 FRONT BEARING RETAINER, 1992-93	18887.02	39 5th GEAR SYNCHRONIZER KEY PLATE (3 needed) 1987-92 (before s/n 00705124)	18887.51
3 FRONT BEARING RETAINER, 1994-99	18887.03	39 5th GEAR SYNCHRONIZER KEY PLATE (3 needed) 1992-99 (from s/n 00705124)	18887.52
4 FRONT BEARING RETAINER OIL SEAL 1989-99	18887.04	39A 5th GEAR (cluster side) SPACER	18887.50
5 REAR ADAPTER OIL SEAL (4WD models only) 1987-99	18886.05	40 5th GEAR SYNCHRONIZER SLEEVE 1987-99	18887.53
6 INPUT SHAFT (front) BEARING 1989-99	18887.06	41 5th GEAR SYNCHRONIZER SPRING (2 needed) 1987-92 (before s/n 00705124)	18887.27
7 INPUT SHAFT 1989-91	18887.07	41 5th GEAR SYNCHRONIZER SPRING (2 needed) 1992-99 (from s/n 00705124)	18887.55
7 INPUT SHAFT 1992-97	18887.08	42 5th GEAR SYNCHRONIZER RING 1987-92 (before s/n 00705124)	18887.11
7 INPUT SHAFT 1998-99	18887.09	42 5th GEAR SYNCHRONIZER RING 1992-99 (from s/n 00705124)	18887.57
8 INPUT SHAFT ROLLER BEARING	18887.10	43 REVERSE SHIFT FORK	18887.58
9 3rd-4th GEAR SYNCHRONIZER RING (2 needed) 1989-99 WRANGLER	18887.11	44 REVERSE SHIFT ARM	18887.59
9 3rd-4th GEAR SYNCHRONIZER RING (2 needed) 1989-97 CHEROKEE	18887.11	45 FRONT REVERSE GEAR SHIFT SHAFT	18887.60
9 3rd-4th GEAR SYNCHRONIZER RING (2 needed) 1998-99 CHEROKEE	18887.12	46 5th GEAR SHIFT SHAFT	18887.61
10 3rd-4th GEAR SYNCHRONIZER SPRING (2 needed) 1989-99	18887.13	47 REVERSE SHIFT HEAD	18887.62
11 3rd-4th GEAR SYNCHRONIZER HUB 1989-99	18887.14	48 5th GEAR SHIFT FORK	18887.63
12 3rd-4th GEAR SYNCHRONIZER KEY PLATE (3 needed) 1989-99	18887.15	49 REAR REVERSE GEAR SHIFT SHAFT	18887.64
13 3rd-4th GEAR SYNCHRONIZER SLEEVE 1989-97	18887.16	50 3RD & 4TH GEAR SHIFT SHAFT	18887.65
13 3rd-4th GEAR SYNCHRONIZER SLEEVE 1998-99	18887.17	51 1ST & 2ND SHIFTING FORK	18887.66
14 3rd SPEED GEAR 1989-97	18887.18	52 3RD & 4TH SHIFTING FORK	18887.67
14 3rd SPEED GEAR 1998-99	18887.19	53 SHIFT ARM SHOE	18887.68
15 3rd SPEED GEAR NEEDLE BEARING 1989-99	18887.20	54 BRACKET SHIFTING	18887.69
16 MAIN SHAFT, 4WD MODELS ONLY (16-1/8" long) 1987-99	18887.21	55 GEAR SHIFTING SHAFT	18887.70
17 MAIN SHAFT FIRST GEAR SPACER 1989-99	18887.22	56 SHAFT SHIFT LEVER	18887.71
18 2nd SPEED GEAR NEEDLE BEARING 1989-99	18886.23	57 PIN, REVERSE RIGHT HAND	18887.72
19 2nd SPEED GEAR 1989-91	18887.24	58 RETAINER CLIP 1.5mm	18887.73
19 2nd SPEED GEAR 1992-99	18887.25	59 DRAIN PLUG	18887.74
20 1st-2nd SPEED GEAR SYNCHRONIZER RING (2 needed) 1987-99	18887.26	60 ROLLER	18887.75
21 1st-2nd SPEED GEAR SYNCHRONIZER SPRING (2 needed) 1987-99	18887.27	61 BALL	18887.76
22 1st-2nd SPEED GEAR SYNCHRONIZER HUB 1987-99	18887.28	62 ROLLER	18887.77
23 1st-2nd SPEED GEAR SYNCHRONIZER PLATE (3 needed) 1987-99	18887.29	63 RING RETAINER	18887.78
24 REVERSE GEAR 1987-99	18887.30	64 BALL, REVERSE	18887.82
25 FIRST SPEED GEAR, 1989-92	18887.31	65 HOUSING PLUG	18887.80
25 FIRST SPEED GEAR, 1993-99	18887.32	65 HOUSING PLUG	18887.81
26 FIRST GEAR NEEDLE BEARING 1987-99	18887.33	66 GASKET, TRANSMISSION SHIFTER	18887.89
27 FIRST GEAR THRUST WASHER 1987-99	18887.34	67 SHIFT COVER GASKET	18887.87
28 MAIN SHAFT REAR BEARING 1989-98	18887.35	68 SHIFT CUP BUSHING	18887.86
29 5th GEAR (main shaft side) 1989-99	18887.36	71 TRANSMISSION MOUNT 1987-95 WRANGLER	18608.09
30 REVERSE IDLER GEAR 1989-99	18887.37	71 TRANSMISSION MOUNT 1997-06 WRANGLER	18608.10
31 REVERSE IDLER SHAFT 1989-99	18887.38	71 TRANSMISSION MOUNT, 1997-06 WRANGLER POLYURETHANE, RED	18608.11
32 CLUSTER GEAR 1987-91	18887.39	71 TRANSMISSION MOUNT, 1997-06 WRANGLER POLYURETHANE, BLACK	18608.12
32 CLUSTER GEAR 1992-99	18887.40	GASKET KIT, AX5 & AX15	18804.06
33 CLUSTER GEAR FRONT BEARING 1989-99	18887.41		
34 CLUSTER GEAR FRONT BEARING SNAP RING	18887.42		

WIPER MOTORS & PARTS



ILLUSTRATION FOR
1968-86 CJ WIPER ASSEMBLY



1 1968-86 CJ WIPER ASSEMBLY PARTS

DESCRIPTION	PART #
A 1968-86 CJ, WIPER PIVOT NUT	19105.01
B 1968-86 CJ, WIPER PIVOT SPACER	19105.02
C 1968-86 CJ, WIPER PIVOT GASKET	19105.03
D 1976-86 CJ, LONG WIPER PIVOT	19105.04
1976-86 CJ, WIPER LINKAGE KIT (Kit = D, E, F, + (2x)A, B, C, G, R, S)	19105.05
E 1976-86 CJ, SHORT WIPER PIVOT	19105.06
F 1976-86 CJ, WIPER MOTOR LINK	19105.07
G 1968-86 CJ, WIPER ROD CLIP	19105.08
H 1968-86 CJ, WIPER SWITCH NUT	17234.11
I 1968-86 CJ, WIPER SWITCH WASHER	17234.12
J 1968-86 CJ, WIPER MOTOR SWITCH KNOB	13318.05
K 1968-82 CJ, WIPER SWITCH W/ 3 WIRE PLUG MOTOR	19106.01
K 1983-86 CJ, WIPER SWITCH WITH NON-INTERMITTENT WIPER	19106.02
L 1972-86 WIPER WASHER BOTTLE (cap not included)	19107.01
M 1972-86 CJ, WIPER WASHER BOTTLE CAP	19107.02
N 1972-86 CJ & SJ, WASHER PUMP	19108.01
O 1972-86 CJ, WASHER PUMP FILTER	19108.02
P 1972-86 CJ, WASHER PUMP & FILTER KIT	19108.03
Q 1972-86 CJ, WASHER BOTTLE ASSY WITH PUMP & FILTER KIT INCLUDES: BOTTLE, BOTTLE CAP, PUMP & FILTER KIT	19107.03
R 1968-86 CJ, FRONT WIPER ARM, POLISHED	19710.01
R 1968-86 FRONT WIPER ARM, BLACK	19710.02
T 1968-75 CJ, BOTTOM MOUNT WIPER MOTOR	19715.01
T 1976-83 CJ, WIPER MOTOR WITH 3 WIRE PLUG	19715.02
T 1983-86 CJ, WIPER MOTOR WITH 4 WIRE PLUG	19715.03
U 1968-75 CJ, WIPER MOTOR COVER, STAINLESS STEEL	11122.01
U 1976-86 CJ, WIPER MOTOR COVER, STAINLESS STEEL	11122.02
U 1976-86 CJ, WIPER MOTOR COVER, BLACK	19135.01
V 1976-86 CJ, WINDSHIELD WIPER PIVOT PLASTIC COVER (each)	13318.02

2 1941-67 UNIVERSAL WIPER MOTOR KITS (Kit includes: 1 motor, 1 arm & 1 blade)

DESCRIPTION	PART #
UNIVERSAL WIPER MOTOR KIT, 6V	19101.01
UNIVERSAL WIPER MOTOR KIT, 12V	19101.02
UNIVERSAL WIPER MOTOR KIT, 12V STAINLESS	19101.03
UNIVERSAL WIPER MOTOR KIT, 24V	19101.04
SPARE WIPER BLADE & ARM KIT	19102.01

3 O.E REPLACEMENT FRONT WIPER MOTORS

DESCRIPTION	PART #
1987-95 WRANGLER, FRONT WIPER MOTOR	19715.04
1987-95 WRANGLER, WIPER MOTOR GASKET	19716.01
WIPER MOTOR TO WINDSHIELD SEAL	
1993-96 GRAND CHEROKEE, FRONT WIPER MOTOR	19715.06

4 O.E. REPLACEMENT REAR WIPER MOTORS

DESCRIPTION	PART #
1991-95 WRANGLER	19717.01
1984-90 CHEROKEE	19717.02
1991-96 CHEROKEE	19717.03
1993-94 GRAND CHEROKEE	19717.04

5 WIPER ARMS

DESCRIPTION	PART #
1987-95 WRANGLER, FRONT WIPER ARM	19710.03
1987-95 WRANGLER, REAR WIPER ARM	19710.03
1997-02 WRANGLER, REAR	19710.06
1997-06 WRANGLER, FRONT (each)	19710.05
1984-96 CHEROKEE, FRONT	19710.07
1984-96 CHEROKEE, REAR	19710.08
1997-01 CHEROKEE FRONT	19710.13
1997-01 CHEROKEE REAR	19710.14
1993 GRAND CHEROKEE, REAR	19710.10
1993-98 GRAND CHEROKEE, FRONT	19710.09
1994-95 GRAND CHEROKEE (w/o flipper window)	19710.11
1995 GRAND CHEROKEE, ALL 1996 (w/o flipper window)	19710.12
1997-98 GRAND CHEROKEE	19710.12

6 WIPER BLADES

DESCRIPTION	PART #
1968-86 CJ, FRONT WIPER BLADE, 11"	19712.07
1987-95 WRANGLER, REAR WIPER BLADE, 16"	19712.04
1987-06 WRANGLER, FRONT WIPER BLADE, 13"	19712.01
2007-10 WRANGLER, FRONT BLADE, 15" (NEW)	19712.08
1997-06 WRANGLER, REAR BLADE, 18"	19712.02
1984-01 CHEROKEE, FRONT BLADE, 18"	19712.02
1984-01 CHEROKEE, REAR BLADE, 13"	19712.05
1993-04 GRAND CHEROKEE, REAR BLADE, 13"	19712.05
1993-98 GRAND CHEROKEE, FRONT BLADE, 19"	19712.03
1999-06 GRAND CHEROKEE, FRONT BLADE, 21" (NEW)	19712.09
2002-07 LIBERTY, FRONT BLADE, 19"	19712.03

7 WINDSHIELD WASHER PUMPS

DESCRIPTION	PART #
1972-86 CJ	19108.01
1987-89 WRANGLER	19108.04
1997-02 WRANGLER FRONT, REAR	19108.08
1990-95 WRANGLER	19108.05
1987-90 CHEROKEE FRONT	19108.01
1987-96 CHEROKEE REAR	19108.01
1991-96 CHEROKEE FRONT	19108.06
1997-01 CHEROKEE FRONT	19108.08
1997-01 CHEROKEE REAR	19108.07
1993-98 GRAND CHEROKEE	19108.05
1972-86 SJ	19108.01

8 WIPER SWITCHES

DESCRIPTION	PART #
1987-95 WRANGLER, MODELS WITHOUT INTERMITTENT & WITHOUT STEERING TILT	17236.01
1987-95 WRANGLER WITH TILT COLUMN	17236.04
1984-93 CHEROKEE WITHOUT INTERMITTENT & W/O STEERING TILT	17236.01
1984-93 CHEROKEE MODELS WITHOUT INTERMITTENT & WITH TILT STEERING	17236.03

Wipers

REPLACEMENT CHRYSLER MINI VAN PARTS

MINI VAN

DESCRIPTION	PART #	DESCRIPTION	PART #
HOOD 01-07 TOWN & COUNTRY, CARAVAN, VOYAGER	12049.01	RADIATOR HOSE LOWER 3.3L, 3.8L 93-95 CHRYSLER AS BODY	17114.90
FENDER RH 01-07 TOWN & COUNTRY, CARAVAN, VOYAGER	12049.10	RADIATOR HOSE LOWER 2.5L CHRYSLER S-BODY	17114.91
FENDER LH 01-07 TOWN & COUNTRY, CARAVAN, VOYAGER	12049.11	INLET HOSE CHRYSLER NS 2.4L	17115.50
FENDER RH 96-00 TOWN & COUNTRY, CARAVAN, VOYAGER	12049.12	INLET HOSE CHRYSLER NS 3.0L	17115.51
FENDER LH 96-00 TOWN & COUNTRY, CARAVAN, VOYAGER	12049.13	INLET HOSE CHRYSLER NS 3.3L & 3.8L	17115.52
WATER PUMP 82-88 TOWN & COUNTRY, CARAVAN, LEBARON, LASER	17104.70	OUTLET HOSE CHRYSLER NS 2.4L	17115.60
WATER PUMP 2.6L 81-87 TOWN & COUNTRY, CARAVAN	17104.71	OUTLET HOSE CHRYSLER NS 3.3L & 3.8L	17115.61
BELT 3.0L WITH AC 91-92 CHRYSLER AS BODY	17110.85	TIMING BELT 2.4L 97-07 CHRYSLER GS, NS, RS BODY	17453.18
SERPENTINE BELT 2.5L WITH POWER STEERING 93-95 CHRYSLER AS BODY	17111.80	TIMING BELT 2.5L CHRYSLER S/AS-BODY	17453.80
SERPENTINE BELT 2.4L PS CHRYSLER NS 2.4L	17111.81	TIMING BELT 2.5L CHRYSLER S-BODY	17453.81
SERPENTINE BELT 2.4L WITH AC CHRYSLER NS 2.4L	17111.82	ALTERNATOR 120 AMP 91-95 S BODY	17225.80
SERPENTINE BELT 2.4L WITHOUT AC CHRYSLER NS 2.4L	17111.83	STARTER 3.0L 91-95 CHRYSLER AS BODY	17227.80
SERPENTINE COOLING BELT 3.0L W/AC 93-95 CHRYSLER AS BODY	17111.84	IGNITION WIRE SET AS BODY 3.3L	17245.80
SERPENTINE BELT 3.3L, 3.8L 1991 CHRYSLER AS BODY	17111.85	IGNITION WIRE SET 2.5L AS BODY	17245.81
SERPENTINE BELT 3.0L CHRYSLER NS	17111.86	IGNITION WIRE SET AS, NS BODY 3.3L & 3.8L	17245.82
SERPENTINE BELT 3.3L, 3.8L CHRYSLER NS	17111.87	IGNITION WIRE SET 84-91 S BODY 2.2L & 2.5L	17245.83
SERPENTINE BELT 3.3L 3.8L WITH AC 91-97 S BODY	17111.88	IGNITION WIRE SET 84-87 2.6L S-BODY	17245.84
IDLER PULLEY CHRYSLER LS 2.7L, LHS; RS/RG 3.3L & 3.8L; VIPER 03-04 8.3L	17112.08	IGNITION WIRE SET 96-00 2.4L NS BODY	17245.85
TENSIONER ASSEMBLY 91-97 CHRYSLER AS/NS BODY	17112.53	IGNITION WIRE SET 3.0L S & AS BODY	17245.86
TENSIONER CHRYSLER NS 3.3L, 3.8L	17112.54	IGNITION WIRE SET RS 3.3L, 3.8L	17245.87
RADIATOR HOSE UPPER CHRYSLER S-BODY 2.2L, 2.5L	17113.80	IGNITION WIRE SET 3.0 NS	17245.88
RADIATOR HOSE UPPER 2.5L 90-92 CHRYSLER S/AS BODY	17113.81	IGNITION WIRE SET 2.4L RS BODY	17245.89
RADIATOR HOSE UPPER 2.5L 93-95 CHRYSLER AS BODY	17113.82	FRONT HUB, 1995 CHRYSLER LEBARON CONV.	16705.50
RADIATOR HOSE UPPER 3.3L 90-92 CHRYSLER S/AS BODY	17113.83	REAR HUB, 2000-02 PLYMOUTH PROWLER	16705.51
RADIATOR HOSE UPPER 3.0L 93-95 CHRYSLER AS BODY	17113.84	FRONT HUB, 2000-04 CONCORDE, INTREPID, LHS, 300M	16705.51
RADIATOR HOSE UPPER 3.3L, 3.8L WITH HD COOLING 93-95 AS BODY	17113.85	FRONT HUB, 1995-97 STRATUS, CIRRUS, PLYMOUTH BREEZE	16705.52
RADIATOR HOSE UPPER 3.0L CHRYSLER S-BODY	17113.86	FRONT HUB, 1996-99 STERLING CONVERTIBLE	16705.52
RADIATOR HOSE LOWER 3.0 WITH A670 93-95 CHRYSLER AS BODY	17114.80	FRONT HUB, 1992-95 ALL MINI-VAN W/ 15" WHEEL	16705.53
RADIATOR HOSE UPPER 3.3L, 3.8L 93-95 CHRYSLER AS BODY	17114.81	FRONT HUB, 1996-00 ALL MINI-VAN W/ 14" WHEEL	16705.54
RADIATOR HOSE LOWER 3.0L CHRYSLER NS	17114.82	FRONT HUB, 1997-04 ALL MINI-VAN W/ 15" or 16" WHEEL	16705.53
RADIATOR HOSE LOWER 2.5L 91-92 CHRYSLER AS BODY	17114.83		
RADIATOR HOSE LOWER 2.5L 93-95 CHRYSLER AS BODY	17114.84		
RADIATOR HOSE LOWER 3.0 89 S-BODY	17114.85		
RADIATOR HOSE LOWER 3.0L WITH A604 93-95 CHRYSLER AS BODY	17114.86		
RADIATOR HOSE LOWER 3.0L WITH A670 90-91 CHRYSLER S/AS BODY	17114.87		
RADIATOR HOSE LOWER 3.0L WITH HD COOLING 93-95 CHRYSLER AS BODY	17114.88		
RADIATOR HOSE LOWER 3.3L 91-92 CHRYSLER AS BODY	17114.89		

AS	1991-1995	Town & Country, Caravan, Voyager
LH	1993-2004	New Yorker, Concorde, LHS, 300M, Intrepid, Vision
NS	1996-2000	Town & Country, Caravan, Voyager
RG	2001-2006	Town & Country, Caravan, Voyager (Export)
RS	2001-2007	Town & Country, Caravan, Voyager
S	1984-1990	Town & Country, Caravan, Voyager

CHEROKEE - CJ - WRANGLER

The legend of the "Jeep" in a crate has been around for years. Nobody has been able to prove this legend until now. Hundreds of surplus crates containing CJ - Cherokee - and even Wrangler parts from all over the globe, have been sourced and brought to our warehouse. Each crate contains just one piece to a puzzle of a thousand parts that make up any number of Jeep® systems or even complete vehicles.

JEOP CHEROKEE (RHD)

We have thousands of OE high quality factory fresh replacement parts for your 1984-96 Jeep® Cherokee. These crates were packed at the Toledo factory in 1996 for the export of 288 Cherokees to be assembled in an overseas market. All items were packed in bulk and have been sealed in their crates for the past ten years. All parts look like the day they came off the assembly line here in the U.S. and Canada. All of the surplus parts were either manufactured here in the States or in Canada and are of true OE quality. Looking for that replacement axle assembly? We have it. Looking for that small bolt or fastener that's just not stocked anymore? We have it. If it was made for the first generation Cherokees, then odds are we have what you are looking for.

CJ & WRANGLER SURPLUS

As with the Cherokee stock we have acquired a large number of crates containing many CJ and Wrangler components. The crates are being opened and new stock is being readied for sale daily. Items range from transmissions to mirrors and many more items you will find listed in the following pages of this catalog.

For complete listing, please visit our website.

SURPLUS



Please keep in mind that even though there is a large supply of these surplus parts, quantities are limited. When the part you need sells out, it's gone for good. For this reason, we are selling on a first come, first serve basis.



Surplus

SURPLUS

CHRYSLER-JEEP® TRANSMISSIONS

The following transmissions were originally supplied for 1996 export Cherokee vehicles, but can be used for any Jeep® application where they were installed by the factory.



S-52108046

AX5 Manual Transmission

Used with Cherokee 2.5L 4 cylinder engine.

- Jeep® models that used the AX5 manual transmission
- 1994-96 Cherokee with 2.5L 4 cylinder engine
- 1984-93 Cherokee with 2.5L 4 cylinder engine (may require modifications)
- 1987-98 Wrangler with 2.5L 4 cylinder engine (may require modifications)



S-4810179

AW4 Automatic Transmission used with 4.0L High Output engines, and has a 23 spline output shaft. Gear ratios were 2.80, 1.53, 1.00, and .75

- Jeep® models that used the AW4 automatic transmission
- 1991-96 Cherokee (XJ), Comanche pick-ups (MJ) 6 cylinder
- 1993 Grand Cherokee (ZJ) 6 cylinder



S-52119156

32RH Automatic Transmission

with 23-spline output used with 4.0L 6 cylinder engines.

This automatic transmission was originally supplied for 1994-96 export Wrangler with 4.0L 6 cylinder engines, but can be used for any Jeep® application where part number 52118024 was installed by the factory.

- Jeep® models that used the 32RH automatic transmission
- Jeep® part number S-52118024
- 1992-95 Wranglers with 4.0L 6 cylinder engine
- 1996 Export Wrangler with 4.0L 6 cylinder engine

RELATED SURPLUS TRANSMISSION & TRANSFER CASE PARTS

DESCRIPTION	PART #
BELL HOUSING 1997-00 CHEROKEE 2.5L MANUAL	S-52104000
BELL HOUSING 1987-93 4.0L MANUAL	S-53007105
TRANSMISSION CUSHION 1984-86 CHEROKEE V6	S-52001180
1997-98 CHEROKEE 2.5L 231 TRANSFER CASE LEVER ASSEMBLY	S-52104101AB
1997-98 CHEROKEE 4.0L 242 TRANSFER CASE LEVER ASSEMBLY	S-52104103
CHEROKEE 4.0L AUTOMATIC SHIFT LEVER 1996 AW4	S-52104107

ALL SURPLUS EQUIPMENT IS OF A LIMITED SUPPLY AND WILL BE SOLD ON A FIRST COME FIRST SERVE BASIS ONLY.

CHRYSLER-JEEP® TRANSFER CASES

The following transfer cases were originally supplied for 1996 export Cherokee vehicles, but can be used for any Jeep® application where they were installed by the factory.



S-52099310

NP231 (S-52099310) Chain drive transfer case

For 2.5L 4 cylinder with manual transmissions.

Has a 21-spline input, and a 1.2" short shaft.

- Jeep® models that used the NP231 21-spline transfer case.
- Any 4 cylinder Jeep with an AX4, or AX5 manual transmission
- Any 4 cylinder Jeep with an AW4 up to 1990 with 21-spline output.



S-52098384

NP242 (S-52098384) Chain drive full time transfer case (Export Only)

For 4.0L 6 cylinder engines, 23-spline input.

- Jeep® models that used the NP242 23-spline full time transfer case.
- 1991-01 Jeep Cherokee with 4.0L 6 cylinder engine and A/T
- Uses 2 wire transfer indicator switch
- 2WD-4PT-4FT-N-4L Shift Pattern

The following transfer cases were originally supplied for 1994-96 export Wranglers with 4.0L 6 cylinder engines, but can be used for any Jeep® application where the listed part numbers were installed by the factory.



S-52098360



S-52098358

NP231 (S-52098358) Chain drive transfer case

For 4.0L 6 cylinder with manual transmissions, 23-spline input, (1.2" short shaft).

- Jeep® models that used the NP231 23-spline transfer case with manual transmission and some automatics
- Any 6 cylinder Jeep® equipped with a 1989-94 AX15
- Any 6 cylinder Jeep® equipped with an AW4 after 1990, 23-spline output

NP231 (S-52098360) Chain drive transfer case

For 4.0L 6 cylinder with automatic transmissions, 23-spline input, (2.1" long shaft).

- Jeep® models that used the NP231 23-spline transfer case with automatic transmission and some manual transmission
- Any 6 cylinder Jeep® equipped with a 1996-01 AX15
- Any 6 cylinder Jeep® equipped with a 31RH or 32RH automatic

CHRYSLER-JEEP® FRONT AND REAR AXLE ASSEMBLIES (Surplus Limited Supply)

The following axle assemblies were originally supplied for 1996 export right hand drive Cherokee vehicles, but can be used for any Jeep® application where they were installed by the factory.

S-52069795 Dana 35 rear axle assembly with 3.54 gears

- Jeep® models that can use the Dana 35 axle.
- 1984-01 Jeep Cherokee
 - Comanche pick-up
 - Any Wrangler or Grand Cherokee with rear leaf spring design (some modifications required).

Axles come with leaf spring mounting perches

S-52069381 Chrysler 8.25 rear axle assembly w/ 4.10 gears w/ Track-Lok

- Jeep® models that can use the 8.25 rear axle.
- 1984-01 Jeep Cherokee
 - Comanche pick-up
 - Any Wrangler or Grand Cherokee with rear leaf spring design.

Axles come with leaf spring mounting perches



The front axle assembly was exported as a RHD unit but can be used domestically w/ modifications.

RHD = right hand drive vehicle.

S-52069201 High Pinion Dana 30 front assembly with 4.10 gears.

RIGHT HAND DRIVE (RHD)

S-52069200 High Pinion Dana 30 front assembly with 3.54 gears.

RIGHT HAND DRIVE (RHD)

Jeep® models that had a coil spring Dana 30 front axle. 1994-01 (RHD) Jeep Cherokee (XJ)

Note: these front axle assemblies can be modified to work w/ other front applications (LHD) but will require some cutting and rewelding.

RELATED SURPLUS AXLE & DRIVELINE PARTS CHEROKEE

DESCRIPTION	PART #
1994-99 DRIVESHAFT REAR 4.0L AUTO	S-52098731
1996-99 DRIVESHAFT REAR 2.5L MAN	S-52098744
1987-00 DRIVESHAFT FRONT 2.5L MAN	S-53005541
1984-01 FRONT SPRING COIL	S-52001124
1996 FRONT SHOCK	S-52087831
1994-01 FRONT SWAY BAR	S-52087859
1992-01 REAR SWAY BAR	S-52001135
1984-01 FRONT COIL SPRING INSULATOR	S-52000229



JEEP® CHEROKEE BODY PARTS (Surplus Limited Supply)



1 BUMPER

DESCRIPTION	PART #
1984-96 Front bumper (black) 2 door & 4 door	S-55234551
1984-96 Front bumper (no paint) 2 door & 4 door	S-55234549
1984-96 Rear bumper (no paint) 2 door & 4 door	S-55234617

2 GRILLE

DESCRIPTION	PART #
1991-96 Front grille support 2 door & 4 door	S-55294926

3 COWL

DESCRIPTION	PART #
1984-96 Cowl filter screen (RHD only)	S-55027697
1984-96 Cowl Grille (RHD only)	S-55027696

4 HOOD

DESCRIPTION	PART #
1984-01 Hood, 2 door & 4 door model Cherokee	S-55235439
1984-01 Hood hinge, right side	S-55075180
1984-01 Hood hinge, left side	S-55075181
1984-96 Hood (bonnet) release cable assembly	S-55075570

5 BODY SIDE PANELS

DESCRIPTION	PART #
1984-96 Left side body panel (4 door models)	S-55235339
1984-96 Right side body panel (4 door models)	S-55235338

6 DOORS

DESCRIPTION	PART #
1984-96 Front left (driver's) door (4 door models)	S-55235251
1984-96 Front right (passenger's) door (4 door models)	S-55235250
1984-96 Rear left (driver's) door (4 doors models)	S-55176003
1984-96 Rear Right (passenger's) door (4 door models)	S-55176002

7 ROOF & FLOOR

DESCRIPTION	PART #
1984-96 Roof panel w/roof rack mounting holes 2&4dr	S-55254639
1995-96 Front floor pan 2 door & 4 door Cherokee	S-55174807
1993-96 Rear floor pan 2 door & 4 door Cherokee	S-55235380

8 FRAME

DESCRIPTION	PART #
1984-96 Crossmember assembly 2 door & 4 door	S-52003228
1984-96 Front skid plate	S-52018009

9 REAR LIFTGATE

DESCRIPTION	PART #
1984-96 Rear liftgate (composite) 2 door & 4 door	S-55235531
1984-96 Rear liftgate hinge left side	S-55075295
1984-96 Rear liftgate hinge right side	S-55075294

10 HEAD LAMP

DESCRIPTION	PART #
1984-96 RH head lamp (Hella H4 55W-60W) w/o level device	S-55054828
1984-96 LH head lamp (Hella H4 55W-60W) w/o level device	S-55054829

11 FRONT SIGNAL LAMP

DESCRIPTION	PART #
1984-96 Front signal lamp, RH (amber, export only)	S-55155072
1984-96 Front signal lamp, LH (amber, export only)	S-55155073
1984-96 Front fender turn signal (export only)	S-55055014
1984-96 Front parking lamp, LH (amber, export only)	S-56000853
1984-96 Front parking lamp, RH (amber, export only)	S-56000852

12 REAR SIGNAL LAMP

DESCRIPTION	PART #
1984-96 Rear lamp assy, right side (export)	S-55155464
1984-96 Rear lamp assy, left side (export)	S-55155465
1996 Rear stop light, center mount	S-5ED63PS1

13 EXTERIOR TRIM

DESCRIPTION	PART #
1984-96 Window seal, rear quarter (4 door)	S-55007129
1994-01 Front windshield molding	S-55235391
1984-96 Roof rack assembly 2 door and 4 door	S-55235277

14 FENDERS

DESCRIPTION	PART #
1984-01 RH	S-55235216
1984-01 LH	S-55235217



S-55029245



2

S-5AB98JS1



5



8

S-55154734



9

S-5FG76SS1



3

S-55000766

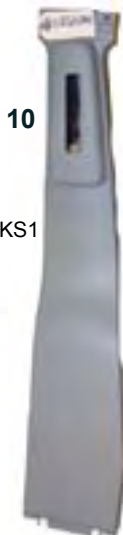

10

S-5BG07KS1



6

S-5FN38SSA



7

S-5EY13SA8



11

S-55114998



12

S-5FM76SA8

1 BUMPER END CAPS

DESCRIPTION	PART #
1984-96 Front left bumper end cap (black grain texture)	S-55234545
1984-96 Front right bumper end cap (black grain texture)	S-55234544
1984-96 Rear left bumper end cap (black grain texture)	S-55029245
1984-96 Rear right bumper end cap (black grain texture)	S-55029244
1984-96 Rear left bumper end cap (gray, smooth)	S-55234691
1984-96 Rear right bumper end cap (gray smooth)	S-55234690

2 FENDER FLARES

DESCRIPTION	PART #
1984-96 Front fender flare right side smooth (paintable)	S-55175482
1984-96 Front fender flare left side smooth (paintable)	S-55175483
1984-96 Rear fender flare right side smooth (paintable)	S-55005879
1984-96 Rear fender flare left side smooth (paintable)	S-55005878

3 DOOR LATCH

DESCRIPTION	PART #
1984-96 Door latch assembly, right side (front)	S-55000766
1984-96 Door latch assembly, left side (front)	S-55000767
1984-96 Door latch assembly, right side (rear)	S-55075878
1984-96 Door latch assembly, left side (rear)	S-55075879

5 ARM RESTS

DESCRIPTION	PART #
1984-96 Front right arm rest w/ pull handle (light gray)	S-5AB98JS1
1984-96 Front left arm rest w/ pull handle (light gray)	S-5AB99JS1
1984-96 Rear arm rest for left & right 4dr (light gray)	S-5AC34JS1
1984-96 Front right arm rest w/ pull handle (dark gray)	S-5AB98JA8
1984-96 Rear arm rest for left & right 4dr (dark gray)	S-5AC34JA8

6 DOOR TRIM

DESCRIPTION	PART #
1984-96 Front door panel right side (gray)	S-5FN38SSA
1984-96 Front door panel left side (gray)	S-5FN39SSA
1984-96 Wood grain door trim, right rear (gray)	S-5DD70MS1
1984-96 Wood grain door trim, left rear (gray)	S-5DD71MS1
1984-96 Wood grain door trim, right front (gray)	S-5DD66MS1
1984-96 Wood grain door trim, left front (gray)	S-5DD67MS1

7 DASH

DESCRIPTION	PART #
1984-96 Dash pad assembly (RHD only)	S-5EY13SA8
1984-96 Wood grain instrument bezel (RHD)	S-55115072
1984-96 Black instrument bezel (RHD)	S-55115070
1995-96 Leather wrapped steering wheel w/o air bag	S-5FJ14SX9

8 MIRRORS

DESCRIPTION	PART #
1984-96 Right side mirror (RHD only)	S-55154683
1984-96 Left side mirror (RHD only)	S-55154734

9 VISOR

DESCRIPTION	PART #
1984-96 RHD Front visor w/ Light (left side)	S-5FG76SS1
1984-96 RHD Front visor w/ Light (right side)	S-5FK76SS1

10 B-PILLAR TRIM

DESCRIPTION	PART #
1984-96 B-pillar upper cover, driver side (gray)	S-5BG07KS1
1984-96 B-pillar upper cover, passenger side (gray)	S-5BG06KS1
1984-96 B-pillar lower cover, driver side (gray)	S-5EU70RS1
1984-96 B-pillar lower cover, passenger side (gray)	S-5EU71RS1

11 CONSOLE

DESCRIPTION	PART #
1984-96 Center console insert (Black) 2dr and 4dr	S-55114998
1984-96 Center console (gray) 2dr and 4dr	S-5FG26SA8

12 CARGO AREA

DESCRIPTION	PART #
1984-96 Rear cargo cover assemble (gray)	S-5FC34RS1
1984-96 Spare tire cover (gray)	S-5FM76SA8
1984-96 Rear scuff cover (gray)	S-5AC55JS1

JEEP® CHEROKEE HARD PARTS (Surplus Limited Supply)

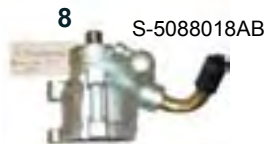
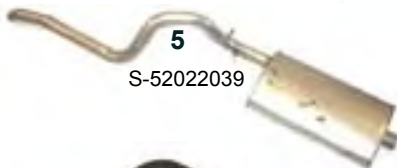

1 COOLING SYSTEM

DESCRIPTION	PART #
1996 Fan Shroud 4.0L 6 cyl (RHD)	S-52028324
1996 Fan (7 blades)	S-52028603
1996 Electric fan assembly (RHD)	S-52030035AB
1996 Coolant bottle assembly RHD (export)	S-52079340

5 EXHAUST PARTS

DESCRIPTION	PART #
1996 Muffler assembly with tail pipe, 4.0L 6 cyl	S-52022039
1984-96 OE exhaust pipe clamp	S-52018424
1984-96 OE exhaust insulator	S-52001759
1996-99 4.0L Front exhaust pipe	S-52020069

2 ELECTRICAL PARTS - DRIVE TRAIN

DESCRIPTION	PART #
1993-96 Sensor (HI-TEMP)	S-56027012
1996 ignition wires 2.5L 4 cyl (4pcs)	S-56027219
1996 Speed control assembly	S-52079347
1996-97 Speed control switch assembly	S-56007712

6 HEATING & A/C PARTS

DESCRIPTION	PART #
1996 A/C Condenser	S-55036779
1992-96 Vacuum reservoir	S-52004366
1984-96 Dash mount A/C vent control assembly (RHD)	S-56022016
1994-96 A/C receiver - drier	S-55036112
1994-96 2.5L & 4.0L A/C compressor R-134	S-55037359
1994-01 CHEROKEE 2.5L RHD A/C compressor R-134	S-55037360

3 ELECTRICAL PARTS - GENERAL

DESCRIPTION	PART #
1993-00 Switch & bezel (window) right rear	S-56007218
1993-00 Switch & bezel (window) left rear	S-56007221
1984-96 Switch assy (window, door) left front (RHD)	S-56007223
1984-96 Switch assy (window, door) right front (RHD)	S-56010051
1984-96 Instrument cluster (RHD, Kilometers)	S-56009018
1992-96 Power window regulator, front left side	S-55235647
1992-96 Power window regulator, front right side	S-55235646
1994-96 Power window regulator, rear left side	S-55154899
1994-96 Power window regulator, rear right side	S-55154898
1984-96 Power antenna assembly	S-56003151
1984-96 Washer reservoir with two pumps	S-55155318
1984-96 Wiper motor assembly RHD with linkage	S-55155300
1984-00 Power door solenoid right side	S-J3721500
1984-00 Power door solenoid left side	S-J3721501
1997-02 2.5L Crankshaft Position Sensor	S-56027867
1997-05 4.0L Crankshaft Position Sensor	S-56027867

7 FUEL & INTAKE SYSTEM PARTS

DESCRIPTION	PART #
1996 Fuel tank without sending unit	S-56022095
1994-96 Fuel pump with regulator & sending unit (in tank)	S-4798941
1984-96 Fuel tank skid plate	S-52001512
1996 Filter box air hose assembly	S-53006274
1997-00 Vapor return canister	S-53031904

8 STEERING PARTS

DESCRIPTION	PART #
1995-96 Steering assembly (intermediate)	S-52078556
1991-01 CHEROKEE RHD Pitman arm (power steering)	S-52006505
1991-01 CHEROKEE RHD Steering stabilizer shock	S-52037506
1996 Steering column assembly - tilt	S-52080229
1997-01 Power steering box - RHD only	S-56022278AA
1995-96 AirBag (steering wheel, black) ***	
***EXPORT ONLY, CAN NOT BE SOLD DOMESTICALLY	S-5FL22SX8
1984-96 Steering linkage assembly - RHD	S-52006507
1996 Steering wheel without air bag	S-5FJ14SX9

4 BRAKE PARTS

DESCRIPTION	PART #
1996 Power brake booster with master cylinder	S-52008647
1996 Hydraulic ABS control unit	S-52008727
1996-99 Proportioning valve assembly	S-52129025
1996 E-brake lever assembly (2.5L - manual)	S-52127958

JEEP® CJ & WRANGLER SURPLUS STOCK (Limited Supply)

Spotlight Surplus item

OE steel wheel for 1987 to 2006 Jeep vehicles with 5 x 4.5 wheel bolt pattern. These are factory supplied steel wheels that can be used as your second set of street wheels, or for your set of winter tires. Need to save space and weight? Then this is your ideal rim. The 15" x 6" design allows for both weight and space savings. Order today for an unbelievable deal while supplies last. (P/N: **S-52000022**)

Help dress the wheels up with a Jeep® hub cap (P/N: **S-52089008**)

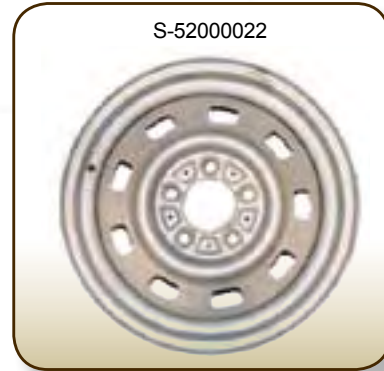

Is the front of your CJ sagging with all you extra gear, or just slumping due to age. Try replacing them with these heavy duty 7 layer military wrapped front springs for 1976-86 CJ's.
P/N : **S-J5364230**

Time, heat, cold, and water can damage your hard top side vent windows. We have both left and right side vent windows in stock. Hurry because these will not last long.
S-55176281 (LH)
S-55176280 (RH)



MISC. PARTS

DESCRIPTION	PART #
LUG WRENCH WRANGLER, 3/4"	S-52003583
1987-95 FRONT PROP SHAFT (6 CYL) W/ AUTOMATIC	S-52088028
1987-06 HUB CAPS W/ JEEP LOGO FOR STEEL WHEEL	S-52089008
1994-96 NP231 TRANSFER CASE 23 SPLINE INPUT (4.0L) MANUAL	S-52098358
1994-96 NP231 TRANSFER CASE 23 SPLINE INPUT (4.0L) AUTO	S-52098360
1994-96 AUTOMATIC TRANS. ASSY. (4.0L)	S-52119156
IDLER PULLEY (fits many applications)	S-53002903
1993-95 4.0L WRANGLER, FRONT EXHAUST PIPE	S-52018176
INSIDE REAR VIEW MIRROR (fits many applications)	S-55009784
1991-96 4.0L WRANGLER, OXYGEN SENSOR	S-56028301
1991-99 4.0L WRANGLER, FAN CLUTCH	S-52027626
1991-95 2.5L WRANGLER, FAN CLUTCH	S-52027626
HEATER ASSEMBLY WITH BLOWER MOTOR WRANGLER	S-55036899
1987-95 WRANGLER CARPET FRONT FLOOR, AUTOMATIC CINDER (GRAY) COLOR	S-5EE05PXA
1987-95 WRANGLER FLOOR PAN TRANSMISSION TUNNEL COVER (automatic)	S-53004650
HD FRONT LEAF SPRING W/ MILITARY WRAP 7 LAYER FOR CJ	S-J5364230
1972-05 DETROIT TRUTRAC LIMITED SLIP FOR DANA 30 (2.73-3.54 ratios)	S-TT-912374
1991-95 WRANGLER FULL DOOR INNER PANEL (GRAY) LEFT SIDE	S-5AE13KXA
1987-95 WRANGLER WITHOUT A/C, VENT CONTROL ASSEMBLY	S-55036371
1987-95 WRANGLER KDX FRAME CROSS MEMBER	S-52002727
1987-06 5" X 4.5" X 6" STEEL OE WHEEL	S-52000022
1987-95 WRANGLER UPPER VENT CONTROL ASSEMBLY	S-55037200
1987-95 WRANGLER TRANSFER CASE SHIFTER LEVER	S-53003044
1987-95 WRANGLER HEAVY DUTY REAR SHOCK	S-83502837
1987-95 WRANGLER HEAVY DUTY FRONT SHOCK	S-83502836



S-55036899



S-55036371

Is your front drive shaft worn out? Do you have a bad vibration any time you shift into 4WD? Then your drive shaft could be the problem. We have a large supply of front and rear surplus drive shafts for many applications.



S-52088028 Wrangler front drive shaft with automatic transmission



S-52098221 rear drive shaft for 4.0L manual transmission

ALL SURPLUS EQUIPMENT IS OF A LIMITED SUPPLY AND WILL BE SOLD ON A FIRST COME FIRST SERVE BASIS ONLY.

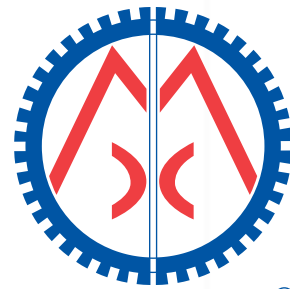

OMIX-ADA®



S-5EY13SA8



S-55027697



S-55155465

S-55155464



S-55155300



S-55034395



S-55154683



S-55154734



S-52030035AB



S-52006508



S-52040110



S-55176280 S-55176281

**JEEP® RHD & EXPORT SURPLUS STOCK
(Limited Supply)**

DESCRIPTION	PART #
1984-96 FRONT TRACK BAR BRACKET(RHD) CHEROKEE	S-52006508
1984-96 COWL FILTER SCREEN (RHD ONLY)	S-55027697
1984-96 COWL GRILL (RHD ONLY)	S-55027696
1984-96 RIGHT SIDE MIRROR (RHD ONLY)	S-55154683
1984-96 LEFT SIDE MIRROR (RHD ONLY)	S-55154734
1984-96 REAR LAMP ASSY, RIGHT SIDE (EXPORT ONLY)	S-55155464
1984-96 REAR LAMP ASSY, LEFT SIDE (EXPORT ONLY)	S-55155465
1984-96 FRONT FENDER TURN SIGNAL (EXPORT ONLY)	S-55055014
1984-96 RH HEAD LAMP (HELLA H4 55W-60W)	
W/O LEVEL DEVICE	S-55054828
1984-96 LH HEAD LAMP (HELLA H4 55W-60W)	
W/O LEVEL DEVICE	S-55054829
1984-96 DASH PAD ASSEMBLY (RHD ONLY)	S-5EY13SA8
1984-96 WOOD GRAIN INSTRUMENT BEZEL (RHD)	S-55115072
1984-96 BLACK INSTRUMENT BEZEL (RHD)	S-55115070
1996 FAN SHROUD 4.0L 6 CYL (RHD)	S-52028324
1996 ELECTRIC FAN ASSEMBLY (RHD)	S-52030035AB
1996 COOLANT BOTTLE ASSEMBLY RHD, (EXPORT ONLY)	S-52079340
1984-96 SWITCH ASSEMBLY (WINDOW, DOOR) LH FRONT (RHD)	S-56007223
1984-96 SWITCH ASSEMBLY (WINDOW, DOOR) RH FRONT (RHD)	S-56010051
1984-96 INSTRUMENT CLUSTER (RHD, KILOMETERS)	S-56009018
1984-96 WIPER MOTOR ASSEMBLY, RHD	S-55155300
1997-01 POWER STEERING BOX, RHD ONLY	S-56022278AA
1995-96 AIRBAG (STEERING WHEEL, BLACK) EXPORT ONLY, yeahCANNOT BE SOLD DOMESTICALLY	S-5FL22SX8

**JEEP® WRANGLER SURPLUS STOCK
(Limited Supply)**

DESCRIPTION	PART #
1987-95 PITMAN ARM, LHD WRANGLER W/ MANUAL STEERING	S-52040110
1994-95 REAR DRIVE SHAFT (4.0L) WRANGLER W/ MAN TRAN AND 3 INCH SLIP YOKE	S-52098221
1987-95 WRANGLER 6-CYL W/ AX15 MANUAL TRAN, FLYWHEEL HOUSING	S-53007105
1981-96 CJ, WRANGLER WORLD CAB, DOOR RIGHT SIDE R	S-55034394
1981-96 CJ, WRANGLER WORLD CAB, DOOR LEFT SIDE	S-55034395
1987-95 WRANGLER COWL GRILL W/ SCREEN	S-55175729
1987-95 WRANGLER CENTER CONSOLE, GRAY	S-5ER64RXA
1991-95 WRANGLER HARDTOP SIDE VENT WINDOW - LH	S-55176281
1991-95 WRANGLER HARDTOP SIDE VENT WINDOW - RH	S-55176280
1987-95 WRANGLER GRILL AIR DEFLECTOR TOP, SIDES	S-55027504
1987-95 TEMP CONTROL CABLE ASSEMBLY	S-55036907

OMIX-ADA® LIMITED WARRANTY

3 THREE YEAR MANUFACTURER WARRANTY

If your product is purchased from Omix-Ada® and is not separately warranted by either Omix-Ada® or the manufacturer, then this Limited Warranty gives you specific legal rights and is the only warranty OMIX-ADA® makes in connection with your purchase.* OMIX-ADA® neither assumes nor authorizes any manufacturer, vendor, retailer, other person or entity to assume for it any other obligation or liability in connection with its products or this Limited Warranty.

What Is Covered? Subject to the terms, exclusions and limitations herein and with respect only to products first sold in the United States, OMIX-ADA® warrants to the initial retail purchaser ("purchaser") only that when installed and used on purchaser's vehicle according to supplied product installation instructions and/or warnings, purchaser's OMIX-ADA® product shall be free of defects in material and workmanship for three (3) years. This Limited Warranty shall be measured from the date of initial retail purchase, extends only to the initial retail purchaser and is not transferable. ALL OTHER EXPRESS OR IMPLIED WARRANTIES ARE HEREBY DISCLAIMED, INCLUDING BUT NOT LIMITED TO IMPLIED WARRANTIES OR MERCHANTABILITY OR FITNESS FOR A PARTICULAR PURPOSE. Your warrantor for these parts is OMIX-ADA®, Inc, 460 Horizon Dr., Suite 400 Suwanee, GA 30024(770/614-6101). OMIX-ADA® reserves the right to: (a.) require proof of purchase as a condition of this Limited Warranty-please use warranty registration card, (b.) make future revisions to this product or it's Limited Warranty without obligation to conform existing product or provide purchaser with prior notice.

What Is Not Covered? Your OMIX-ADA® Limited Warranty does not cover damage or claims to any component, vehicle or person other than the OMIX-ADA® product purchased. Your Limited Warranty does not cover damage or claims to any component, vehicle or person OMIX-ADA® determines to have been damaged by or subjected to:

- Inadequate mounting or installation, water, alteration, modification, misuse or failure to maintain.
- Damage in any part attributable to: (a.) vehicle systems or components (including electronic stability control) or (b.) combination with non-OMIX-ADA® products.
- Normal wear and tear/product deterioration.
- Scratches or defects in product finishes or damage due to shipping.
- Accidents, impact by rocks, trees, obstacles or other aspects of the use environment.
- Theft, vandalism or other negligent or intentional damage.

Remedy Limited to Repair / Replacement. The exclusive remedy provided for products covered under this Limited Warranty shall be, upon OMIX-ADA®'s inspection and at OMIX-ADA®'s option, either repair, replacement (with OMIX-ADA® supplied parts) or refund for the product purchase price. Any parts repaired or replaced will be considered part of the original product and will not extend the term of Limited Warranty. Customers requesting warranty consideration should first contact the independent distributor selling your product to obtain a Returned Goods Authorization number. All removal, shipping and installation costs are customer's responsibility. If a replacement part is needed before your part can be returned, you must first purchase the replacement part. Then, if OMIX-ADA® determines the part warrantable, you will be credited the purchase price of that part.

Other Limitations - Exclusion of Damages - Your Rights Under State Law

- In consideration of the purchase price paid, neither OMIX-ADA® nor any independent distributor are responsible for any loss of use or time, rental costs, or for any incidental, consequential, punitive or other damages (whether arising in tort or contract) you may have or incur in connection with your vehicle, or your OMIX-ADA® product. Your exclusive remedy hereunder is, at OMIX-ADA®'s option, repair/replacement or refund as described above.
- This Limited Warranty gives you specific rights. You may also have other rights that vary from state to state. For example, while all implied warranties are disclaimed herein, any implied warranty required by law is limited to the duration and other enforceable terms of Limited Warranty described above. Some states do not allow limitations of how long an implied warranty lasts and /or do not allow the exclusion or limitation of incidental or consequential damages, so the limitations and exclusions herein may not apply to you.

* See exclusive Limited Warranty Terms included with Rugged Ridge® suspension, Winches, wheels, floor liners, Alloy USA® axles/gears and other OMIX-ADA® products at www.omix-ada.com.

© OMIX-ADA®, Inc. 2010. All rights reserved.



**Rugged
Ridge**

Index

A/C Compressors	212	Crankshaft Gears	199	Exhaust Valves	200	Leaf Spring Bushings	218-219	Starters	191
A/C Condensers	212	Crankshaft Oil Seals	197	Fan Belts	187	Leaf Springs	218-219	Steel Dash Panels	141
A/C Driers	212	Crankshaft Pilot Bearings	197	Fan Clutches	185	Liftgate Support Struts	157-158	Steering Box Brace	155
A/C Evaporators	212	Crankshaft Position Sensors	189	Fan Shrouds	185	Liftgate Supports	155	Steering Boxes	213
ABS Speed Sensors	190	Crankshaft Pulleys	199	Fender Flares	140, 148, 151-153	Cover Lower Gasket Sets	197	Steering Column Seals	215
Accelerator Cables	207	Crankshafts	198	Fender Supports	156	Lower Radiator Hoses	187	Steering Columns	215
Accelerator Pedals	207	Crossmembers	143, 145, 150, 156	Fenders	142-158	Lug Nuts	174	Steering Dampers	215
Air Cleaner Assemblies	208	Cup Holders	141	Firewall	147	Main Bearing Sets	198	Steering Gear Box Brackets	213
Air Cleaner Brackets	208	CV Boots	170	Firewall Plates	151	Main Shafts	226-231	Steering Gear Box Seals	213
Air Cleaner Horns	208	Cylinder Head Gaskets	197	Flares	140, 148, 151-153	Manual Steering Gear Boxes	213	Steering Gear Box Sector Shafts	213
Air Filters	208	Cylinder Heads	197	Flashers	135, 192	Manual Trans.	225-231, 234	Steering Gear Box Worm Shafts	213
Air Horn	147	Dana 18	221	Flex Plates	182, 202	MAP Sensors	189	Steering Knuckles	215
Aisin AX15	231	Dana 20	222	Floor Panels	142-151	Master Cylinder Cover Plate	143-144	Steering Shaft Couplings	215
Aisin AX4/AX5	230	Dana 25 & 27	159	Flywheel Ring Gears	202	Master Cylinders	172	Steering Shafts	215
Alternators	191	Dana 27	164	Flywheels	182, 202	Mirrors	157	Steering Wheels	214
AMC Model 20	166	Dana 30	160-162	Fog Lights	134	Mufflers	206	Sun Visors	141
Ammeters	188	Dana 300	223	Footman Loops	138, 143, 145, 147	Multifunction Switches	192	Sway Bar End Links	220
Antennas	195	Dana 35	167	Footrests	143	New Process 231	224	Synchronizers	225-231
Armatures	191	Dana 44	159, 164-165	Frame Parts	143	Oil Caps	196, 201	Tachometers	188
Automatic Transmission	234	Dana Super 30/186	163	Front Hubs	173	Oil Dip Sticks	201	Tail Light Panels	151
Automatic Transmission Filters	229	Dash Indicator Lights	141	Front Pipes	204	Oil Filters	201	Tail Lights	135
Automatic Trans Rebuild Kits	229	Dash Parts	141	Fuel Filler Hoses	211	Oil Gauges	188	Tail Panels	147
Axe Brackets	143, 145	Dash Plates	151	Fuel Filler Necks	211	Oil Pan Drain Plugs	201	Tailgate Locks	139
Axe Assemblies Surplus	235	Dashpads	133, 141, 150	Fuel Filters	211	Oil Pan Gaskets	201	Tailgates	133, 144-152
Axe Bearings	159-164	Defrost Ducts	212	Fuel Gauges	188, 209	Oil Pressure Sending Units	157	Tailpipes	206
Axe Conversion Kits	166	Degree Wedges	219	Fuel Injectors	209	Oil Pumps	201	Temperature Gauges	188
Axe Disconnects	161	Differential Bearings	159-164	Fuel Lines	209	Outer Door Handles	139, 155, 157	Temperature Sending Units	189
Axe Dust Caps	166	Differential Cases	159-169	Fuel Modules	209	Outer Tailgate Handles	139	Temperature Sensors	189
Axe Shafts	159-169	Differential Covers	159-169	Fuel Pressure Regulators	209	Oxygen Sensors	158	Thermostat Gaskets	186
Axe Snubbers	218	Differential Shims	165-166	Fuel Pumps	209	Parking Lights	135	Thermostat Housings	186
Back Panels	142	Dimmer Switches	192	Fuel Tank Sending Units	210	PCV Valves	196, 208	Thermostats	186
Back-Up Lights	135	Disc Brake Caliper Anti-Rattle Clips	178	Fuel Tank Straps	210	Pedal Pads	180	Throttle Cables	207
Ball Joints	215	Disc Brake Caliper Bleeder Screw	178	Fuel Tank Vent Hoses	211	Peugeot BA 10/5	229	Throttle Position Sensors	190
Battery Trays	195	Disc Brake Caliper Bolts	178	Fuel Tanks	142, 145, 147, 210	Pilot Bearings	182	Tie Rod Ends	216-217
Bellcranks	183	Disc Brake Caliper Bushings	178	Fuses	195	Pinion Bearings	159-167	Tie Rods	216-217
Bellhousings	182, 227-228	Disc Brake Caliper Pins	178	Gas Caps	211	Pinion Seals	159-168	Timing Chains	199
Blackout Lamp Bracket	145	Disc Brake Caliper Pistons	177	Gas Gauges	188	Pintle Hook	143-149	Timing Covers	199
Blackout Lamp Bucket	143	Disc Brake Caliper Seals	177	Gas Tank Sending Units	210	Piston Rings	198	Timing Sets	199
Blower Motors	212	Disc Brake Caliper Sleeves	178	Gas Tank Straps	210	Pistons	198	Tire Carriers	142
Body Fastener Kits	150-153	Disc Brake Calipers	177	Gas Tanks	210	Pitman Arms	215-217	Tool Compartment Lid	147, 149
Body Handles	143	Disc Brake Pads	178	Gauges	188	Pivot Bolts	218	Tool Compartments	143, 145
Body Kits	142-150	Disc Brake Rotors	177	Glove Box Doors	141	Plugs	151, 153	Toolbox	133
Body Mount Kits	142-150	Disc Brake Splash Shields	177	Glove Box Inserts	141	Power Brake Boosters	172	Top Bows	143-147
Body Panels	142-147	Distributor Caps	193	Glove Box Locks	139	Power Brake Units	172	Tow Hooks	154, 156
Body Tubes	133, 142-150	Distributor Condensers	193	Glovebox Light Switch	192	Power Steering Gear Boxes	213	Track Bars	220
Brake Boosters	172	Distributor Drive Gears	199	Grille Covers	152	Power Steering Hoses	214	Trac-Lok	164-168
Brake Caliper Pistons	177	Distributor Rotors	193	Grille Inserts	154	Power Steering Pump Seals	214	Trailer	143
Brake Caliper Seals	177	Distributor Sensors	193	Grille Supports	154, 156, 158	Power Steering Pumps	214	Transfer Case Crossmember	155
Brake Calipers	177	Distributor Switch Plates	193	Grilles	133, 146, 149, 156	Power Steering Return Hoses	214	Transfer Case Drive Chains	223
Brake Drums	174	Distributors	193	Grommets	139	Push Rods	200	Transfer Cases	221-224, 234
Brake Hoses	179	Door Footman Loops	138	Hardtop Seals	137	Quadra-Trac	221	Transmission Mounts	225-231
Brake Light Switches	192	Door Glass Edge Seals	136	Header Panels	156, 158	Radiator Caps	184	Tremec T150/T176/T177	227
Brake Lines	179	Door Glass Inner Seals	136	Headers	203	Radiator Clamps	184	Tune-Up Kits	195
Brake Master Cylinders	172	Door Glass Outer Seals	136	Headlight Bezels	134	Radiator Fan Shrouds	185	Turn Signal Switches	192
Brake Pads	178	Door Handles	138	Headlight Buckets	143	Radiator Fans	185	Turn Signals	145
Brake Pedal Pads	180	Door Inserts	153	Headlight Hardware	134	Radiator Hoses	187	U-Bolts	159-166, 218-235
Brake Pedals	180	Door Latch Brackets	138	Headlight Housings	134	Radiator Overflow Bottles	184	U-Joints	159, 170
Brake Rotors	173, 177	Door Latch Pins	138	Headlight Knobs	192	Radiators	184	Upper Gasket Sets	197
Brake Shoes	174	Door Latch Plates	138	Headlight Switches	192	Radio Antennas	195	Upper Radiator Hoses	187
Brake Splash Shields	173, 177	Door Locks	139, 155-156, 158	Headlights	134	Radio Bracket	145	Valve Cover Gaskets	196
Breathers	208	Door Paddle Handles	138	Heater Cables	212	Relays	192	Valve Cover Grommets	196
Bulbs	134-135	Door Panel Grommets	139	Heater Cores	212	Ring & Pinion Gears	159-168	Valve Covers	133, 196
Bumper	155	Door Seals	136	Heater Hoses	187	Rocker Arm Bridges	200	Valve Lifters	199
Bumper Covers	157	Door Straps	139	Heater Switches	212	Rocker Arm Pivots	200	Valve Springs	200
Bumper End Caps	155	Door Window Seals	136	Hood Catches	153	Rocker Arm Shafts	200	Valve Stem Seals	200
Bumper Extensions	153	Drag Links	216-217	Hood Support Struts	156, 158	Rocker Arms	200	Voltage Regulators	191
Bumper Guards	155	Driveshafts	170-171	Hoods	142-158	Rotors	173	Voltmeters	188
Bumpers	143-157	Driving Lights	134	Horn Buttons	214	Seals	136-137, 151, 153	Wamer T14/T15/T18	226
Camshaft Bearings	199	Drum Brake Hardware	176	Horns	195	Seat Belts	141	Wamer T4/T5	228
Camshaft Gears	199	Drum Brake Hold Down Hardware	175	Hose Clamps	211	Seat Frames	142, 144, 146	Wamer T84	226
Camshaft Position Sensors	189	Drum Brake Cable Guides	176	Hoses, Power Steering	214	Serpentine Belts	187	Wamer T90	225
Camshafts	199	Drum Brake Self Adjusting Cables	176	Hub Bearings	173	Shackle Brackets	218-219	Washer Fluid Level Sensors	190
Carburetors	207	Drum Brake Adjusting Hardware	176	Hub Caps	173	Shackles	220	Water Pumps	186
Catalytic Converters	205	Drum Brake Self Adjusting Levers	176	Hub Seals	173	Shift Boots	221-223	Weatherstrip	136-137, 155
Cat-Back Exhaust Kits	205	Drum Brake Self Adjusting Screws	176	Hubs	169, 174	Shift Forks	224-230	Wheel Bearings	167
Choke Cables	207	Drum Brake Shoe Anchor Cams	174	HVAC Door Levers	212	Shift Knobs	225-231	Wheel Cylinders	175
Chrysler 8.25" Axle	167	Drum Brake Shoe Anchor Springs	174	Hydra-Lok	168	Shift Rods	223	Wheel Housings	151-152
Clocks	188	Drum Brake Shoe Anchor Pin Kits	174	Idle Air Control Motors	208	Shocks	218-219	Wheel Studs	164-167, 174
Cluster Gears	229-231	Drum Brake Equalizer Springs	175	Idle Cross Shafts	183	Shovel Bracket	143, 145	Wheels	143-147
Clutch Covers	181	Drum Brake Shoe Cups	175	Idler Pulleys	185	Side Marker Lights	135	Window Cranks	138
Clutch Discs	181	Drum Brake Shoe Springs	175	Ignition Coils	194	Side Mirrors	154, 158	Window Regulators	138
Clutch Fork Boots	183	Drum Brake Shoe Return Springs	175	Ignition Locks	194	Side Panels	142-152	Windshield Frames	133, 142-152
Clutch Forks	183	Drum Brake Springs	176	Ignition Modules	194	Slip Yoke Eliminator	171	Windshield Seals	136
Clutch Kits	181	EGR Valves	208	Ignition Switches	194	Soft Top Seal Hardware	137	Windshield Washer Pumps	232
Clutch Linkage	183	Emergency Brake Cables	180	Ignition Wires	194	Soft Top Seals	137	Wiper Arms	232
Clutch Master Cylinders	182	Emergency Brake Equalizer Bars	180	Inner Door Handles	139	Solenoids	191	Wiper Blades	232
Clutch Pedal Covers	183	Emergency Brake Levers	180	Input Shafts	229-231	Spare Tire Carrier	145-149	Wiper Motors	145, 147, 149, 232
Clutch Pedals	183	Emergency Brake Springs	180	Intake Guides	200	Spark Plugs	194	Wiper Switches	192, 232
Clutch Pilot Bushings	182	Engine Kits	197	Intake Manifold Gaskets	204	Speedometer Cables	188	Wiring Harnesses	191
Clutch Rods	183	Engine Mounts	202	Intake Manifolds	197, 203	Speedometer Gears	188	Yokes	159-170, 221-224
Clutch Slave Cylinders	182	Engine Oil Lines	201	Intake Temperature Sensors	189	Speedometers	188		
Coil Springs	220	Exhaust Clamps	199	Intake Valves	200	Speedometers Gears	221		
Condensers	193	Exhaust Guides	200	Interior Door Handles	141	Spider Gears	159-167		
Connecting Rod Bearings	198	Exhaust Hangers	205	Interior Rearview Mirrors	141	Spindle Nut Socket	160		
Connecting Rods	198	Exhaust Headers	203	Intermediate Pipes	205	Spindles	159-160		
Control Arms	220	Exhaust Insulators	205	Jerry Can Bracket	143-145, 209	Spreader Bars	152		
Cooling Fans	185	Exhaust Manifold Gaskets	204	King Pins	159	Spring Bolts	218-219		
Cowl Panels	142, 144	Exhaust Manifolds	203	Knock Sensors	190	Spring Plates	218-219		
Cowls Seals	136	Exhaust Pipe Gaskets	204	Knuckles	159	Starter Solenoids	191		

WIN A TRIP TO THE 2010 SEMA SHOW IN LAS VEGAS!

FLIGHT | HOTEL | ENTERTAINMENT

GRAND PRIZE WINNER WILL RECEIVE:
ROUND TRIP AIR FARE
4 NIGHTS IN A 4-5 STAR HOTEL
PASS TO NIGHT CLUB & SPA TREATMENT
AND OF COURSE THE SEMA SHOW
AND MUCH, MUCH MORE!

WELCOME TO Fabulous LAS VEGAS NEVADA

5 LUCKY WINNERS WILL GO TO 2010 SEMA SHOW, THE WORLD'S LARGEST AND MOST EXCITING AFTERMARKET EVENT, IN LAS VEGAS AS OMIX-ADA'S GUESTS

REGISTER TO WIN (NO PURCHASE NECESSARY); MUST REGISTER BY SEPT 1, 2010 AT WWW.OMIX-ADA.COM



SEE NEW AND CONCEPTUAL CARS & PARTS IN ACTION!



HIT THE NIGHT LIFE & ENJOY THE VEGAS SCENE!



ENJOY YOUR STAY IN A WORLD FAMOUS RESORT & LUXURIOUS SPA!

SEMA SHOW

NOVEMBER 2-5, 2010
LAS VEGAS CONVENTION CENTER
LAS VEGAS, NEVADA USA

www.omix-ada.com



FEATURED

PERFORMANCE PARTS & ACCESSORIES



NEW

- 1. Flat Fenders** Pg.16
- 2. HID Lights** Pg.90
- 3. JK Light Bar** Pg.93
- 4. XHD Tube Ends** Pg.05
- 5. Synthetic Rope Winch** Pg.79
- 6. Cowl Body Armor** Pg.74

- 6. Body Armor** Pg.74
- 7. Euro Guards** Pg.16
- 8. Grille Inserts** Pg.90
- 9. Hinge Sets** Pg.70
- 10. Hood Kits** Pg.93
- 11. Hood Scoop** Pg.05
- 12. Locking Gas Cap** Pg.72
- 13. Mirror Relocation Kit** Pg.53
- 14. Recess Door Guards** Pg.79
- 15. Side Bars** Pg.16
- 16. Wheels** Pg.22
- 17. XHD Bumper** Pg.05

Omix-ADA, Inc/Rugged Ridge

460 Horizon Drive, Suite 400
Suwanee, GA 30024 USA
Phone: (770) 614-6104
Fax: (770) 614-6069

www.omix-ada.com
www.ruggedridgeoffroad.com
www.outlandautomotive.com
www.alloyusa.com
www.precisiongear.com

